

MECHANICAL FAUCETS

SH-TK1-02-100



Tub and Showers

Product Type

Wall Mounted Pressure Balancing Tub and Shower Trim Kit with Shower Head and Diverter Tub Spout

Features & Specifications

- Pressure Balancing
- 5-3/8" Tub Spout with Diverter
- 2.5 GPM Max. Flow Rate @ 80 PSI Shower Head with Ball Joint
- Includes Showerhead Arm and Wall Flange
- Embossed and Color Coded Indexing on Wall Plate
- 1910-002KJKCP Shower Valve Trim

Warranty

- Lifetime Limited Faucet Warranty
- 5-Year Limited Cartridge Warranty
- 1-Year Limited Finish Warranty

Job Name _____

Item Number _____

Section/Tag _____

Model Specified _____

Architect _____

Engineer _____

Contractor _____

Submitted as Shown Submitted with Variations

Date _____



2100 South Clearwater Drive
Des Plaines, IL
P: 847/803-5000
F: 847/803-5454
Technical: 800/TEC-TRUE
www.chicagofaucets.com

Architect/Engineer Specification

Chicago Faucets No. SH-TK1-02-100, Wall Mounted Pressure Balancing Tub and Shower Trim Kit with Shower Head and Diverter Tub Spout, Chrome Plated solid brass construction. 5-3/8" Center to Center Tub Spout with Diverter. 2.5 GPM Max. Flow Rate @ 80 PSI Shower Head with Ball Joint. Includes Showerhead Arm and Wall Flange. Embossed and Color Coded Indexing on Wall Plate. 1910-002KJKCP Shower Valve Trim. .

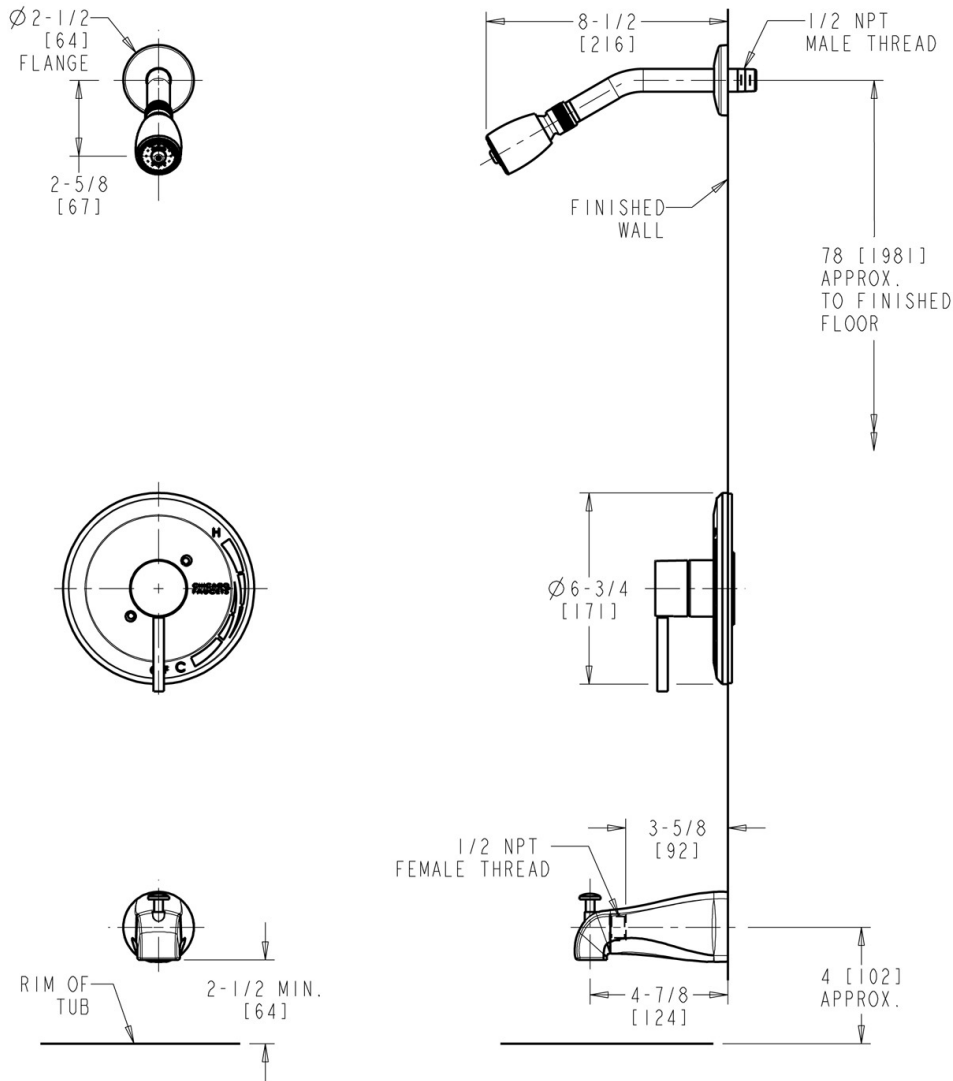

Operation and Maintenance

Installation should be in accordance with local plumbing codes. Flush all pipes thoroughly before installation. After installation, remove spout outlet or flow control and flush faucet thoroughly to clear any debris. Care should be taken when cleaning the product. Do not use abrasive cleaners, chemicals or solvents as they can result in surface damage. Use mild soap and warm water for cleaning and protecting the life of Chicago Faucet products. For specific operation and maintenance refer to the installation instructions and repair parts documents that are located at www.chicagofaucets.com.

Chicago Faucets, member of the Geberit Group, is the leading brand of commercial faucets and fittings in the United States, offering a complete range of products for schools, laboratories, hospitals, office buildings, food service, airports and sport facilities. Call 1.800.TECTRUE or 1.847.803.5000 Option 1 for installation or other technical assistance.



2100 South Clearwater Drive
Des Plaines, IL
P: 847/803-5000
F: 847/803-5454
Technical: 800/TEC-TRUE
www.chicagofaucets.com