



Position	Count	Description	Unit price
	-1	<p>TP 40-160/2 B U-G-Z-BUBE</p>  <p>Product photo could vary from the actual product</p> <p>Product No.: 96411801 Single-stage centrifugal in-line single-head pump.</p> <p>The in-line design with opposite suction and discharge ports enables mounting in pipework or on a concrete foundation.</p> <p>The shaft seal is a corrosion-resistant maintenance-free mechanical seal.</p> <p>The motor is a 3-phase AC motor.</p> <p>Liquid: Liquid temperature range: 5 .. 284 °F Liquid temp: 68 °F</p> <p>Technical: Speed for pump data: 3450 rpm Actual calculated flow: 59.4 US gpm Resulting head of the pump: 35.7 ft Shaft seal: BUBE Maximum operating pressure: 145 psi Approvals on motor nameplate: UL Recognized Component, CSA</p> <p>Materials: Pump housing: Bronze DIN W.-Nr. 2.1093 Impeller: Stainless steel DIN W.-Nr. 1.4301 AISI 304</p> <p>Installation: Maximum ambient temperature: 104 °F Maximum operating pressure: 145 psi Flange standard: USA Pipe connection: 1 1/2"</p> <p>Electrical data: Motor type: Baldor, TEFC</p>	On request



Company name: -
 Created by: -
 Phone: -
 Fax: -
 Date: -

Position	Count	Description	Unit price
		Number of poles: 2 Rated power - P2: 0.738 HP Main frequency: 60 Hz Rated voltage: 3 x 208-230/460 V Service factor: 1,25 Rated current: 2,7-2,6/1,3 A Starting current: 16,8-15,2/7,6 A Cos phi - power factor: 73 Rated speed: 3450 rpm Motor efficiency at full load: 74 % Insulation class (IEC 85): B Others: Net weight: 67.9 lb Gross weight: 75.2 lb Shipping volume: 1.98 ft ³	

Description	Value
Product name:	TP 40-160/2 B U-G-Z-BUBE U-G-Z BUBE
Product Number:	96411801
EAN number:	5700390524265
Technical:	
Speed for pump data	3450 rpm
Actual calculated flow:	59.4 US gpm
Resulting head of the pump:	35.7 ft
Head max:	52.5 ft
Shaft seal:	BUBE
Maximum operating pressure	145 psi
Approvals on motor nameplate:	UL Recognized Component, CSA
Pump Number:	96405258
Pump version:	U
Materials:	
Pump housing:	Bronze DIN W.-Nr. 2.1093
Impeller:	Stainless steel DIN W.-Nr. 1.4301 AISI 304
Material code:	Z
Installation:	
Maximum ambient temperature:	104 °F
Maximum operating pressure	145 psi
Flange standard:	USA
Connect code:	G
Pipe connection:	1 1/2"
Liquid:	
Liquid temperature range	5 .. 284 °F
Liquid temp:	68 °F
Electrical data:	
Motor type:	Baldor, TEFC
Number of poles:	2
Rated power - P2:	0.738 HP
KVA code:	K
Main frequency:	60 Hz
Rated voltage:	3 x 208-230/460 V
Service factor:	1,25
Rated current:	2,7-2,6/1,3 A
Starting current	16,8-15,2/7,6 A
Load current:	3,1-3/1,5 A
Cos phi - power factor:	73
Rated speed:	3450 rpm
Motor efficiency at full load:	74 %
Insulation class (IEC 85):	B
Motor protection:	NONE
Motor Number:	85600003
Others:	
Net weight:	67.9 lb
Gross weight:	75.2 lb
Shipping volume:	1.98 ft³
Country code:	Namreg

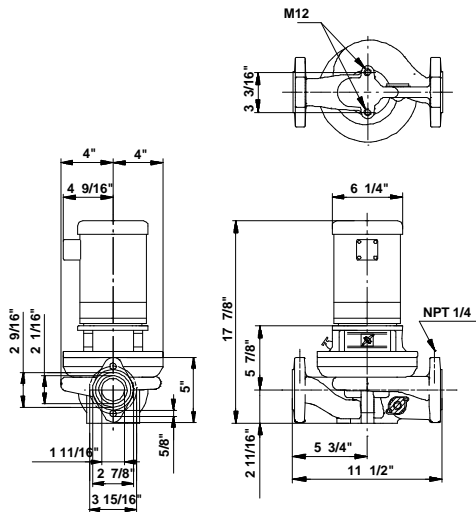
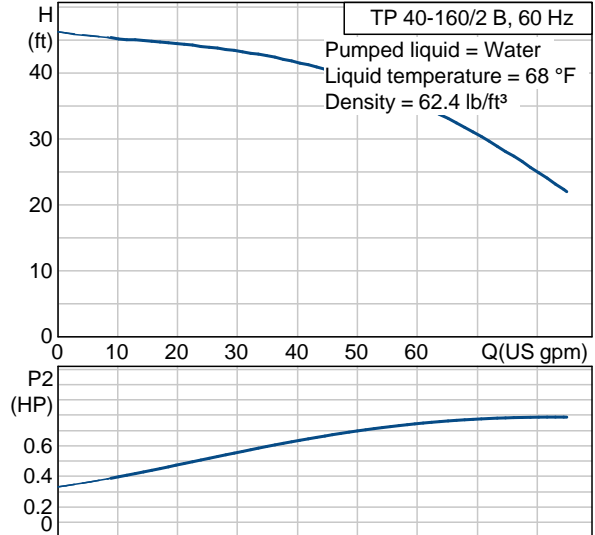

96411801 TP 40-160/2 B 60 Hz

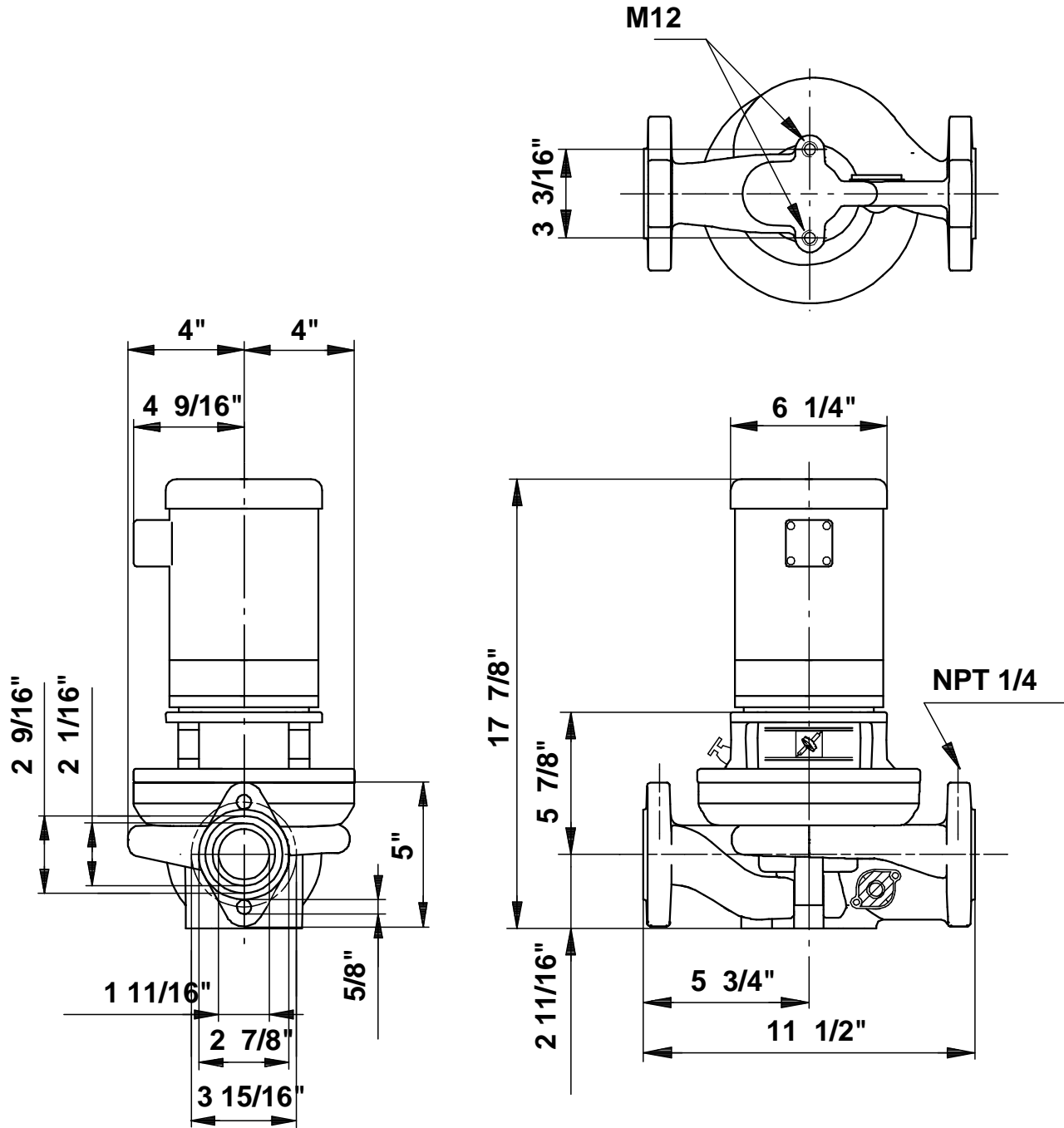

Note! All units are in [mm] unless others are stated.
 Disclaimer: This simplified dimensional drawing does not show all details.