



Submittal Sheet

Part Description:
 8" PVC WHITE Sewer 45 Degree (1/8) Bend
 or Elbow H X H

Part Number:
 414188BC

Approvals and Listings maintained by:
Canplas Industries Ltd
 Canada: 1-800-461-5300 USA: 1-888-461-5307

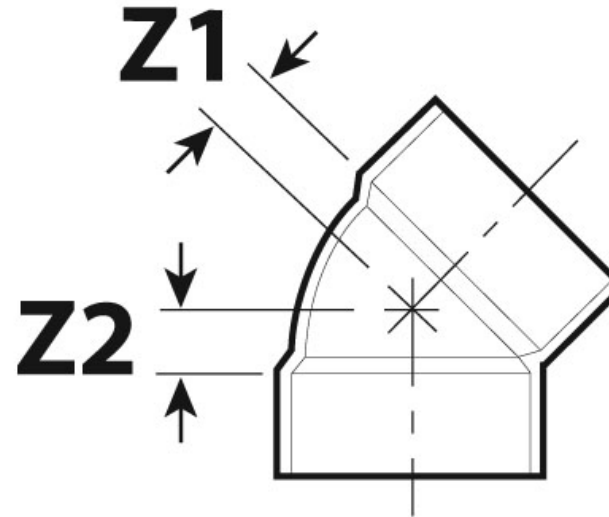

Part #	Part UPC	Colour	Size (inches)	Ctn Qty	Ctn Bar Code	Ctn. Wt (Kgs)	Ctn. Wt (lbs)	Skid Cubic (m)	Skid Cubic (ft)	Ctns/Skid
414188BC	662671410634	WHITE	8X8	1	20662671410638	2.43	5.35	1.79	63.37	48

Dimensions (inches)

Z1	Z2
1.84	1.92