

Introduction

The Irritrol Climate Logic™ wireless weather sensor system transforms your automatic irrigation control system into a high-efficiency, water resource-management center. Compatible with remote-ready Irritrol and Toro controllers, Climate Logic automatically regulates watering duration corresponding to real-time weather conditions and specific geographic and local weather profile information provided on a region-specific Setup Card. In addition, integral rain and freeze sensing further reduce wasteful, unnecessary irrigation and icing conditions.

Your Climate Logic system consists of a self-contained, Weather Sensor/Transmitter that continuously monitors current air temperature, solar radiation and precipitation. This data is transmitted at regular intervals throughout the day to the Receiver Module; linked directly to your controller's remote control port. Each day, Climate Logic calculates and adjusts the programmed station run time duration to the amount required for the next automatic watering cycle.

The Climate Logic system is designed for easy installation, setup and use. To take full advantage of the features and capabilities provided by the Climate Logic system, take a moment to review the detailed information provided within this guide.

To answer any questions you may have regarding the Climate Logic system, or any Irritrol product, please contact an Irritrol Customer Service representative at 1-800-634-8873.

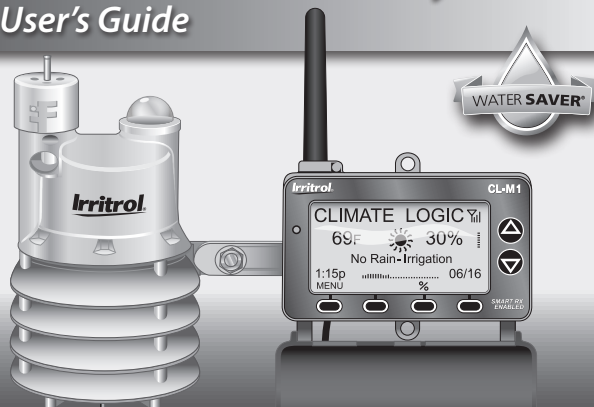

Quick Start Guide	2-3
System Components at a Glance	4-5
CL-M1 Receiver Module	4
CL-W1 Wireless Weather Sensor	5
Climate Logic System Installation	6-11
Receiver Module Installation and Setup	6-8
Weather Sensor Installation and Setup	9-11
Climate Logic System Operation	12-19
Control Feature Setup Options	12
Setup Menu Options	13
Utility Menu Options	14
Water Adjust Feature	15
Rain/Freeze Sensor Control Feature	16
Water History Review Feature	17
Weather Sensor Identification Feature	18
Control System Synchronization	19
Remote PIN Setup	19
Weather Sensor Battery Replacement	20
Specifications	21
FCC Information	22

The Quick-Start guide provides the essential steps required to properly install and setup the Climate Logic system in the most direct route possible. As needed, refer to the detailed information on the page number listed with each step.

- Step 1** – Connect and secure the Receiver Module next to the controller. See *page 6*.
- Step 2** – Adjust controller program **A** for the **hottest/driest conditions expected, without causing over-watering and runoff**. Retain all watering time/day restrictions in the program schedule as required See *page 6*.
- Step 3** – Synchronize the Receiver Module and controller to the current time and date. See *page 7*.
- Step 4** – Insert the Receiver Module **Setup Card** as shown. See *page 8*.
- Step 5** – Establish your location by entering the five-digit ZIP code, or Lat/Lon coordinates as preferred. See *page 8*.

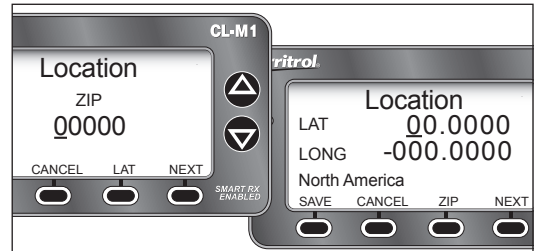
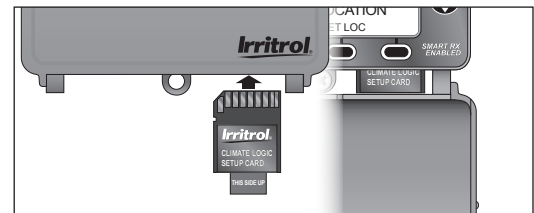
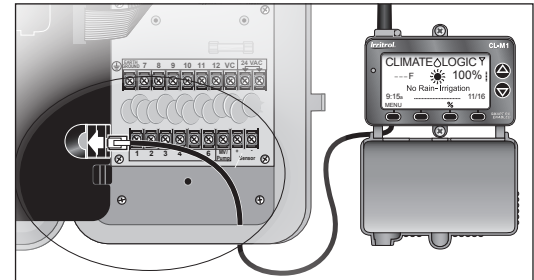

Quick-Start Guide

Step 6 – Press and hold the sensor Test Pin for 10–15 seconds to activate the Weather Sensor!

A red LED (viewable through the lower vent ring) will illuminate twice after 10 seconds to confirm activation (if not already active).

See **page 9**.

Step 7 – Press the sensor Test Pin again to confirm signal reception at the Receiver Module. The receiver's red LED will turn on momentarily when the signal is received. Press the **BYPASS** key to cancel the **Dry-out** mode delay period and resume normal operation. See **page 9**.

Note: If the LED does not turn on, refer to the Weather Sensor setup procedure on **page 19**.

Step 8 – Check the Rain Sensor threshold setting and adjust as needed. See **page 10**.

Step 9 – Secure the Weather Sensor to a rain gutter or other suitable structure that provides unrestricted exposure. Adjust the sensor alignment to vertical. See **page 11**.

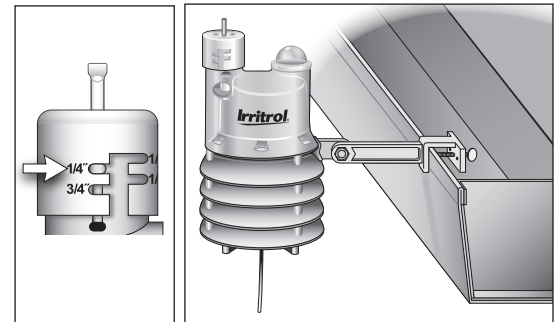
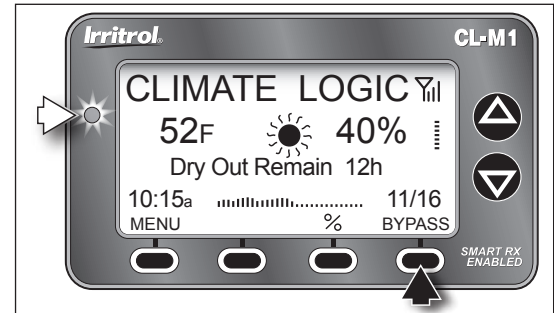
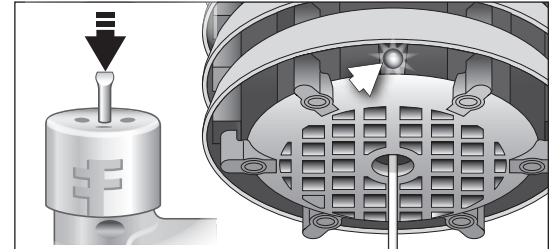

System Components at a Glance

- 1 – Antenna
- 2 – LCD Screen: Large-format LCD screen provides enhanced clarity and use of text and graphics.
- 3 – Up/Down Arrow Keys: Control Menu cursor position, and adjust definable screen values.
- 4 – Setup Card: Provides historical weather data for regional location specified by ZIP code or Lat/Lon coordinates.
- 5 – CMR-ADP KwikDial Adaptor Cable: Adapts RJ25 connector to KwikDial controller's 5-pin receptacle.
- 6 – Cover: Provides weather-resistance and display protection in closed position.
- 7 – Connector Cable: Plugs into controller's remote control receptacle.
- 8 – Multifunction Keys: Key function is configured for each screen as required.
- 9 – LED Status Indicator: Remains On when irrigation is suspended; flashes when bypassed.

CL-M1 Receiver Module

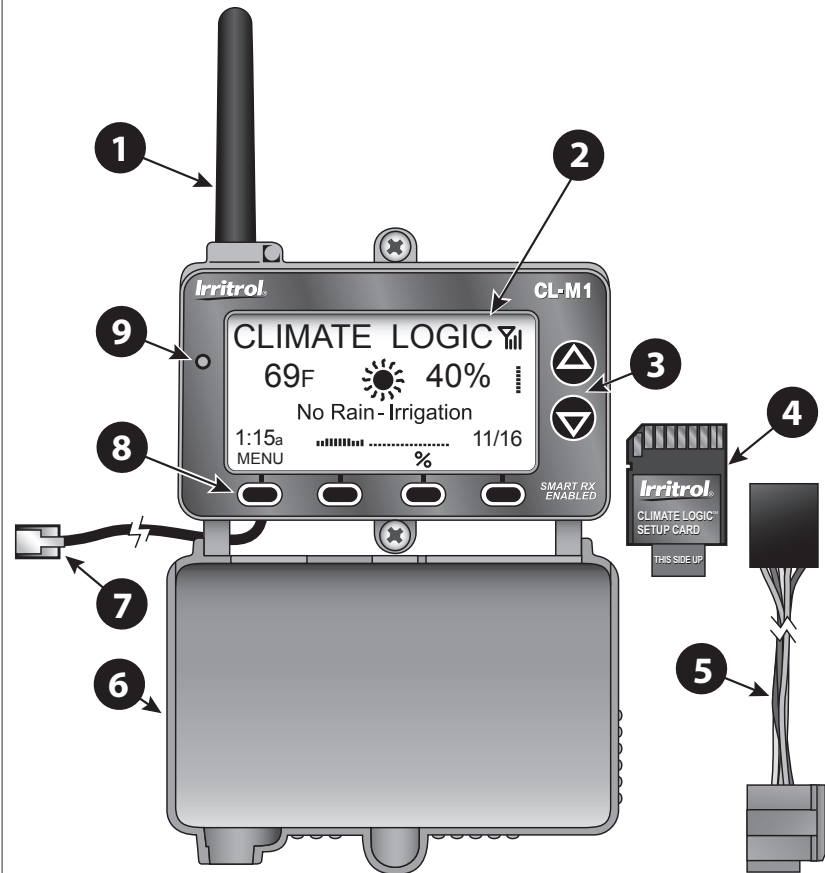

CL-W1 Wireless Weather Sensor

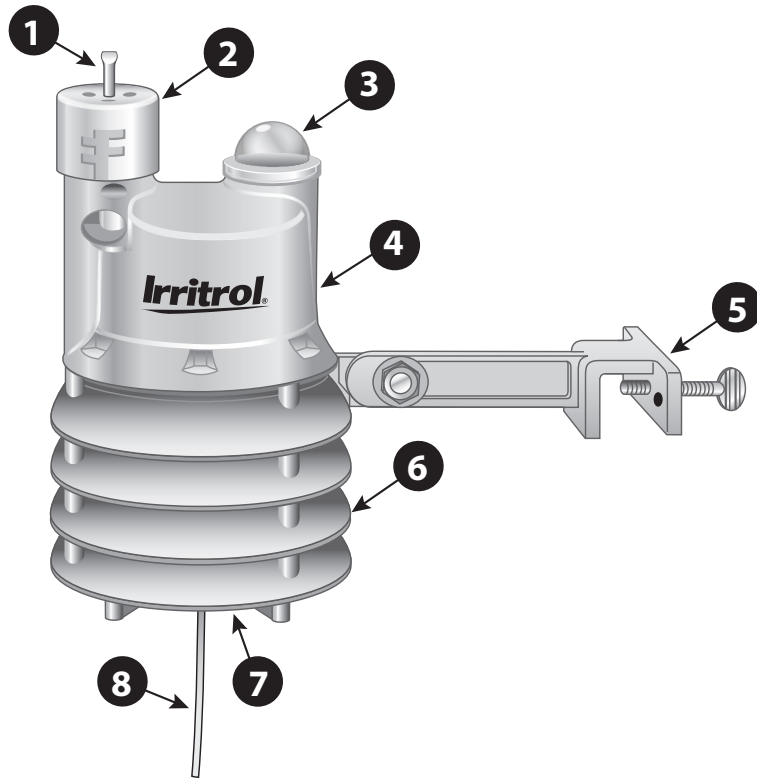

1 – Weather Sensor Test Pin

Pressed to simulate rain sensor operation and test communication.

2 – Rain Sensor Adjustment Cap

Adjusts Rain Sensor threshold to a nominal setting of 1/8", 1/4", 1/2" or 3/4" (3 mm, 6 mm, 12 mm or 19 mm) of accumulated rainfall.

3 – Solar Collector

Collects and measures solar radiation. Requires full exposure to sunlight.

4 – Battery Compartment

Factory-installed 9V-Alkaline battery can sustain normal Weather Sensor operations up to five years.

5 – QuickClip™ Mounting Bracket

Convenient QuickClip mounting bracket provides quick and easy Weather Sensor installation.

6 – Temperature Sensor (not shown)

7 – RF Transmission LED (not shown)

8 – Antenna Wire

Note: Installation methods must comply with all applicable national and local building codes.

1. Setup controller watering Program **A** to provide an irrigation baseline for the Climate Logic system. The station run time, cycle start time(s), and watering day schedule* must be configured for the **hottest/driest conditions expected, without causing over-watering and runoff**. Retain all watering time/day restrictions in the program schedule as required.

Note: By default, Climate Logic modifies the run time of stations assigned only to Program **A**. To include Program **B**, or Programs **B** and **C**, see **page 13**.

***Note:** For TMC-212 controller only: Interval day scheduling is not compatible with Climate Logic. Calendar and Odd/Even schedules are not affected.

2. Route the connection cable into the controller cabinet. Insert the cable connector into the controller's remote control jack.

Note: Use the provided CMR-ADP cable adapter assembly for KwikDial and MC-E (Blue) controller applications.

3. Secure the Receiver Module to the wall next to the controller using the provided screws or other suitable fasteners.

Note: For indoor application, adhesive-backed hook and loop tape (not included) can be used instead of screws.

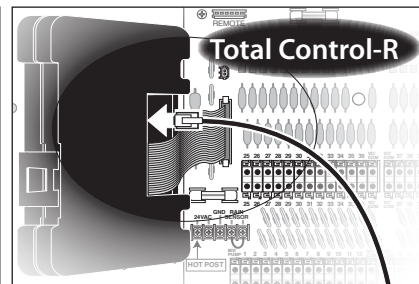
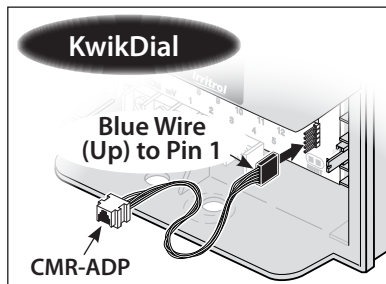
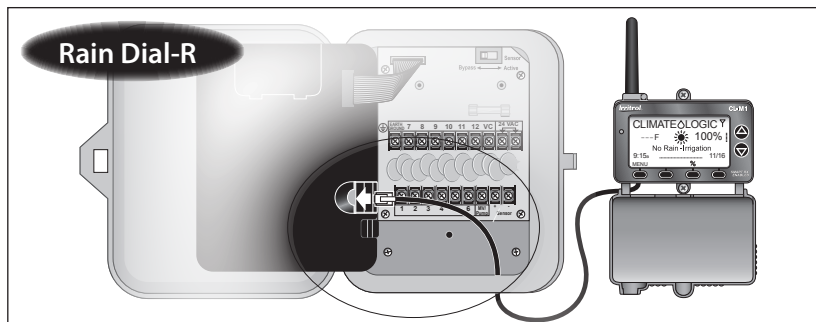

- The Receiver Module will automatically* synchronize time and date with the host controller upon initial power-up.



**Note: Does not apply to TMC-212 controller.*

- Verify that the time and date are synchronized correctly. If necessary, adjust the Receiver Module as follows:

Note: The display will automatically return to the **Home** screen if a key is not pressed within 60 seconds.

- Press the **MENU** key to display the Main Menu screen. (The **CLOCK** menu option is selected by default.)
- Press the **ENTER** key to display the **Clock** review screen.
- Press the **SETUP** key to display the **Set Clock** screen.

Note: To download the current time and date from the controller, press the **GET** key. When prompted, press the **YES** key.

- Press the  or  key to adjust the selected (underscored) value. Press the **NEXT** key to select the next value. Continue setting the current day, year and time.

Note: To change the clock time display format, press the **12/24** key. To return to the previous screen without making changes, press the **CANCEL** key.

- When the Receiver Module and controller are synchronized to the current time and date, press the **SAVE** key.
- Press the **EXIT** key two times to return to the **Home** screen.

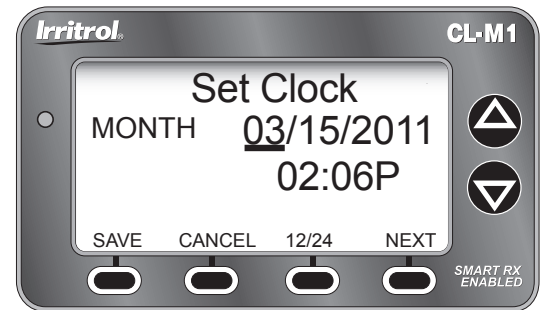
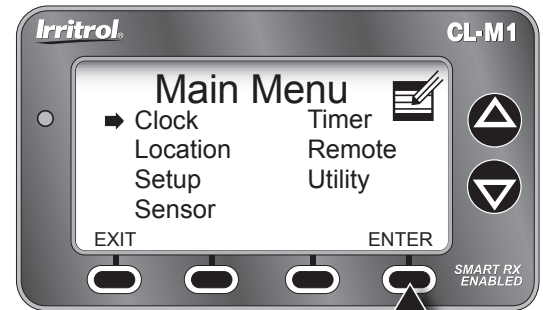

6. With the cover closed, insert the **Climate Logic Setup Card** into the Receiver Module slot as shown. Open the cover to proceed.

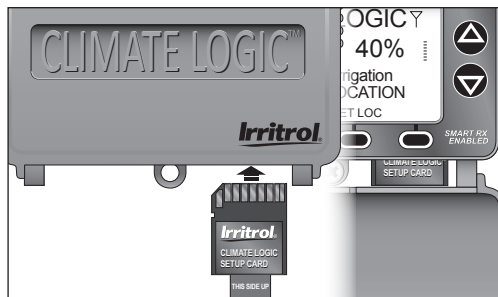



Note: The **Home** screen (right) will be displayed

only when a location has not been established, or has been erased. Press the **SET LOC** key to display the **Location** screen.

7. Establish the site location as follows:

- Press **MENU** ⇒ **LOCATION** ⇒ **ENTER** to display the **Location** screen.

Note: The **Lat/Lon Location** screen will be displayed by default. To set the location using a 5-digit **ZIP** code, press the **ZIP** key.

- Press the  or  key to adjust the selected value. Press the **NEXT** key to select the next value in sequence.
- When the location information is displayed correctly, press the **SAVE** key.

Note: The Receiver Module will begin transferring specific data from **Setup Card** for the defined location. A confirmation screen will indicate the completed transfer.

- Press the **EXIT** key (two times) to return to the **Home** screen.

8. Remove the **Setup Card** and stow inside the controller cabinet.

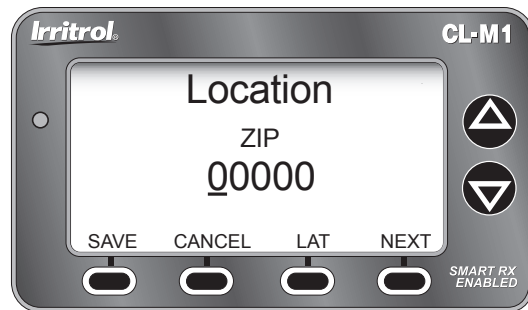
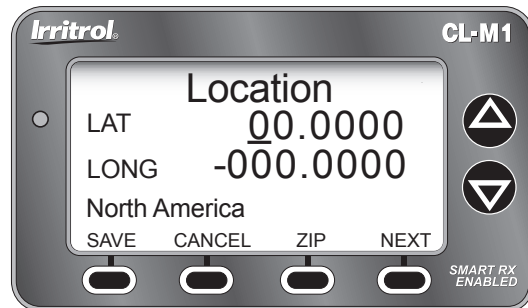
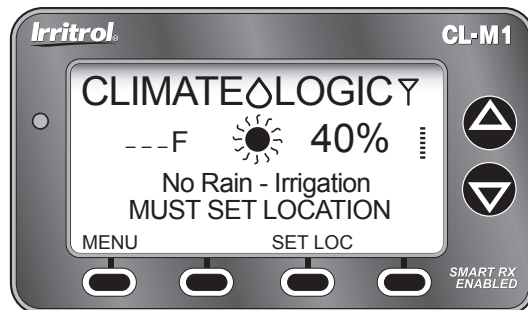

Weather Sensor Installation and Setup

⚠ Important: The Climate Logic Weather Sensor is shipped with the battery circuit deactivated. To initially activate the sensor prior to installation, press and hold the Test Pin for 10–15 seconds. A red LED, viewable from the lower vent area, will illuminate twice after 10 seconds (if not already active).

Note: The Weather Sensor and Receiver Module are paired for wireless communication from the factory. The following procedure will only be required if **Please Add Sensor** is displayed on the **Home** screen.

1. Pair the Weather Sensor transmitter with the Receiver Module to establish wireless communications as follows:
 - From the **Home** screen, press the **ADD-SEN** key to display the **Sensor Setup** screen. Press the **ADD** key to initiate the sensor ID search function.
 - Press and release the **Test Pin** to “Ping” the Receiver Module. When pairing is successful, the 7-digit sensor ID is displayed.

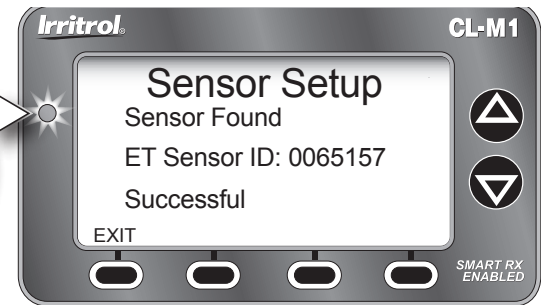
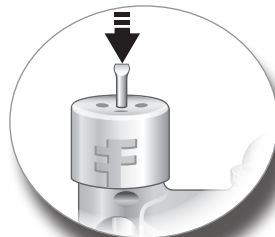
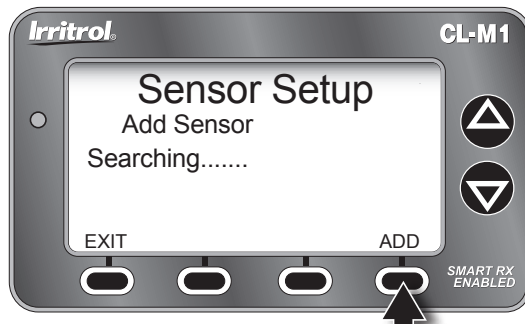
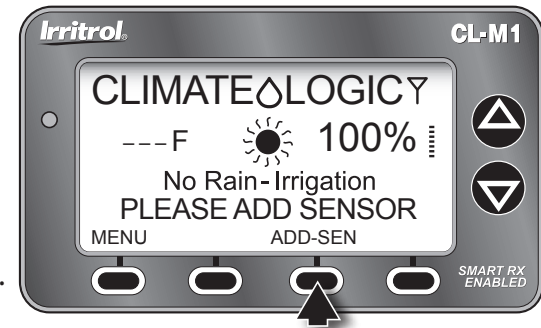
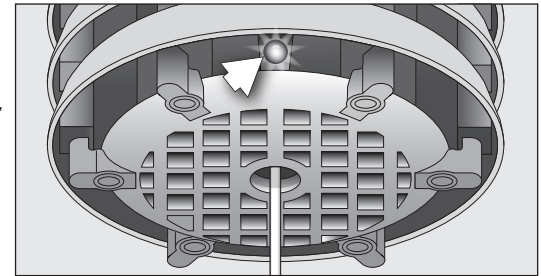

- Press the **EXIT** key (three times) to return to the **Home** screen. After a brief time, the current temperature, watering history graph line, and signal-strength bars will be displayed.

Note: A single Weather Sensor can be paired to multiple Receiver Modules when additional Climate Logic systems are installed within reception range.

2. The **Rain Sensor** default threshold is $\frac{1}{4}$ " (6 mm) of accumulated rainfall (nominal). The threshold can be lowered to $\frac{1}{8}$ " (3 mm) or raised to $\frac{1}{2}$ " (12 mm), or $\frac{3}{4}$ " (19 mm) as preferred. Prior to installing the Weather Sensor, adjust the threshold to the preferred setting as follows:

Note: Increasing the threshold extends the length of time required for the Weather Sensor to signal the Receiver Module to stop irrigation, as well as extending the dry-out period before scheduled watering can resume. In areas where heavy fog, mist or high humidity is common, the $\frac{1}{8}$ " (3 mm) setting is not recommended due to the increased sensitivity to moisture.

- Turn the Rain Sensor cap slightly, releasing it from the retention pins, allowing the cap to move vertically.
- Turn the cap to engage the retention pins at the preferred slot position.

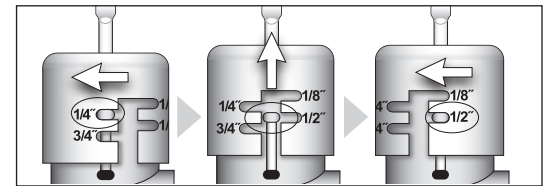
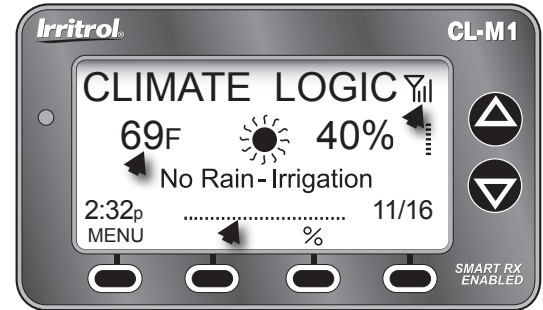

⚠ Important: The Weather Sensor must have full exposure to sun, wind and rain, and must not be installed inside a rain gutter, or in any location where immersion, runoff, or contact with irrigation spray will occur. Avoid installation near a heat source, such as a heater vent or chimney. Wooden surfaces are preferred to concrete or asphalt shingles to reduce reflected heat. Installation over a planted area is preferred to a driveway, walkway etc. Avoid installation near any large metal structure, or high current-draw equipment that can cause signal interference. Ensure the antenna wire hangs vertically without contact.

3. The Climate Logic system is designed to provide effective wireless communication in most applications. Loss of range can result from interference in the signal path. To verify signal reception from the selected installation site, perform the following test:

- Start a manual watering operation of a zone that can be seen from the installation site. Press and hold the Sensor Test Pin. If the signal is received, watering should shut off within a short time.
- Note the signal bars on the Home screen to verify good signal strength. *Three bars is optimal.*
- Press the **BYPASS** key to cancel the **Dry-out** delay mode to resume normal operation.

4. Install the Weather Sensor using either of the following methods:

- For rain gutter installation, unscrew the bracket thumbscrew enough to clear the rain gutter edge. Holding the Weather Sensor in position, tighten the thumbscrew securely.
- For wood structure installation, remove the thumbscrew and secure the bracket using the provided screws or appropriate stainless fasteners.
- Adjust the vertical alignment as needed by loosening the phillips screw at the bracket joint; adjust to vertical, then tighten securely.

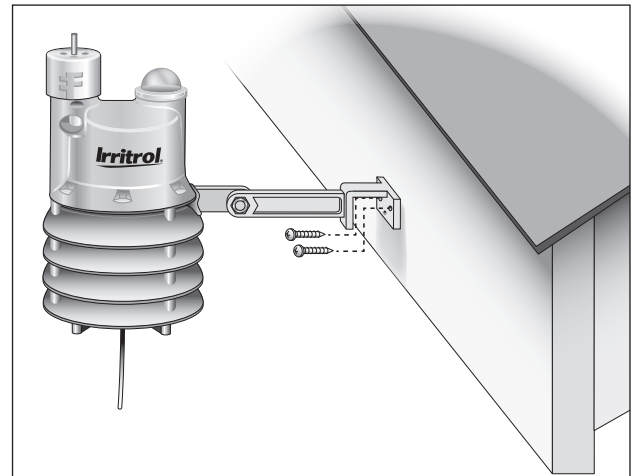
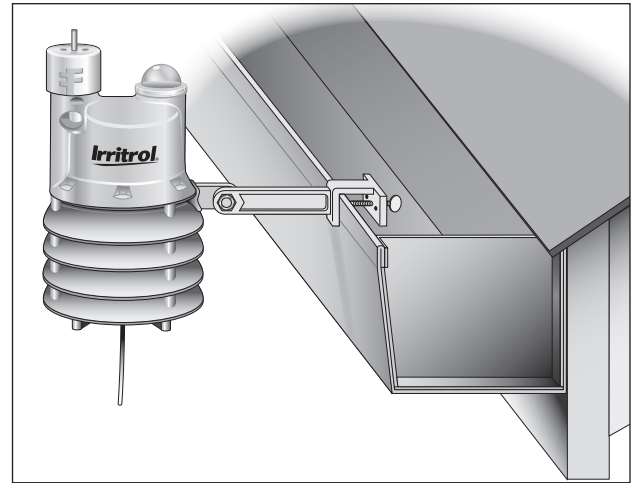

The Climate Logic system control features, accessible through the **Setup** and **Utility** menu screens, determine how and when the system displays information and performs various functions that regulate weather-defined automatic irrigation. The control feature-set, listed below in menu order, includes the factory default setting and the setup parameter for each.

Setup Menu Features	Default	Setup Parameter
Auto Program Adjust	Program A	Program A, A & B or A, B & C
Water Restriction Start Time	None	Any hour
Water Restriction Duration	None	0–24 hours (in ½-hour increments)
Schedule Update Time	8:00 p.m.	Any hour
Average Percent Days	3	1–7 Days
Freeze Temperature	39° F (4° C)	35°–45° F (in 2° increments)
Dry-out days	0.5	0–3 days (in ½-day increments).

Utility Menu Features	Default	Setup Parmater
Contrast	Balanced	Increase/Decrease (incremental)
Units (of measure/time format)	English, 12H	Metric, 24H

Note: History, Default, Loader, and About utility menu items are provided for reference and service use only, and do not provide user-defined setup options. Refer to page 17 for detailed History feature information.

Setup Menu Options

The following **Setup** features are accessed through the **ET Setup** menu (**MENU** ⇒ **SETUP** ⇒ **ENTER**).

All setup parameters are selected, adjusted and entered using the **NEXT/BACK**, **▲**/**▼** and **SAVE** keys.

Auto Program Adjust: In all cases, Climate Logic regulates the run time of all stations assigned to Program A. The Auto Program Adjust feature enables stations assigned to Program B, or Programs B and C to be regulated as well.

Watering Restriction Setup: This feature enables the Climate Logic system to restrict watering for a specified daily time period. The restriction-period start time can be set to any hour of the day. The duration period can be set from 0 to 24 hours, in 30-minute increments.

Schedule Update Time: The Weather Sensor transmits weather-related data to the Receiver Module at regular intervals throughout the day. At the default time of 8:00 p.m., the watering adjustment factor for the next 24 hours is calculated and updated on the **Home** screen. The Schedule Update Time can be set to any hour of the day, but is recommended to occur between scheduled watering operations.

Average Percent Days: This setting defines how many days of compiled weather data are used to calculate the current watering adjustment % factor. By default, Climate Logic compiles data from the three previous days to provide a moderately smooth adjustment factor. This feature can be adjusted from 1 to 7 days. Decreasing the number of days, increases the adjustment variation; increasing the number of days results in less variation and a smoother daily average.

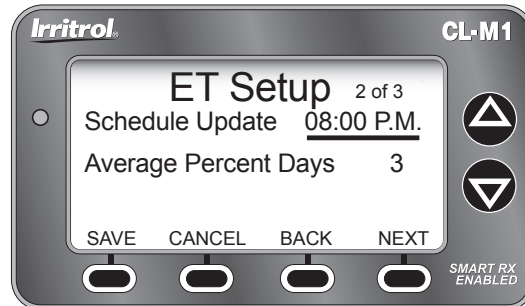
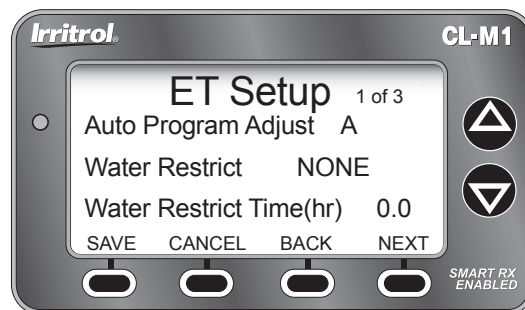

Freeze Temperature (threshold): The freeze sensor activation threshold can be adjusted from 39 °F, (default) down to 35 °F, or increased to 45 °F, in 2° increments.

⚠ Important: Freeze sensor operation should be used only when the watered area can be visually monitored. While the Freeze Sensor is designed to cancel watering when air temperature is near freezing, automatic watering can occur in certain circumstances. For example, the air temperature may rise slightly above the sensor threshold, while the temperature of the adjacent walkways remains below freezing.

Watering in this condition can result in unsafe walkway conditions. The Freeze Sensor feature is not intended to replace any winterization procedures normally used to prevent freeze-related irrigation system damage.

Dry-out Days: This setting determines the minimum length of time that must elapse after the release of a rain/freeze hold, and automatic watering can resume. By default, the dry-out period is ½ day (12 hours), and is adjustable from 0 to 3 days in ½-day increments.

Utility Menu Options

The following **Utility** features are accessed through the **Utility Menu** screen (MENU ⇒ UTILITY ⇒ ENTER).

Display Contrast (CONTRAST ⇒ ENTER): The LCD screen contrast is factory set at the midpoint adjustment range. Contrast intensity can be adjusted incrementally to the preferred level.

Units: (UNITS ⇒ ENTER): By default, all units of measure are displayed in English standard format, and time in 12-hour (a.m./p.m.) format. Metric units of measure, and/or 24-hour (military time) formats can be selected as preferred.

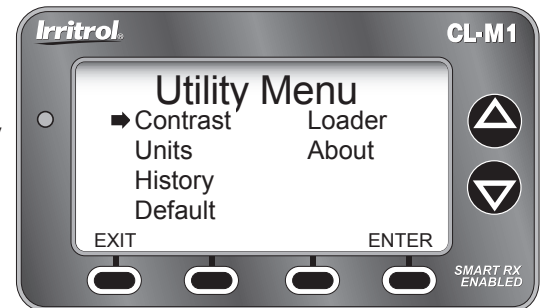
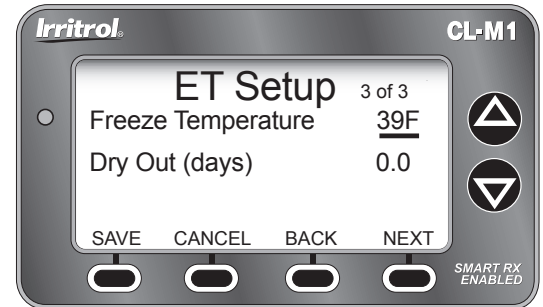



Default (DEFAULT ⇨ ENTER): The Default utility feature enables all user-defined setup parameters to be either erased and reset to the factory default settings, or a **complete system reset including Location, History, and Sensor Pairing.***

- Press the **YES** key to reset to the **Factory Default** settings.
See Default settings listed on page 12.
- Press the **NO** key to return to the previous screen.
- Press the **ERASE** key to display the **Erase All** prompt screen.
 - Press the **NO** key to return to the **Utility Menu** screen.
 - Press the **FACTORY** key to return the **Factory Reset** screen.
 - *Press the **YES** key to initiate the **complete system reset**.
Complete the procedure as indicated on the prompt screens.

Water Adjust Feature

The Water Adjust feature enables watering time to be fine-tuned by applying small adjustments universally to all weather-regulated stations.

From the **Home** screen, press the  or  key to access the **Water Adjust** screen and to adjust scale. Press the **SAVE** key to enter the change and return to the **Home** screen.

Note: *If a particular watering zone appears over-or under-watered, adjust the station run time in the controller watering program. It is considered best practice to make adjustments in small increments; allowing several days between changes to observe the results.*

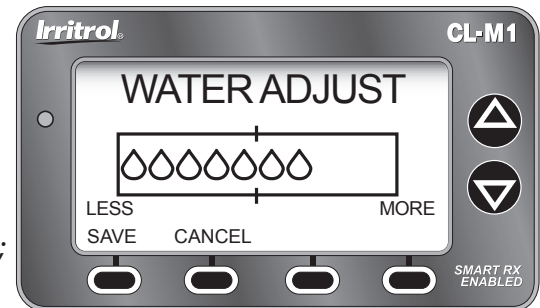

Rain/Freeze Sensor Control Feature

When rain or a low temperature condition is detected, system operation is placed on hold. The **Sun** icon is replaced with the corresponding **Rain Cloud** or **Snow Flakes** icon. The LED status indicator is on continuously while the system is on **Hold**.

When weather conditions improve, the Climate Logic system automatically resets for normal operation. An adjustable Dry-out period will prevent automatic watering for 12 hours (by default) before scheduled watering can resume. The Dry-out mode is adjustable from 0 to 3 days, in ½-day increments. To adjust the Dry-out time period, refer to the **Dry-out Days** setup procedure on page 14.

Note: To resume watering operation immediately after the reset, press the **BYPASS** key to skip the Dry-out mode.

Smart Bypass Mode: While the system is on hold, sensor control can be toggled **Off** and **On** by pressing the **BYPASS** key. The **Bypass** mode will be indicated on the **Home** screen, and the LED indicator will blink continuously. Watering operations can resume, however the Climate Logic system will remain in the **Bypass** mode until the system automatically resets after the **Dry-out** duration times out.

Note: To resume sensor control mode, press the **BYPASS** key again to toggle the Bypass mode Off.

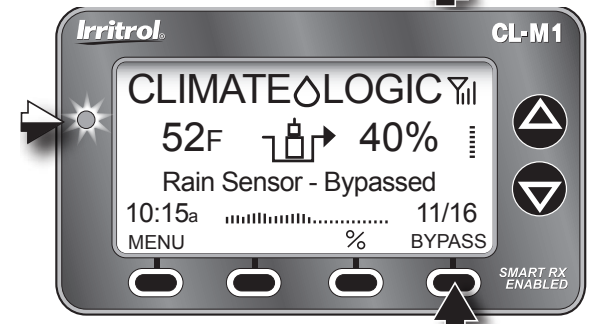
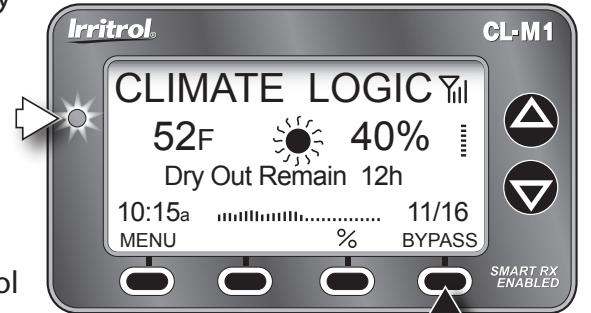
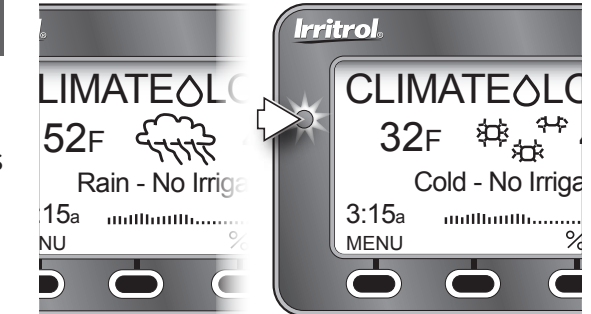

Water History Review Feature

The Climate Logic system tracks and records the daily adjustment factor for a rolling, two-year period. A one-month snapshot is represented by the small bar graph on the **Home** screen. The graph is updated daily, and builds from the left to right, with the most recent day appearing on the left of the scale.

Pressing the **%** key displays the **Water History** graph in a large-scale format. By default, the graph represents the daily adjustment history for a one-month period. Pressing the **ZOOM** key displays the history data in time frames of approximately 2-months, 6-months, 1-year, and 2-years.

Watering history data can also be reviewed in a contextual format, accessible through the **History** option of the **Utility Menu**. (**MENU** ⇒ **UTILITY** ⇒ **HISTORY**).

The **History** screen lists the date and adjustment % value for each day in chronological order, with the most recent entry at the bottom. Use the **NEXT** and **BACK** keys to scroll through the data screens.

Note: Data displayed in the **LOGFILE** screen is provided for service use only.

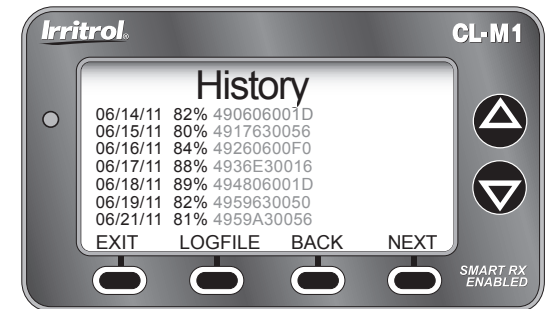
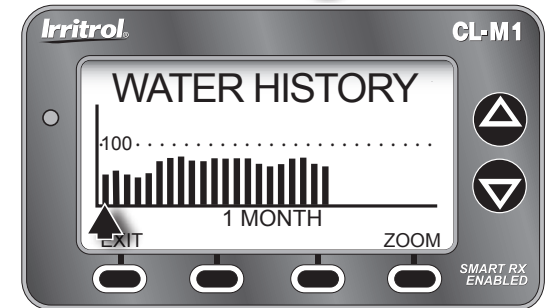
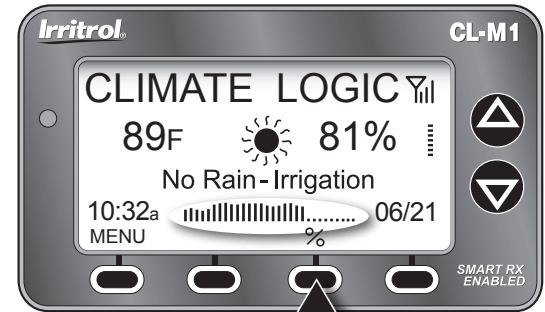

Weather Sensor Identification Feature

Within the **Sensor Setup** screen, the Weather Sensor ID can be easily viewed, and pairing removed/replaced as needed.

- From the **Home** screen, select the **Main Menu Sensor** option (MENU⇒SENSOR⇒ENTER). The ID number of the currently paired Weather Sensor will be displayed.
- To remove and replace the currently-paired Weather Sensor, press the **REMOVE** key to display the **Remove Sensor** screen.
- ⚠ **Important:** A new Weather Sensor must be activated before it can be paired with the Receiver Module. See page 9 for details.
- Press the **YES** key the display **Sensor Setup/Add Sensor** screen.
- Press the **ADD** key to initiate the sensor ID search function.
- Press and release the Weather Sensor **Test Pin** to “Ping” the Receiver Module. When pairing is successful, the 7-digit sensor ID is displayed.

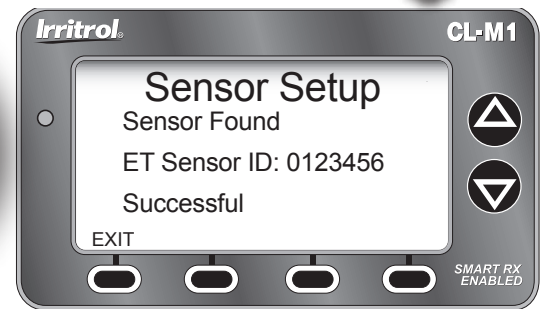
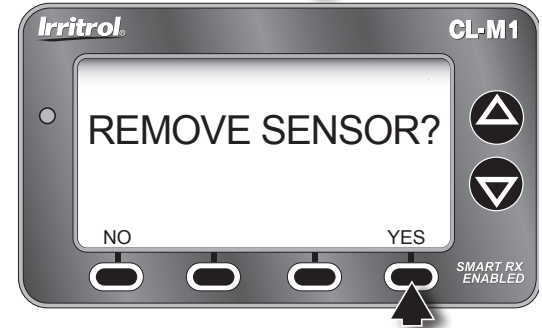
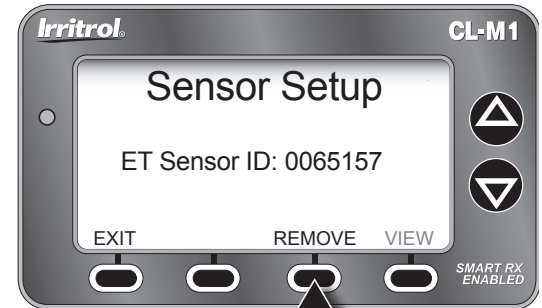
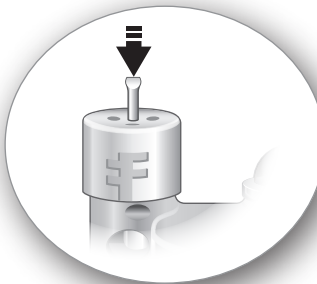
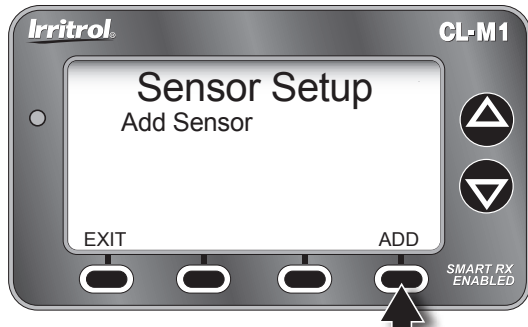

Control System Synchronization

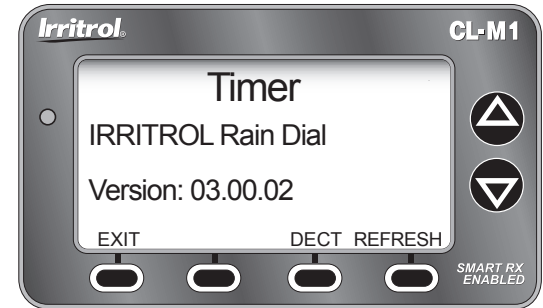

The Receiver Module and irrigation controller must remain synchronized for proper operation of Climate Logic system operations. The **Timer** option of the **Main Menu** provides the utility features that enable synchronization to be easily verified and updated as needed.

- From the **Home** screen, select the **Main Menu, Timer** option (**MENU**⇒**TIMER**⇒**ENTER**). The controller make, model and software version will be displayed.
- Press the **REFRESH** key as needed to update the controller information.
- Press the **DECT** (Detect) key to access the current controller time and date setting.



Remote PIN Setup

The irrigation controller can be accessed through the Receiver Module by a CL-R1 handheld remote device using the default 0000 PIN code. A unique PIN code can be applied to the Receiver Module to provide discrete remote control access as preferred.

- From the **Home** screen, select the **Main Menu, Sensor** option (**MENU**⇒**SENSOR**⇒**ENTER**).
- Press the  or  key to adjust the selected value.
- Press the **NEXT** key to select the next value in sequence.
- When the PIN is displayed correctly, press the **SAVE** key.

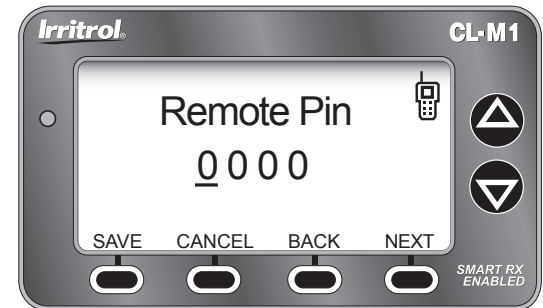

Weather Sensor Battery Replacement

In normal operating conditions, the Weather Sensor's single, 9V-Alkaline battery can provide service up to five years. A loss of signal will result from a weak battery condition. Replace the battery as follows:

- The battery is stored in the upper half of the sensor housing. To access the battery, release and remove the upper housing by twisting it clockwise while holding the base stationary.
- Disconnect the battery wire clip. Remove the used battery and insert a fresh 9V-Alkaline battery between the foam pad and housing. Reconnect the battery wire clip.
- To reassemble the sensor housing, dress the antenna wire through the lower housing, exiting the center hole in the bottom grid.
- Mate the halves squarely, aligning the translucent dome above the mounting bracket.
- Turn the upper housing counterclockwise to lock into lower housing (held stationary).

Note: Proper disposal of all batteries is very important for the environment and must comply with the battery manufacturer's recommended procedures.

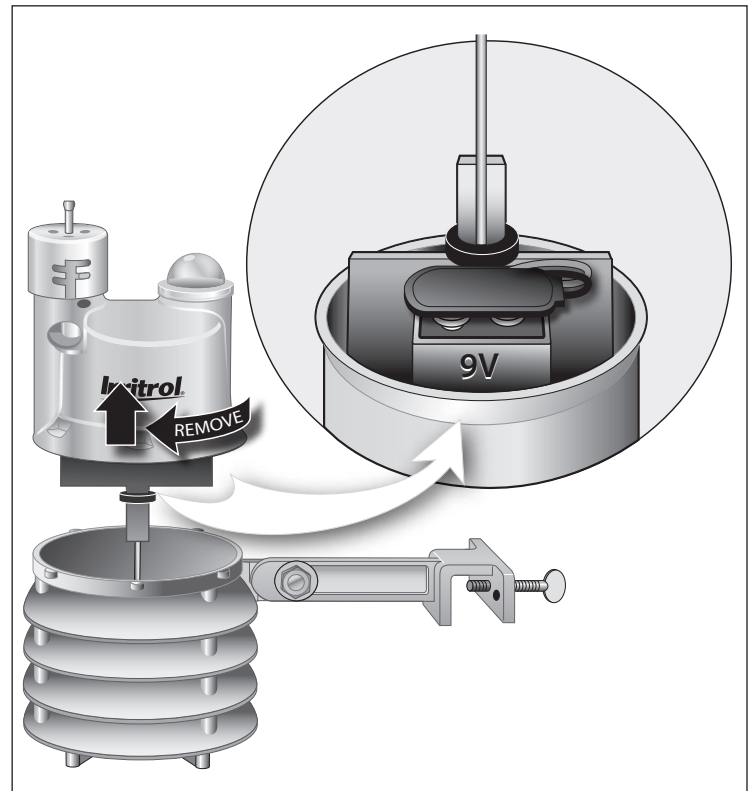

Specifications

Weather Sensor/Transmitter, Model CL-W1

- 2.75" W x 5" H x 6.25" D (over bracket)
7 cm W x 12.7 cm H x 15.9 cm D (over bracket)
- Battery: 9V-Alkaline, up to 5-year duration
- Antenna Wire:
1.5" L x 0.192 Dia.
3.81 cm L x 4.8 mm Dia.
- RF Reception Range: Up to 1000' (304 m) LOS
- Operating Temperature: 14–140 °F (-10°–60° C)
- Rain Sensing Method: Industry-standard, hygroscopic, stacked-disc style w/adjustable threshold
- Quick-Clip™ Mounting Bracket: Rain gutter/solid-surface mounting option w/vertical adjustment and stainless steel hardware.
- Visible RF Transmission LED
- UL, FCC and IC Approval
- FCC ID: OF7WS9
- IC: 3575A-WS9

Receiver Module, Model CL-M19

- Compatible with Remote-ready Irritrol and Toro Controllers and CL Series Handheld Remote
- Input Power (from controller): 5v DC
- LCD Screen Dimensions:
2.5" W x 1.25" H
6.35 cm W x 3.18 cm H
- LCD Contrast Adjustment
- Dimensions:
3.25" H (5.375" w/antenna) x 4.125" W x 0.75" D
8.26 cm H (13.16 cm w/antenna) x 10.48 cm W x 1.9 cm D
- Power/Data Cable:
20" L x 0.16 Dia.
50.8 cm L x 4.1 mm Dia.
RJ14 connector
- Indoor/Outdoor Installation
- Weather-resistant Enclosure (with cover closed)
- UL, FCC and IC Approval
- FCC ID: OF7CL9
- IC: 3575A-CL9

FCC Information

This equipment generates and uses radio frequency energy and if not installed and used properly, that is, in strict accordance with the manufacturer's instructions, may cause interference to radio and television reception. It has been type tested and found to comply with the limits for a FCC Class B computing device in accordance with the specifications in Subpart J of Part 15 of FCC Rules, which are designed to provide reasonable protection against such interference in a residential installation. However, there is no guarantee that interference will not occur in a particular installation. If this equipment does cause interference to radio or television reception, which can be determined by turning the equipment off and on, the user is encouraged to try to correct the interference by one or more of the following measures:

- Reorient the receiving antenna
- Relocate the irrigation controller with respect to the receiver
- Move the irrigation controller away from the receiver
- Plug the irrigation controller into a different outlet so that the irrigation controller and receiver are on different branch circuits.

If necessary, the user should consult the dealer or an experienced radio/television technician for additional suggestions. The user may find the following booklet prepared by the Federal Communications Commission helpful: "How to Identify and Resolve Radio-TV Interference Problems." This booklet is available from the U.S. Government Printing Office, Washington, DC 20402. Stock No. 004-000-00345-4.

Notes

Notes:



At Irritrol, we recognize the importance of effective water management in the irrigation industry, and have been working hard to produce products that promote the responsible use of water. The Water Saver® symbol accompanies each of our products that provide a significant water-savings opportunity. As you can see, the Climate Logic system proudly bears this distinctive symbol.