



T415.502 Bath/Shower Trim Shown

GENERAL DESCRIPTION:

TRIM KIT

FloWise water saving 3-function showerhead offers up to 40% water savings at maximum 2.0gpm/7.6L/min. flow rate. Metal slip-on diverter spout. Available with metal lever handle.

ROUGH VALVE BODY

Cast brass body, washerless 47mm ceramic disc valve cartridge with volume and temperature control, and hot limit safety stop. Pressure balancing cartridge maintains constant output temperature in response to changes in relative hot and cold supply pressure. One-half inch inlets and outlets (choice of direct sweat, threaded, or PEX). Available with screwdriver stops. Rough-in plaster guard designed for use as thin-wall mounting adaptor. Valve body will accept a variety of decorative Bath/Shower trim kits.

Valve body will accept a variety of decorative Bath/Shower Trims

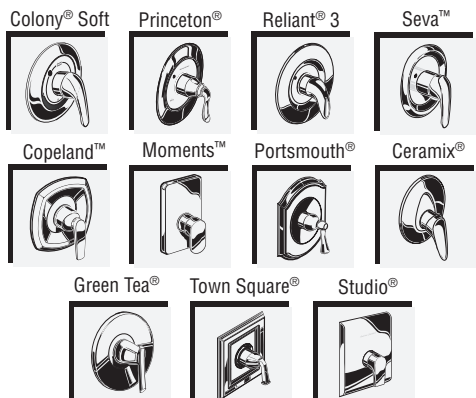

SUGGESTED SPECIFICATION:

Bath/shower fitting shall feature water saving 3-function showerhead with Max. 2.0gpm/7.6L/min. flow rate. Shall feature a cast brass valve body. Shall feature ceramic disc valve cartridge which allows user to control both water temperature and volume. Fitting shall be equipped with pressure balancing cartridge engineered to eliminate cross flow and avoid failure due to mineral deposits. Shall also feature a hot limit safety stop. Fitting shall be: Rough Valve Body - American Standard Model # R12____, Trim Kit - American Standard Model # T415.50____.

MODEL NUMBER:

TRIM KITS:

- ☐ T415.502 Portsmouth BATH/SHOWER Trim Kit
Metal Lever Handle. FloWise Showerhead. L ESS Valve Body.
- ☐ T415.501 Portsmouth SHOWER ONLY Trim Kit
Metal Lever Handle. FloWise Showerhead. L ESS Valve Body.
- ☐ T415.500 Portsmouth VALVE ONLY Trim Kit
Metal Lever Handle. LESS Valve Body.

ROUGH VALVES:

- ☐ R120 Pressure Balance Rough Valve Body only
Direct sweat inlets/outlets. LESS trim.
- ☐ R120SS Pressure Balance Rough Valve Body only with Screwdriver stops
Direct sweat inlets/outlets. Screwdriver stops. LESS trim.
- ☐ R125 Pressure Balance Rough Valve Body only
Female thread inlets/outlets. LESS trim.
- ☐ R125SS Pressure Balance Rough Valve Body only with Screwdriver stops
Female thread inlets/outlets. Screwdriver stops. LESS trim.
- ☐ R127 Pressure Balance Rough Valve Body only
PEX inlets/Direct sweat outlets. LESS trim.
- ☐ R127SS Pressure Balance Rough Valve Body only with Screwdriver stops
PEX inlets/Direct sweat outlets. Screwdriver stops. LESS trim.

PRODUCT FEATURES:

Flowise Water Saving 3-Function Showerhead: Saves up to 40% in water usage. Max. 2.0gpm/7.6L/min. flow rate.

Cast Brass Valve Body: Durable - Quality that will last a lifetime. Ideal material for prolonged contact with water.

Ceramic Disc Valve Cartridge: Assures a lifetime of drip-free performance. Allows easy control over both water temperature and volume.

Pressure Balancing Valve Cartridge: Maintains constant output temperature in response to changes in relative hot and cold supply pressure. Diaphragm system engineered to eliminate cross flow. Avoids failure due to mineral deposits - ideal for use in hard water.

Back-to-Back Capability: Hot and cold can be reversed quickly and easily.

Adjustable Hot Limit Safety Stop: Limits the amount of hot water allowed to mix with cold. Reduces the risk of accidental scalding.

Exclusive Plaster Guard: Plaster guard is designed to protect valve during installation and serve as a mounting plate for thin-wall installations. Two piece design allows valve to be tested prior to trim installation.

Wide Rough-in Range: From 1-5/8" to 3-1/4".

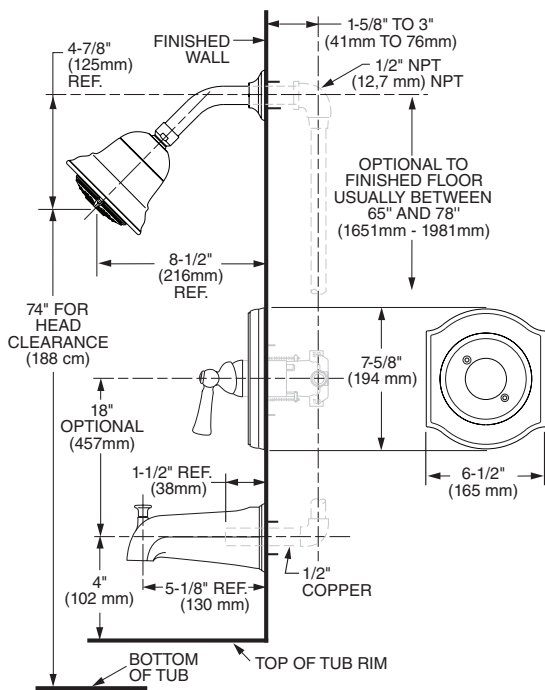

VALVE BODY OPTIONS

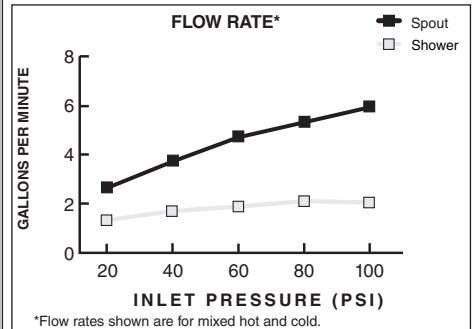
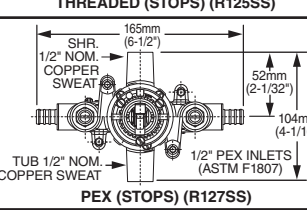
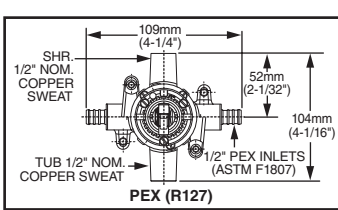
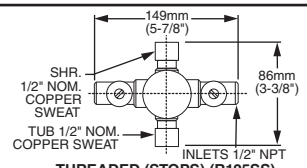
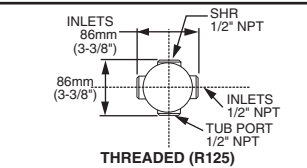
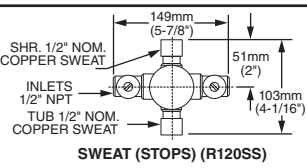
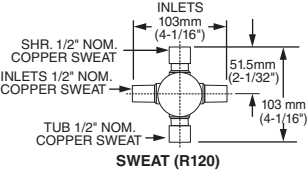

CODES AND STANDARDS

These products meet or exceed the following codes and standards:
ANSI A 117.1
ASSE 1016
ASME A112.18.1
CSA B 125

Meets the American Disabilities Act Guidelines and **ANSI A117.1** Requirements for the physically challenged.

TRIM KITS *	Product Number	Description	Finish Options		
			Polished Chrome	Oil Rubbed Bronze	PVD Satin Nickel
			002	224	295
T415.502	Bath/Shower Trim Kit. Metal Lever Handle. FloWise Showerhead. LESS Valve Body.				
T415.501	Shower Only Trim Kit. Metal Lever Handle. FloWise Showerhead. LESS Valve Body.				
T415.500	Valve Only Trim Kit. Metal Lever Handle. LESS Valve Body.				

ROUGH VALVE BODIES	Product Number	Description
R120	Rough Valve Body less trim. Direct Sweat inlets/outlets.	
R120SS	Rough Valve Body less trim. Direct Sweat inlets/outlets with Screwdriver Stops.	
R125	Rough Valve Body less trim. Female Thread inlets/outlets.	
R125SS	Rough Valve Body less trim. Female Thread inlets/outlets with Screwdriver Stops.	
R127	Rough Valve Body less trim. PEX inlets/ Direct Sweat outlets.	
R127SS	Rough Valve Body less trim. PEX inlets/ Direct Sweat outlets with Screwdriver Stops.	

* TRIM & ROUGH MUST BE ORDERED SEPARATELY.