

## S8700B,D-F,J-M Direct Spark Ignition Controls

### INSTALLATION INSTRUCTIONS

#### APPLICATION

S8700 Direct Spark Ignition Controls are designed for use in a wide range of gas-fired appliance applications that require direct main burner ignition and flame safety control of gas burners. The S8700 is used to ignite the main burner, sense the flame and control the gas valve. See Table 1 for the model that best meets your application needs.

The S8700B,E,J,L models provide single rod flame sensing (i.e., the spark rod also acts as the flame sense rod). The S8700D,F,K,M models provide dual rod flame sensing (i.e., the spark rod and flame rod are separate). The S8700J,K,L,M models provide 30-second minimum time delay between application of 24V power to the control and initiation of the trial for ignition period for applications that require prepurge. All models have an LED status indicator.

Table 1. S8700 Models.

Model	Flame Sense	Trials for Ignition	Prepurge (seconds)
S8700B	1-rod local	1	0
S8700D	2-rod remote	1	0
S8700E	1-rod local	3	0
S8700F	2-rod remote	3	0
S8700J	1-rod local	1	30 minimum
S8700K	2-rod remote	1	30 minimum
S8700L	1-rod local	3	30 minimum
S8700M	2-rod remote	3	30 minimum

#### SPECIFICATIONS

##### Electrical

Input Voltage: 24 Vac (20.5 Vac minimum to 28.5 Vac maximum) at 60 Hz.

Current Draw: 0.15A maximum in run mode at 24 Vac. Thermostat Anticipator Setting: 0.15A plus actual valve load.

Valve Output: 2.0A maximum run; 6.0A maximum inrush at 24 Vac.

Alarm Output: 0.5A maximum resistive load (Output is positive phase, one-half wave rectified, 24 Vac).

Spark Output: 14 KV minimum into 25 picofarad capacitive load.

##### Environmental

Ambient Operating Temperature: -40°F to +175°F (-40°C to +79°C).

Relative Humidity: 5% to 95% at 95°F (35°C), noncondensing.

##### Ignition Sequence/Flame Sense

Prepurge: See Table 1.

Ignition Trials to Lockout: See Table 1.

Trial for Ignition Times: 4.6, 6.6, 11.1 or 21.1 second nominal available.

Between Trial Purge: 30 second minimum (S8700E,F,L,M only).

Auto Reset from Lockout: 60 minutes minimum (S8700E,F,L,M only).

Flame Failure Re-ignition Time: 0.8 second maximum at 1 microamp flame current.

Flame Current:

Minimum Threshold: 1 microamp.

Appliance Application: 2.5 microamp minimum recommended under all appliance operating conditions.

##### Approvals:

CSA International Design Certified to ANSI Z21.20, Report Number C2030026.

#### PLANNING THE INSTALLATION

### WARNING

**Fire or Explosion Hazard.**

**Gas leaks can cause property damage, severe injury or death.**

Follow these warnings exactly:

Plan the installation using the following outline. Plan for frequent maintenance as described in the Maintenance section.

Review the following conditions that apply to your specific installation and take the precautionary steps suggested.



## Frequent Cycling

The S8700 is designed to cycle three to four times each hour during the heating season. Year-round applications and applications with more frequent cycling rates can wear out the controls more quickly than normal operation. Perform monthly system checks to make sure the system operates properly.

## Water or Steam Cleaning

If a control gets wet, replace it. If the appliance is likely to be cleaned with water or steam, cover the control and wiring to protect them from water or steam flow. Mount the control high enough above the floor so it does not get wet during normal cleaning procedures.

## High Humidity or Dripping Water

Dripping water can cause the control to fail. Never install an appliance where water can drip on the control. In addition, high ambient humidity can cause the control to corrode and fail. If the appliance is in a humid atmosphere, make sure air circulation around the control is adequate to prevent condensation. Also, regularly check out the system.

### IMPORTANT

*Always install a splash cover to protect the control from water damage.*

## Corrosive Chemicals

Corrosive chemicals can attack the control, eventually causing a failure. If chemicals are used for routine cleaning, avoid contact with the control. Where chemicals are suspended in air, as in some industrial or agricultural applications, protect the control with an enclosure.

## Dust or Grease Accumulation

Heavy accumulations of dust or grease can cause the control to malfunction. Where dust or grease can be a problem, provide covers for the control to limit contamination.

## Heat

Excessively high temperatures can damage the control. Make sure the maximum ambient temperature at the control does not exceed the rating of the control, see Specifications section. If the appliance operates at very high temperatures, use insulation, shielding and air circulation, as necessary, to protect the control. Proper insulation or shielding should be provided by the appliance manufacturer; verify proper air circulation is maintained when the appliance is installed.

## System Requirements

S8700 system requirements:

- Q347A Spark Igniter and Q354A Flame Sensor, or a Q366 with separate spark igniter and flame sensor mounted on a common bracket. (Equivalent ignition hardware may be used.)
- Honeywell VR8205 Gas Valve (or equivalent) designed for DSI applications. Valve loads must be within the range listed in the Specifications section.

## INSTALLATION

### When Installing this Product...

1. Read these instructions carefully. Failure to follow them could damage the product or cause a hazardous condition.
2. Check the ratings given in the instructions and on the product to make sure it is suitable for your application.
3. The installer must be a trained, experienced service technician.
4. After installation is complete, check out system operation.

## WARNING

### Fire or Explosion Hazard.

**Gas leaks can cause property damage, severe injury or death**

Always turn off gas supply before installing a new gas control.

Be sure to conduct a gas leak test after installing the control.



## CAUTION

### Electric Shock Hazard.

**Power supply can cause personal injury or equipment damage.**

Disconnect power supply before installation.

### IMPORTANT

*If this is a replacement application, follow the appliance manufacturer's instructions, if available.*

*The manufacturer usually provides wiring diagrams, start-up and checkout instructions and service procedures for their system. If the manufacturer's instructions are not available, use these instructions as a general guide.*

## MOUNTING

### S8700 Control

Select a location within 6 ft (1.8m) of the burner that permits a direct cable route to the spark igniter terminal. Ready access to the S8700 terminals is necessary for wiring and servicing. Do not exceed the ambient temperature rating given in the Specifications section.

To mount the S8700:

1. Mount the S8700 in any position. See Fig. 1 for mounting dimensions.
2. Use No. 6-32 machine screws or 1 in. No. 8 sheet metal screws for fastening.
3. Fasten the screws securely.

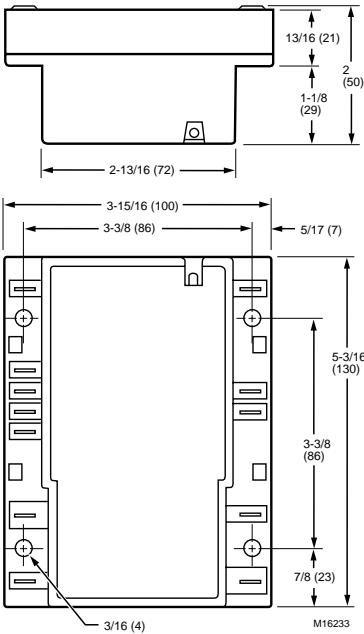

Fig. 1. S8700 mounting dimensions in in. (mm).

### Auxiliary Controls

Mount the spark igniter, flame sensor, temperature control, transformer, gas control and any other auxiliary controls according to the manufacturer's instructions.

NOTE: Make sure the 24V system transformer is rated to handle both the S8700 current and the total gas valve current.

### WIRING

#### General Precautions

- For circuits that differ from the diagrams in Fig. 2 and 3, check the wiring diagrams from the heating appliance manufacturer, if available. Carefully follow any special instructions that would affect the following general procedures.
- All wiring must comply with applicable electrical codes and ordinances.
- Disconnect the power supply before wiring to prevent electrical shock or equipment damage.
- When installing a separate flame sensor, the sensor leadwire should be kept as short as possible and should not be allowed to rest against grounded metal surfaces.
- Ignition cable should not touch any metal surface or current carrying wires. It must not be more than 6 ft (1.8m) long. See Table 2 for recommended ignition cable.
- Do not short valve terminals as this can damage the temperature controller, the transformer or the S8700 control.

Table 2. Recommended Ignition Cable.

Cable Type	RMS Voltage Rating	Maximum Ambient Temperature Rating	
		F	C
UL Style 3257	10,000	482	250

### Wiring the S8700 Control

- Connect the system components to the S8700 terminals as shown in the wiring diagrams, Fig. 2 and 3. Refer to the heating appliance manufacturer's instructions for wiring any other auxiliary controls.
- Adjust the temperature control heat anticipator (if provided) to match the system current draw. The current draw equals the total current required for the S8700 (0.15A) plus the gas valve and all other 24V control loads (vent dampers, and prepurge relays). Gas valve must be designed for the DSI application.

NOTE: Use only recommended ignition cable (see Table 2), or equivalent, to connect the S8700 with the spark igniter. Cable must not run in continuous contact with a metal surface or spark voltage is greatly reduced; use ceramic standoff brackets if necessary. Cable length must not exceed 6 ft (1.8m).

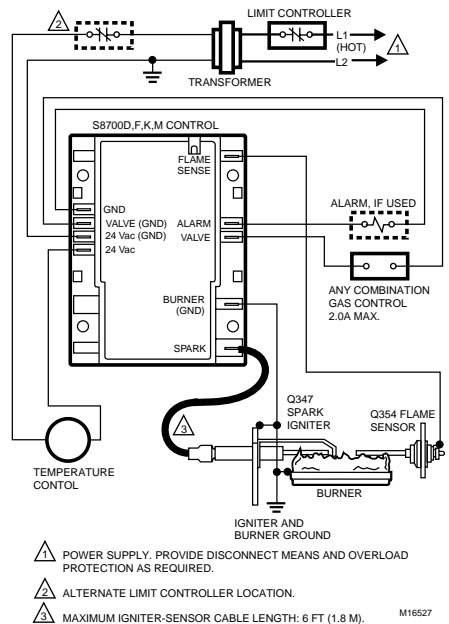
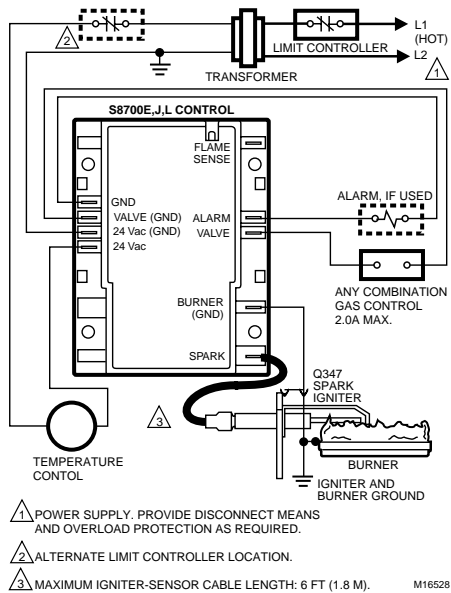

Fig. 2. Typical wiring diagram for S8700D,F,K,M dual rod models.



**Fig. 3. Typical wiring diagram for S8700E,J,L single rod models.**

**NOTE:** Proper system operation requires that the S8700 GND (Burner) terminal is wired to be electrically common with the spark electrode bracket, flame sensor bracket (if a separate flame sensor is used) and the main burner. In many applications, this is accomplished through connecting the S8700 GND (Burner) terminal to the appliance chassis, as the other noted components are presumed to be electrically common with the appliance chassis. If flame sensing problems are noted, it may be due to corroded or loose electrical connections between the noted components and the appliance chassis.

## STARTUP

The following start-up procedures are basic to all S8700 controls. If this is a replacement application, refer to the specific instructions provided by the heating appliance manufacturer, if available. Also, since the auxiliary controls used on any DSI system can differ, refer to the manufacturer's instructions for start-up and checkout procedures for other system components.

**NOTE:** If the S8700 does not perform as outlined in the following Start System and Check Trial for Ignition steps, refer to the Service section to determine the cause.

## Gas Leak Test

If the gas control has been replaced as a part of the S8700 installation, perform the following test for gas leaks.

## ⚠️ WARNING

### Explosion or Fire Hazard.

**Gas Leaks can cause property damage, severe injury or death.**

To avoid possible explosion or fire, perform the Gas Leak Test.

With the main burner in operation, paint the pipe joints and valve gasket with a rich soap and water solution. Bubbles indicate a gas leak. To stop a leak, tighten the joints and screws. Never use a flame to check for gas leaks.

## Start System

1. Turn on the power and the gas supply.
2. Set the temperature control to call for heat and watch for a spark at the igniter (S8700B,D,E,F models have no delay on start-up; S8700J,K,L,M models have a predetermined delay on start-up for prepurge). Check that the system starts as follows: Prepurge delay (if provided), spark turns on, gas valve opens at once and burner ignites after gas reaches the main burner. Once the burner flame is established, spark igniter cuts off.

**NOTE:** NOTE: If the gas control has been replaced or serviced, lightoff may not be satisfactory until air has been purged from the gas line or the gas input and combustion air have been adjusted (see manufacturer's instructions).

**Table 3. S8700 Trial for Ignition Periods.**

Specified Trial for Ignition (TFI) (stamped on control)	Trial for Ignition Should Not Exceed
4.6 sec	5.0 sec
6.6 sec	7.0 sec
11.1 sec	11.5 sec
21.1 sec	21.5 sec

## Check Trial for Ignition

1. Check device label on the control to determine the correct trial for ignition time.
2. With the system power off and the thermostat or temperature control set to call for heat, manually shut off the gas supply.
3. Turn power on to energize the S8700 and immediately start timing when the gas valve is energized.
4. Determine the number of seconds to drop-out of the gas valve. It should not exceed the trial for ignition time shown in Table 5.
5. After spark cutoff, manually reopen the gas supply cock. No gas should flow to the main burner. Reset the system as described in Resetting S8700 After Safety Lockout section.
- 6.

## Resetting S8700 After Safety Lockout

After completing the normal ignition sequence, without proving main flame, the S8700 models will shut off the spark and gas flow and go into lockout. S8700B,D,J,K will stay in lockout until the call for heat is removed and restored. S8700E,F,L,M will stay in lockout for 60 minutes, then another ignition sequence will start. If the call for heat is interrupted then restored, all S8700 models will start a new ignition sequence.

To reset the system at any time:

Adjust the temperature control setting to below the room temperature, wait five seconds, and move the temperature control setting up to call for heat or remove 24V power and reapply. Normal ignition should occur as described in the Start System section.

## CHECKOUT

Start the system and observe operation through at least two complete cycles to make certain all controls and the appliance are operating safely.

## Sequence of Operation

The S8700 control performs the following basic functions:

- Supplies power to the electronic pulse-generator circuit for the spark igniter. Allows up to the specified trial for ignition and one or three trials before system safety lockout occurs (see Table 1 and Table 3).
- Senses the burner flame(s) for safe lighting.
- Shuts off spark after burner is lit.

The S8700 is powered by a 24V transformer and is activated when the temperature control calls for heat. See Fig. 4 or 5, depending on model.

Operation is as follows:

When the S8700 is activated by the call for heat from the temperature control, the S8700 performs a safe-start check that determines proper operation of the control before beginning the normal sequence of operation. This check also determines if a flame signal is being sensed. If flame is sensed or the control identifies any internal failure, the S8700 will go to lockout (LED steady on). Once the safe start check operation passes, the S8700 turns on the spark circuit and at the same time energizes the gas control main valves and allows gas to flow to the main burner.

Sparking continues until the trial for ignition ends, unless the main burner lights and is sensed as sufficient to shut off the spark and allow normal operation.

If the main burner lights, a flame sensing circuit is completed through the flame to the burner head and back to the S8700 GND (Burner) terminal. This current flow sets the trial for ignition timer to the reset (normal) condition and interrupts the spark ignition circuit. Should the current flow be interrupted, i.e., flame out condition, the spark will be re-initiated immediately and a normal trial for ignition will occur. If the main burner lights and proves, a normal run will occur. If the main burner does not light and prove, the S8700 goes into lockout.

The S8700 keeps the gas control main valve open as long as there is a call for heat and sufficient flame current through the flame sensing circuit. If, however, the trial for ignition period ends before the main burner lights or the main flame generates enough flame current, the system goes into safety lockout (S8700B,D,J,K) or between trial purge (S8700E,F,L or M).

When the system goes into safety lockout, power to the spark generator is interrupted, the power to the gas valve is interrupted, the alarm circuit is completed and the LED is steady on. The system stays locked out until it is reset by moving the temperature control setpoint to below the room temperature, no call for heat, for five seconds. The system can be re-energized by moving the temperature control setpoint 5°F (3°C) above the room temperature or removing 24V power to the control then reapplying.

Note: S8700E,F,L,M models automatically reset from lockout after one hour if the call for heat is still present. A normal ignition sequence will be initiated.

## SERVICE



### WARNING

**High Voltage Hazard.**

**Shock can cause personal injury.**

To prevent electric shock, do not allow fingers to touch the stripped end of the jumper or the spark terminal.

### IMPORTANT

- Only persons trained and experienced in DSI systems should service this equipment.
- Always de-energize the system for at least five seconds before recycling for further tests.
- Always turn off the gas supply before performing ignition checks.
- S8700 control cannot be repaired. If the troubleshooting procedure indicates a malfunction in the S8700, it must be replaced.
- The following service procedures are for the S8700 and basic DSI systems. On all installations, refer to the appliance manufacturer's service instructions.

## Preliminary Check

The following checks should be made before troubleshooting the system:

- Check for power to the heating appliance and the S8700. Voltage to the control should be between 20.5 and 28.5 Vac, when in run mode.
- Make certain that the manual shut-off valve in the supply line and the gas cock knob on the combination gas control valve are open.
- Check the ignition cable for signs of damage or cut insulation, exposed wires or loose connections. Repair or replace as necessary.
- Make certain that all wiring connections are clean and tight.

## S8700 COMPONENT CHECKS

### Spark Ignition Circuit

The S8700 provides high voltage spark energy to light the main burner. To check the spark ignition circuit, do the following:

1. Shut off the gas supply to the gas control.
2. Be sure system power supply delivers proper voltage to the S8700 during the ignition cycle.
3. Disconnect the ignition cable at the S8700 spark terminals to isolate the circuit from the spark igniter or igniter sensor. Prepare a short jumper lead, using heavily insulated wire such as ignition cable.

- Make certain that the S8700 is not in safety lockout. De-energize the system by moving the temperature control setpoint below the room temperature or remove power to the S8700 control. Wait at least five seconds and reenergize the system by moving the temperature control setpoint 5°F (3°C) above the room temperature. Reapply 24 Vac power to the S8700 control.
- Check the ceramic insulator on the flame sensor, spark igniter or igniter/sensor. A cracked insulator allows current to leak to ground. Replace the device if the insulator is cracked.
- Check the flame sensor and its mounting bracket. Flame sensor must be held firmly in place and be positioned in the most flame per the appliance manufacturer specifications. Repair or replace as necessary. Correct the position if it is bent out of shape.
- Review the S8700 normal sequence of operation. See the Start System section.

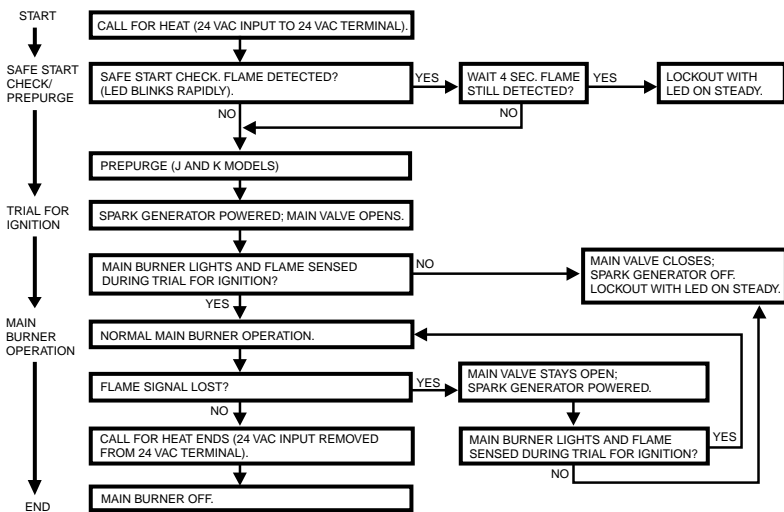

NOTES:  
 — WHEN CONTROL IS IN LOCKOUT, ALARM OUTPUT (IF PROVIDED) IS ENERGIZED.  
 — LED FLASHES AT HEARTBEAT SPEED DURING ALL NORMAL OPERATION.

M16529

Fig. 4. S8700B,D,J,K one-trial sequence of operation.

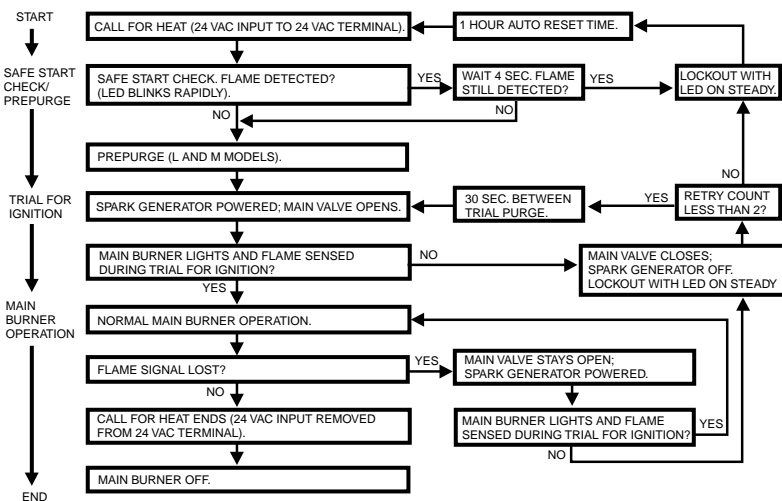

NOTES:  
 — WHEN CONTROL IS IN LOCKOUT, ALARM OUTPUT (IF PROVIDED) IS ENERGIZED.  
 — LED FLASHES AT HEARTBEAT SPEED DURING ALL NORMAL OPERATION.

M16530

Fig. 5. S8700E,F,L,M retry sequence of operation.

## ⚠ WARNING

### High Voltage Hazard. Shock can cause personal injury.

To prevent electric shock, do not allow fingers to touch the stripped end of the jumper or the spark terminal.

- Perform this test immediately upon energizing the system, before the S8700 goes into lockout and interrupts the spark circuit. Touch one end of the jumper firmly to the S8700 GND terminal. *Do not* remove the existing ground lead. Slowly move the other end of the jumper wire toward the spark terminal on the control to establish a spark. Pull the wire away from the spark terminal and note the length of the gap at which the spark discontinues.
- A spark length of 1/8 in. (3 mm) or more indicates satisfactory voltage output. If no arc can be established or the maximum spark is less than 1/8 in. (3 mm) and power to the S8700 input terminals was proved, replace the S8700.

## Ignition Cable

Check the electrical continuity of the ignition cable and make certain that the cable is not in contact with metal surfaces. The total cable length should not exceed 6 ft (1.8m). Check connection to the spark terminal on the S8700 and the boot connection to the igniter/sensor. Make certain they are clean and tight.

## Grounding Connections

A common ground is required for the main burner, spark igniter mounting bracket or igniter sensor mounting bracket, and the GND (burner) terminal of the S8700. If the common ground connections are poor or erratic, safety shutdown can occur occasionally even though operation is normal at time of checkout. Therefore, if nuisance shutdowns have been reported, be sure to check ground connections.

Electrical ground connections at the spark igniter or igniter sensor and the S8700 must be clean and tight. If leadwire is damaged or deteriorated, use only a No. 14 or No. 18 gauge, moisture resistant, thermoplastic insulated wire with 221°F (105°C) minimum rating as a replacement.

## Flame Sensor Circuit

The S8700 provides ac voltage to the flame sensor. When a flame of sufficient size is present, the ac voltage is rectified and sensed as a dc flame current by the S8700. The S8700 will operate with a steady 1.0  $\mu$ A dc flame current. However, reliable appliance operation requires at least 2.0  $\mu$ A flame current (measured with an analog dc microammeter during worst case appliance checkout.).

Check the flame sensing current from the sensor to the S8700 as follows:

For S8700D,F,K,M:

1. Connect an analog meter (dc microammeter scale) in series with the flame sense lead as shown in Fig. 6. Use the Honeywell W136A test meter or equivalent. Disconnect the flame sense wire from the sense terminal on the control. Connect the red (positive) meter lead to the flame sense terminal on the control. Connect the black (negative) meter lead to the flame sense wire leading to the flame rod.
2. Restart the system and read the meter. The flame sense current should be at least 2.0  $\mu\text{A}$  and steady to assure reliable appliance operation. If the reading is less than 2.0  $\mu\text{A}$  or unsteady, See the Low Or Unsteady Flame Current section. If flame is present at the sensor and a reading of 0  $\mu\text{A}$  is obtained, check for damaged insulation or ground path in the flame sensor wiring. Also check for damaged, wet or dirty ceramic in the flame sensor assembly.

For the S8700B,E,J,L:

1. Connect a switch between the S8700 spark terminal and the spark cable. See fig. 7.
2. Attach meter leads on each side of the switch.
3. Light burner with the switch closed, then open the switch to read flame current.

**IMPORTANT**

*Do not let spark energy enter the meter or damage can result.*

**LOW OR UNSTEADY FLAME CURRENT**

If the current to the S8700 is less than 2.0  $\mu\text{A}$  or is unsteady, check the burner flame, flame sensor location and electrical connections as described in the following sections.

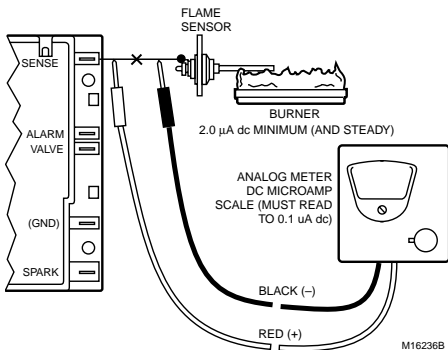

**Fig. 6. S8700D,F,K,M dual-rod flame current measurement.**

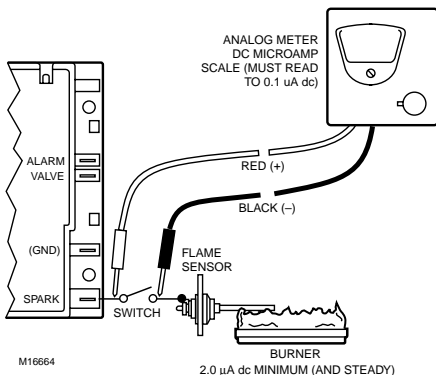

**Fig. 7. S8700B,E,J,L single rod flame current measurement.**

**Burner Flame**

The flame sensor must be constantly immersed in flame. Check the burner flame conditions as shown in Fig. 7.

**NOTE:** Note:If the main burner flame is fluctuating or lifting off the main burner, intermittent flame signals can be generated. Adjust the appliance so that the main flame is steady and not lifted from the main burner.

**Flame Sensor**

The flame signal is best when about 1 in. (25 mm) of flame rod is immersed in the burner flame. A bent flame rod, bent mounting bracket or cracked ceramic insulator can affect flame signal. A cracked ceramic insulator may perform properly when cold, but can cause intermittent operation when it heats up. Replace flame sensor if necessary.

**Electrical Connections and Shorts**

All wiring must be in good condition; replace if insulation shows any sign of damage. Connections at the S8700 and the flame sensor must be clean and tight. Wiring between the main burner and the S8700 (burner) terminal must also be in good condition. A jumper between the GND (burner) terminal and the main burner will often confirm if the flame circuit wiring needs attention. If wiring needs replacement, use moisture resistant No. 18 wire rated for continuous duty up to 221°F (105°C).



## CHECKOUT AFTER SERVICE

Perform the following steps before leaving the site (described in the Startup section).

- Start System
- Check Trial for Ignition
- Resetting S8700 After Safety Lockout

Also perform any other checks recommended by the heating appliance manufacturer if system components other than the S8700 were serviced.

### CHECK BURNER FLAME CONDITION

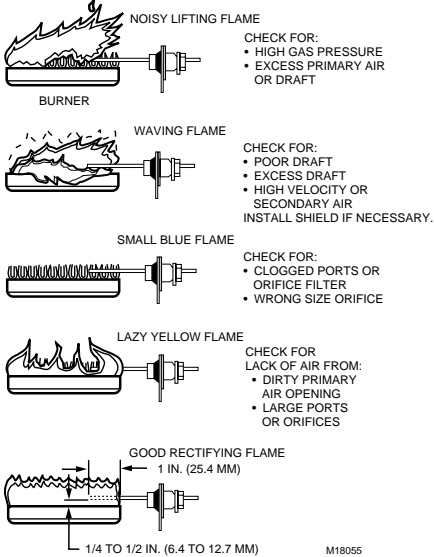
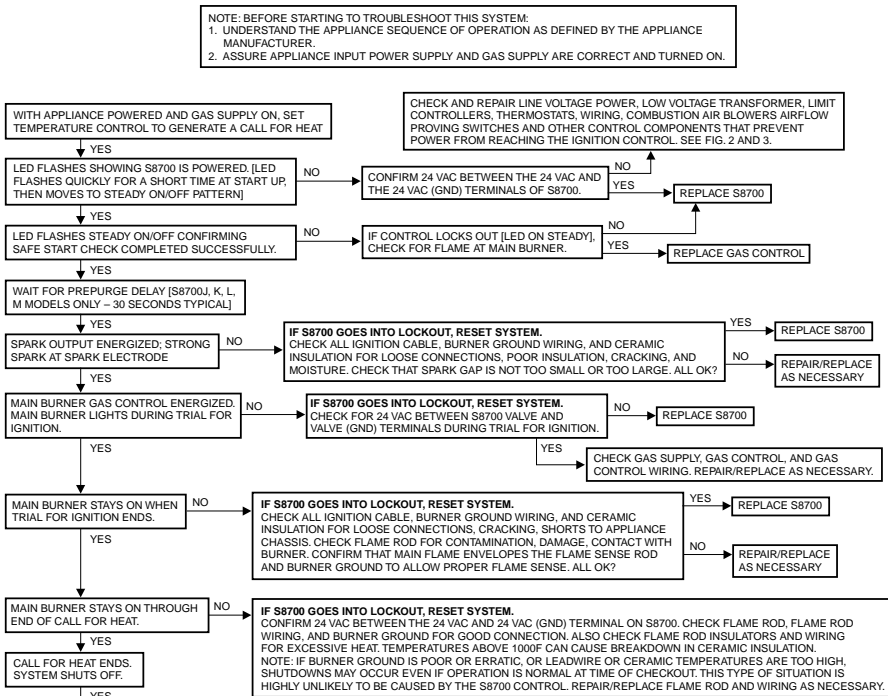

Fig. 8. Burner flame conditions.

## TROUBLESHOOTING GUIDE

Start the system by setting the thermostat or temperature control to call for heat. Observe the system response and establish the type of malfunction or deviation from normal operation by using the Troubleshooting Guide, see Fig. 9. After any maintenance or repair, the troubleshooting sequence should be repeated until normal system operation is obtained.

**NOTE:** When the appliance is in the lightoff mode, ignition spark and the gas control are energized only during the trial for ignition, which can last from four to 21 seconds, depending on the S8700 model. It will be necessary to recycle the call for heat to the control while performing this troubleshooting procedure.



**REPEAT PROCEDURE UNTIL TROUBLE-FREE OPERATION IS OBTAINED.**

**NOTES:**

- B, D, J AND K MODELS GO THROUGH ONE TRIAL FOR IGNITION PERIOD BEFORE LOCKOUT.
- E, F, L AND M MODELS GO THROUGH THREE TRIAL FOR IGNITION PERIODS (WITH A 30 SECOND INTERPURGE PERIOD BETWEEN EACH TRIAL FOR IGNITION ) BEFORE LOCKOUT CONTROL STARTS ANOTHER IGNITION SEQUENCE AUTOMATICALLY AFTER ONE HOUR.
- CONTROL IS IN LOCKOUT WHEN VALVE IS CLOSED, SPARK IS OFF, ALARM IS ACTIVATED AND LED IS ON STEADY. ON E, F, L, M MODELS, ONE HOUR AUTO RESET TIMER IS ALSO ACTIVATED.

M16663

**Fig. 9. S8700 Direct Spark Ignition system troubleshooting guide.**



**Honeywell**

---

**Home and Building Control**  
Honeywell Inc.  
Honeywell Plaza  
P.O. Box 524  
Minneapolis, MN 55408-0524

**Home and Building Control**  
Honeywell Limited-Honeywell Limitée  
155 Gordon Baker Road  
North York, Ontario  
M2H 3N7

