

VR8300/VR8301 Continuous Pilot Combination Gas Control

Application

These continuous pilot gas controls are used in gas-fired appliances with capacities up to 200 cu ft/hour at 1 in. wc pressure drop [5.7 cu m/hr at 0.25 kPa] on natural gas. They include a manual valve, safety shutoff, single automatic operators, and a pressure regulator. See Table 3 for temperature ranges and regulator types.

BODY PATTERN: Straight-through body pattern.
 INLET X OUTLET SIZES AVAILABLE: 1/2 x 1/2 in., 1/2 x 3/4 in., and 3/4 x 3/4 in. (factory-installed inlet flange).
 ADAPTERS: Adapters available for 1/2 and 3/4 inch straight and angle connections. Refer to Table 4.
 ELECTRICAL RATINGS:
 Voltage and Frequency: 24 Vac, 50/60 Hz.
 Current Draw: 0.70A.
 CAPACITY: See Table 1.

TABLE 1: CAPACITY OF VR8300/VR8301

| Size (Inlet x Outlet) | Capacity (at 1 in. wc pressure drop) ^a | Minimum Regulated Capacity | Maximum Regulated Capacity |
|-----------------------|---|------------------------------|-------------------------------|
| 1/2 x 1/2 | 180 cu ft/hr [5.1 cu m/hr] | 30 cu ft/hr [0.8 cu m/hr] | 225 cu ft/hr [6.4 cu m/hr] |
| 1/2 x 3/4 | 190 cu ft/hr [5.4 cu m/hr] | 30 cu ft/hr [0.8 cu m/hr] | 290 cu ft/hr [8.2 cu m/hr] |
| 3/4 x 3/4 | 200 cu ft/hr [5.7 cu m/hr] | 30 cu ft/hr [0.8 cu m/hr] | 300 cu ft/hr [8.5 cu m/hr] |

^a Capacity based on 1000 Btu/cu ft, 0.64 specific gravity natural gas at 1 in. wc pressure drop [37.3 MJ/cu m, 0.64 specific gravity natural gas at 0.25 kPa pressure drop.

Use conversion factors in Table 2 to convert capacities for other gasses.

TABLE 2—GAS CAPACITY
CONVERSION FACTORS.

| Gas | Specific Gravity | Multiply Listed Capacity By |
|--------------|------------------|-----------------------------|
| Manufactured | 0.60 | 0.516 |
| Mixed | 0.70 | 0.765 |
| Propane | 1.53 | 1.62 |

TABLE 4—FLANGE PART NUMBERS.

| Inlet/Outlet Pipe Size | Flange Type | Part Number | |
|------------------------|-------------|--------------------|-----------------|
| | | Without Hex Wrench | With Hex Wrench |
| 1/2 inch NPT | Straight | 394599-6 | 393690-16 |
| | Elbow | 394599-3 | 393690-13 |
| 3/4 inch NPT | Straight | 394599-4 | 393690-14 |
| | Elbow | 394599-5 | 393690-15 |

NOTE: Flange kits include one flange with attached O-ring and fan mounting screw.

TABLE 3—TEMPERATURE RANGES AND REGULATOR TYPES.

| Model Number | Ambient Temperature Range | Regulator Type |
|--------------|-------------------------------------|------------------|
| VR8300A | 0° F to 175° F [-18° C to +79° C] | Standard-opening |
| VR8300C | 0° F to 175° F [-18° C to +79° C] | Step-opening |
| VR8300H | 0° F to 175° F [-18° C to +79° C] | Slow-opening |
| VR8300K | -40° F to 175° F [-40° C to +79° C] | Slow-opening |
| VR8300M | -40° F to 175° F [-40° C to +79° C] | Standard-opening |
| VR8300P | -40° F to 175° F [-40° C to +79° C] | Step-opening |
| VR8301 | 0° F to 175° F [-18° C to 79° C] | Standard-opening |

APPROVALS:

American Gas Association Design Certificate: UP-70-69A.
Canadian Gas Association Design Certificate: UP-70-69A.
Australian Gas Association Certificate: Applied for.
Delta C: Applied for.

Installation

WHEN INSTALLING THIS PRODUCT...

1. Read these instructions carefully. Failure to follow them could damage the product or cause a hazardous condition.
2. Check the ratings given in the instructions and on the product to assure the product is suitable for your application.
3. Assure installer is a trained, experienced service technician.
4. After installation is complete, use these instructions to check out product operation.



WARNING

FIRE OR EXPLOSION HAZARD CAN CAUSE PROPERTY DAMAGE, SEVERE INJURY, OR DEATH

Follow these warnings exactly.

1. Disconnect power supply before wiring to prevent electrical shock or equipment damage.
2. To avoid dangerous accumulation of fuel gas, turn off gas supply at the appliance service valve before starting Installation, and perform Gas Leak Test after completion of Installation.
3. Do not bend the pilot tubing at the gas control or pilot burner after compression fitting has been tightened, or gas leakage at the connection may result.
4. Always install sediment trap in gas supply line to prevent contamination of gas control.
5. Do not force the gas control knob. Use only your hand to push down the reset button or turn the gas control knob. Never use any tools. If the gas control knob or reset button will not operate by hand, to replace the gas control, contact a qualified service technician. Force or attempted repair may result in fire or explosion.



CAUTION

Never apply a jumper across or short the valve coil terminals. This may burn out the heat anticipator in the thermostat.

IMPORTANT: *These gas controls are shipped with protective seals over inlet and outlet tapings. Do not remove seals until ready to connect piping.*

Follow the appliance manufacturers instructions if available; otherwise, use the instructions provided below.

CONVERTING BETWEEN NATURAL AND LP GAS



WARNING

FIRE OR EXPLOSION HAZARD CAN CAUSE PROPERTY DAMAGE, SEVERE INJURY, OR DEATH

Do not use a gas control set for natural gas on LP gas or a gas control set for LP gas on natural gas.

To convert a gas control from natural gas to LP gas or from LP gas to natural gas, contact your Honeywell representative.

Standard- or slow-opening gas controls are converted from one gas to another with a conversion kit (ordered separately). Order part number 393691 to convert from natural to LP gas. Order part number 394588 to convert from LP to natural gas. Step-opening gas controls cannot be converted.

INSTALL ADAPTERS TO CONTROL

Install adapters on the gas control as follows:

Flanges

1. Choose the appropriate flange for your application.
2. Remove seal over gas control inlet or outlet.
3. Assure the O-ring fits in the flange groove. If the O-ring is not attached or is missing, do not use flange.
4. With O-ring facing gas control, align the screw holes on the gas control with the holes in the flange. Insert and tighten the screws provided with the flange. See Fig. 1. Tighten the screws to 25 inch pounds of torque to provide a gas-tight seal.

Bushings:

1. Remove the seal over the gas control inlet or outlet.
2. Apply moderate amount of good quality pipe compound to bushing, leaving two end threads bare. On LP installation, use compound resistant to LP gas. Do NOT use Teflon tape.
3. Insert bushing in gas control and thread pipe carefully into the bushing until tight.

Complete instructions below for piping, installing control, connecting pilot tubing, thermocouple and wiring. Make certain the leak test you perform on the control after completing the installation includes leak testing the adapters and screws. If you use a wrench on the valve after flanges are installed, use the wrench only on the flange, not on the control.

USING ADAPTERS TO SOLVE SWING RADIUS PROBLEMS

In some field service applications, it is difficult or impossible to thread the gas control onto the gas supply pipe because of space limitations. This problem can be resolved in many instances by using an adapter. The adapter is installed on the end of the supply pipe in place of the gas control, following the same precautions and instructions that are used for installing the gas control. After the adapter is installed, the gas control is attached to the adapter as outlined above. Note that using an adapter increases the overall length of the gas control.

Fig. 1—Install flange to gas control.

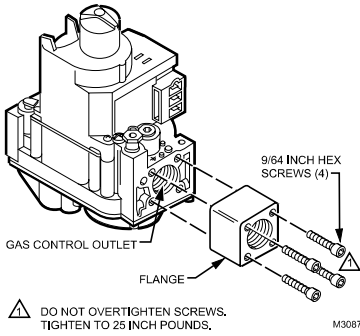

CHOOSE GAS CONTROL LOCATION

Do not locate the gas control where it may be affected by steam cleaning, high humidity, dripping water, corrosive chemicals, dust or grease accumulation, or excessive heat.

To assure proper operation, follow these guidelines:

- Locate gas control in a well-ventilated area.
- Mount the gas control high enough above the cabinet bottom to avoid exposure to flooding or splashing water.
- Assure the ambient temperature does not exceed the ambient temperature ratings for each component.
- Cover the gas control if the appliance is cleaned with water, steam, or chemicals or to avoid dust and grease accumulation.
- Avoid locating gas control where exposure to corrosive chemical fumes or dripping water is likely.

Locate the gas control in the appliance vestibule on the gas manifold. In replacement applications, locate the gas control in the same location as the old gas control.

Install Piping to Gas Control

All piping must comply with local codes and ordinances or with the National Fuel Gas Code (ANSI Z223.1 NFPA No. 54), whichever applies. Tubing installation must comply with approved standards and practices.

1. Use new, properly reamed pipe free from chips. If tubing is used, assure the ends are square, deburred and clean. All tubing bends must be smooth and without deformation.
2. Run pipe or tubing to the gas control. If tubing is used, obtain a tube-to-pipe coupling to connect the tubing to the gas control.
3. Install sediment trap in the supply line to the gas control. See Fig. 2.

Install Gas Control

1. Mount the gas control 0-90 degrees, in any direction from the upright position of the gas control knob.
2. Mount the gas control so gas flow is in the direction of the arrow on the bottom of the gas control.
3. Thread pipe the amount shown in Table 5 for insertion into gas control.

IMPORTANT: Do not thread pipe too far. Valve distortion or malfunction may result if the pipe is inserted too deeply into the gas control. Refer to Fig. 3.

TABLE 5—NPT PIPE THREAD LENGTH IN IN.

| Pipe Size | Thread Pipe This Amount | Maximum Depth Pipe Can Be Inserted Into Control |
|-----------|-------------------------|---|
| 3/8 | 9/16 | 3/8 |
| 1/2 | 3/4 | 1/2 |
| 3/4 | 13/16 | 3/4 |

4. Apply a moderate amount of good quality pipe compound (*do not* use Teflon tape) to pipe only, leaving two end threads bare. On LP installations, use compound resistant to LP gas.

5. Remove seals over gas control inlet and outlet if necessary.

6. Connect pipe to gas control inlet and outlet. Use wrench on the square ends of the gas control. If an adapter is used, place wrench on adapter rather than on gas control. See Figs. 4 and 5.

Fig. 2—Sediment trap installation.

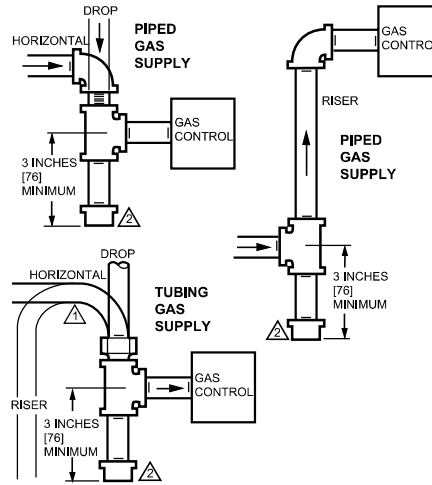

- ⚠ ALL BENDS IN METALLIC TUBING SHOULD BE SMOOTH.
- ⚠ CAUTION: SHUT OFF THE MAIN GAS SUPPLY BEFORE REMOVING END CAP TO PREVENT GAS FROM FILLING THE WORK AREA. TEST FOR GAS LEAKAGE WHEN INSTALLATION IS COMPLETE. M3077

Fig. 3—Use moderate amount of pipe compound.

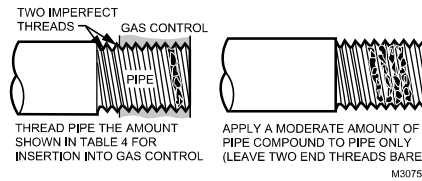

Fig. 4—Top view of gas control.

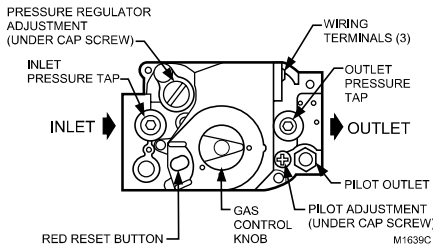

Fig. 6—Always use new compression fitting.

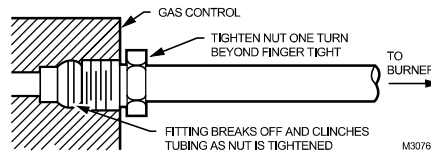
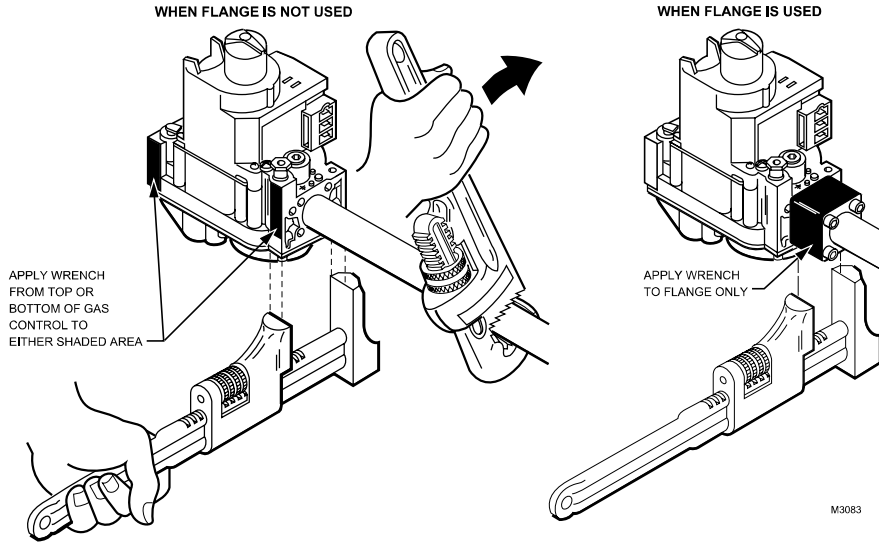

Fig. 5—Proper use of wrench on gas control.



Connect Pilot Gas Tubing

1. Cut tubing to desired length and bend as necessary for routing to pilot burner.

CAUTION

Do not make sharp bends or deform the tubing. Do not bend tubing at gas control or pilot burner after compression fitting is tightened, because this may result in gas leakage at the connection.

2. Square off and remove burrs from the end of the tubing.

3. Unscrew compression fitting from the pilot outlet (Fig. 4). Slip the compression fitting over the tubing and slide out of the way.

NOTE: When replacing a gas control, cut off old compression fitting and replace with the new compression fitting

provided on the gas control. Never use the old compression fitting because it may not provide a gas-tight seal.

4. Push tubing into the pilot gas tapping on the outlet end of the control until it bottoms. While holding tubing all the way in, slide compression fitting into place and engage threads—turn until finger tight. Then tighten one more turn with a wrench. Do not overtighten. See Fig. 6.

5. Connect the other end of the tubing to the pilot burner according to the pilot burner manufacturers instructions.

Connect Thermocouple

Connect thermocouple lead as shown in Fig. 7. See Tables 6 and 7. This is an electrical connection and must be clean and dry. Never use pipe compound. Tighten only 1/4 turn beyond finger tight to give good electrical continuity. Do not overtighten.

Fig. 7—Installing thermocouple to the power unit.

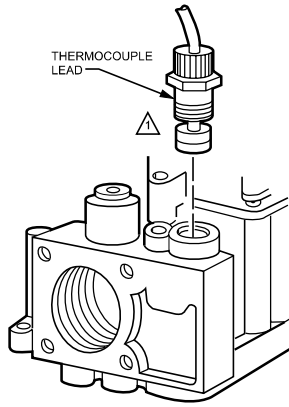

⚠ THIS IS AN ELECTRICAL CONNECTION AND MUST BE CLEAN AND DRY. DO NOT USE PIPE COMPOUND. M8576

3. Adjust thermostat heat actuator to 0.70 rating stamped on valve operator.

Fig. 8—VR8300 wiring connections for 24 volt control.

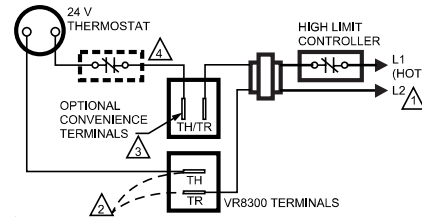

- ⚠ POWER SUPPLY. PROVIDE DISCONNECT MEANS AND OVERLOAD PROTECTION AS REQUIRED.
- ⚠ DO NOT JUMPER THESE TERMINALS. THIS SHORTS VALVE COIL AND MAY BURN OUT ANTICIPATOR IN THERMOSTAT.
- ⚠ CONVENIENCE TERMINALS SERVE AS A TIE POINT ONLY. THEY ARE NOT INTERNALLY WIRED TO THE CONTROL CIRCUIT OR TO GROUND.
- ⚠ OPTIONAL HIGH LIMIT. M8581

WIRING

! CAUTION

Disconnect power supply before making wiring connections to prevent electrical shock or equipment damage.

Follow the wiring instructions furnished by the appliance manufacturer, if available, or use the general instructions.

All wiring must comply with applicable electrical codes and ordinances.

1. Check the power supply rating on the gas control and make sure it matches the available supply. Install transformer, thermostat, and other controls as required.

2. Connect control circuit to gas control terminals. See Figs. 4, 8, and 9.

Fig. 9—VR8301 wiring connections for 24 volt control.

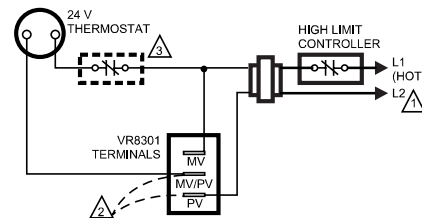

- ⚠ POWER SUPPLY. PROVIDE DISCONNECT MEANS AND OVERLOAD PROTECTION AS REQUIRED.
- ⚠ DO NOT JUMPER THESE TERMINALS. THIS SHORTS VALVE COIL AND MAY BURN OUT ANTICIPATOR IN THERMOSTAT.
- ⚠ OPTIONAL HIGH LIMIT. M8580

TABLE 6—MAXIMUM LENGTH OF SUPPLEMENTARY LIMIT LEADWIRES WHEN USING Q340A THERMOCOUPLE.

| Thermocouple Length | | Maximum Leadwire Length x 2 (Wires) | | | | | |
|---------------------|--------|-------------------------------------|--------|------------|--------|------------|--------|
| | | Awg No. 14 | | Awg No. 16 | | Awg No. 18 | |
| Inches | Meters | Inches | Meters | Inches | Meters | Inches | Meters |
| 18 | 0.5 | .35 | 0.9 | 22 | 0.6 | 13 | 0.3 |
| 24 | 0.6 | .29 | 0.7 | 18 | 0.5 | 11 | 0.3 |
| 30 | 0.8 | .23 | 0.6 | 15 | 0.4 | 9 | 0.2 |
| 36 | 0.9 | .17 | 0.4 | 11 | 0.3 | 6 | 0.2 |
| 48 | 1.2 | DO NOT USE. | | | | | |
| 60 | 1.5 | | | | | | |

TABLE 7—MAXIMUM LENGTH OF SUPPLEMENTARY LIMIT LEADWIRES
WHEN USING Q309A THERMOCOUPLE.

| Thermocouple Length | | Maximum Leadwire Length x 2 (Wires) | | | | | |
|---------------------|--------|-------------------------------------|--------|------------|--------|------------|--------|
| | | Awg No. 14 | | Awg No. 16 | | Awg No. 18 | |
| Inches | Meters | Inches | Meters | Inches | Meters | Inches | Meters |
| 12 | 0.3 | 47 | 1.2 | 30 | 0.8 | 18 | 0.5 |
| 18 | 0.5 | 41 | 1.0 | 26 | 0.7 | 16 | 0.4 |
| 24 | 0.6 | 35 | 0.9 | 22 | 0.6 | 14 | 0.4 |
| 30 | 0.8 | 29 | 0.8 | 18 | 0.5 | 11 | 0.3 |
| 36 | 0.9 | 23 | 0.6 | 15 | 0.4 | 9 | 0.2 |
| 40 | 1.0 | 19 | 0.5 | 12 | 0.3 | 7 | 0.2 |
| 48 | 1.2 | 11 | 0.3 | 7 | 0.2 | | |
| 60 | 1.5 | DO NOT USE. | | | | | |

Start-up and Checkout



WARNING

FIRE OR EXPLOSION HAZARD CAN CAUSE PROPERTY DAMAGE, SEVERE INJURY, OR DEATH

1. Do not force the gas control knob. Use only your hand to push down the reset button or turn the gas control knob. Never use any tools.
2. If the gas control knob or reset button will not operate by hand, or if the reset button stays depressed after it is released, to replace the gas control call a qualified service technician.

GAS CONTROL KNOB SETTINGS

The gas control knob has three settings:

OFF: Prevents pilot and main burner gas flow.

PILOT: Permits pilot gas flow only. Gas control knob must be held depressed or the thermocouple must be heated sufficiently to hold the safety control valve open.

ON: Permits main burner and pilot gas flow. Gas control and thermostat control main burner gas flow.

NOTE: Gas controls are shipped with the gas control knob in the ON position.

PERFORM GAS LEAK TEST



WARNING

FIRE OR EXPLOSION HAZARD CAN CAUSE PROPERTY DAMAGE, SEVERE INJURY, OR DEATH

Check for gas leaks with rich soap and water solution any time work is done on a gas control.

GAS LEAK TEST

1. Paint all pipe connections upstream of the gas control with a rich soap and water solution. Bubbles indicate a gas leak.
2. If a gas leak is detected, tighten the pipe connection.







CAUTION

Stand clear while lighting main burner to prevent injury caused from hidden gas leaks that could cause flashback in the appliance vestibule.



3. Light the main burner.
4. With the main burner in operation, paint all pipe joints (including adapters) and gas control inlet and outlet with rich soap and water solution.
5. If another gas leak is detected, tighten adapter screws, joints, and pipe connections.
6. If gas leak cannot be stopped, turn the gas control knob clockwise  to off.
7. Replace the leaking part.
8. Perform the gas leak test.

LIGHT THE PILOT BURNER FLAME

1. Turn the gas control knob clockwise  to OFF. Wait five minutes to dissipate any unburned gas. Sniff around the appliance near the floor. Do not relight the pilot flame if you smell gas.
2. Turn the gas control knob counterclockwise  to PILOT. Push down and hold the gas control knob while lighting the pilot flame.
3. Hold the gas control knob down about one minute, then release.
 - If the pilot flame goes out, turn the gas control knob clockwise  to OFF and repeat steps one through three.
 - If pilot flame remains lit, turn the gas control knob counterclockwise  to ON.

ADJUST THE PILOT BURNER FLAME

The pilot flame should envelop 3/8 to 1/2 in. [10 to 13 mm] of the thermocouple tip. Refer to Fig. 10. To adjust the pilot flame:

1. Remove the pilot adjustment cover screw. Refer to Fig. 5.
2. Turn the inner adjustment screw clockwise , to decrease or counterclockwise  to increase the pilot flame.
3. Be sure to replace the cover screw after adjustment and tighten firmly.

LIGHT MAIN BURNER

Follow the appliance manufacturer instructions or set the thermostat setting above room temperature to call for heat.

Fig. 10—Proper flame adjustment.

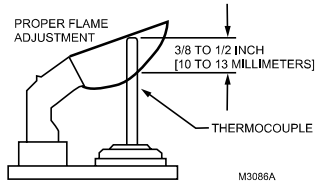

CHECK AND ADJUST GAS INPUT TO MAIN BURNER

CAUTION

1. Do not exceed the input rating stamped on the appliance nameplate, or the manufacturers recommended burner orifice pressure for the size orifice(s) used. Make sure the main burner primary air supply is properly adjusted for complete combustion (refer to the appliance manufacturers instructions).
2. WHEN CHECKING GAS INPUT BY CLOCKING THE GAS METER:
 - Make sure that the only gas flow through the meter is that of the appliance being checked.
 - Make sure that other appliances are turned off and that the pilot burners are extinguished (or deduct the gas consumptions from the meter reading).
 - Convert the flow rate to Btuh as described in the Gas Controls Handbook, (form 70-2602), and compare to the Btuh input rating on the appliance nameplate.
3. WHEN CHECKING GAS INPUT WITH A MANOMETER (PRESSURE GAUGE):
 - Make sure the gas control knob is in the PILOT position before removing the outlet pressure tap plug to connect the manometer.
 - Turn the gas control knob back to PILOT when removing the manometer and replacing the outlet pressure tap plug.
 - Shut off the gas supply at the appliance service valve or, for LP gas, at the gas tank before removing the outlet pressure tap plug and before disconnecting the manometer and replacing the outlet pressure tap plug.

Standard-Opening and Slow-Opening Pressure Regulator

1. The gas control outlet pressure should match the manifold pressure listed on the appliance nameplate.
2. With the main burner operating, check the gas control flow rate using the meter clocking method or check the gas pressure using a manometer connected to the gas control outlet pressure tap. Refer to Fig. 4.
3. If necessary, adjust the pressure regulator to match the appliance rating. Refer to Table 8 or 9 for the factory set nominal outlet pressures and adjustment ranges.
 - a. Remove the pressure regulator adjustment cap screw.
 - b. Using a screwdriver, turn the inner adjustment screw clockwise (↻) to increase or counterclockwise (↻) to decrease the main burner gas pressure.
 - c. Always replace the cap screw and tighten firmly to be sure of proper operation.
4. If the desired outlet gas pressure or gas flow rate cannot be achieved by adjusting the gas control, check the gas control inlet pressure using a manometer at the inlet pressure tap. If the inlet pressure is in the normal range (refer to Table 8 or 9), replace the gas control. Otherwise, take the necessary steps to provide proper gas pressure to the gas control.

Step-Opening Pressure Regulator

1. The gas control outlet pressure should match the manifold pressure listed on the appliance nameplate.
2. With the main burner operating, check the gas control flow rate using the meter clocking method or check the gas pressure using a manometer connected to the gas control outlet pressure tap. Refer to Fig. 4.
3. If necessary, adjust the pressure regulator to match the appliance rating. Refer to Table 8 or 9 for factory set nominal outlet pressures and adjustment ranges.
 - a. Remove the pressure regulator adjustment cap screw.
 - b. Using a screwdriver, turn the inner adjustment screw clockwise (↻) to increase or counterclockwise (↻) to decrease the main burner gas pressure.
 - c. Always replace the cap screw and tighten firmly to safeguard proper operation.
4. If desired outlet pressure or flow rate cannot be achieved by adjusting the gas control, check the inlet pressure using a manometer at inlet pressure tap or upstream of the gas control. If the inlet pressure is in the normal range (refer to Table 8 or 9), replace the existing gas control. Otherwise, take the necessary steps to provide proper gas pressure to the gas control.
5. Carefully check main burner lightoff at the step pressure. Be sure the main burner lights smoothly and without flash back to the orifice and that all ports remain lit. Cycle the main burner several times, allowing at least 30 seconds between cycles for the regulator to resume the step function. Repeat after allowing main burner to cool. Readjust the full rate outlet pressure, if necessary, to improve lightoff characteristics.

TABLE 8—PRESSURE REGULATOR SPECIFICATION PRESSURES IN IN. WC.

| Model | Nominal Inlet Pressure Type of Gas | Nominal Inlet Pressure Range | Outlet Pressure | | | |
|---------------------------|---------------------------------------|---------------------------------|-------------------------|-----------|---------------|------------|
| | | | Nominal Factory Setting | | Setting Range | |
| | | | Step | Full Rate | Step | Full Rate |
| Standard, Slow opening | Natural | 5.0 - 7.0 | — | 3.5 | — | 3.0 - 5.0 |
| | LP | 12.0 - 14.0 | — | 11.0 | — | 8.0 - 12.0 |
| Step-opening | Natural | 5.0 - 7.0 | 0.9 | 3.5 | — | 3.0 - 5.0 |
| | LP | 12.0 - 14.0 | 2.2 | 11.0 | — | 8.0 - 12.0 |

TABLE 9—PRESSURE REGULATOR SPECIFICATION PRESSURES IN kPa.

| Model | Type of Gas | Nominal Inlet Pressure Range | Outlet Pressure | | | |
|---------------------------|-------------|---------------------------------|-------------------------|-----------|---------------|-----------|
| | | | Nominal Factory Setting | | Setting Range | |
| | | | Step | Full Rate | Step | Full Rate |
| Standard, Slow opening | Natural | 1.2 - 1.7 | — | 0.9 | — | 0.7 - 1.2 |
| | LP | 2.9 | — | 2.7 | — | 2.0 - 3.0 |
| Step-opening | Natural | 1.2 - 1.7 | 0.2 | 0.9 | — | 0.7 - 1.2 |
| | LP | 2.9 - 3.9 | 0.9 | 2.7 | — | 2.0 - 3.0 |

CHECK SAFETY SHUTDOWN PERFORMANCE



WARNING

FIRE OR EXPLOSION HAZARD CAN CAUSE PROPERTY DAMAGE, SEVERE INJURY, OR DEATH

Perform the safety shutdown test any time work is done on a gas system.

1. Place the gas control knob in the PILOT position. Main burner should go off and pilot should remain lit.
2. Extinguish pilot flame. Pilot gas flow should stop within 2-1/2 minutes. Safety shutoff of pilot gas proves complete shutdown because safety shutoff valve prevents main burner and pilot gas flow.
3. Relight pilot burner and operate system through one complete cycle to make sure all controls operate properly.

Maintenance



WARNING

FIRE OR EXPLOSION HAZARD CAN CAUSE PROPERTY DAMAGE, SEVERE INJURY, OR DEATH

Improper cleaning or reassembly can cause gas leakage. When cleaning, be sure that control is reassembled properly and perform gas leak test.

Regular preventive maintenance is important in applications such as in the commercial cooking and agricultural and industrial industries that place a heavy load on system controls, because:

- In many such applications, particularly commercial cooking, the equipment operates 100,000 to 200,000 cycles per year. Such heavy cycling can wear out the gas control in one to two years.
- Exposure to water, dirt, chemicals and heat can damage the gas control and shut down the control system.

The maintenance program should include regular check-out of the gas control as outlined in Start-up and Checkout section, checkout the control system as described in the appliance manufacturers literature. Maintenance frequency must be determined individually for each application. Some considerations are:

- Cycling frequency. Appliances that may cycle 100,000 times annually should be checked monthly.
- Intermittent use. Appliances that are used seasonally should be checked before shutdown and again before the next use.
- Consequence of *unexpected shutdown*. Where the cost of an unexpected shutdown would be high, the system should be checked more often.
- *Dusty, wet, or corrosive environment*. Since these environments can cause the gas control to deteriorate more rapidly, the system should be checked more often.

The gas control should be replaced if:

- It does not perform properly on checkout or troubleshooting.
- The gas control knob is hard to turn or push down, or it fails to pop back up when released.
- The gas control is likely to have operated for more than 200,000 cycles.



WARNING

FIRE OR EXPLOSION HAZARD CAN CAUSE PROPERTY DAMAGE, SEVERE INJURY OR DEATH

Do not disassemble the gas control; it contains no replaceable components. Attempted disassembly or repair may damage the gas control.



CAUTION

Do not apply a jumper across or short the valve coil terminals. Doing so can burn out the heat anticipator in the thermostat.

IMPORTANT: Allow 60 seconds after shutdown before re-energizing step-opening model to assure lightoff at step pressure.

IF THE PILOT BURNER FLAME WILL NOT LIGHT

1. Assure the main gas supply valve is open and the pilot gas supply line is purged of air.
2. Attempt to light pilot burner flame following procedures in the Lighting the Pilot Burner Flame section. If pilot burner flame still will not light:
 - a. Check the pilot gas adjustment screw. If closed, readjust the pilot flame. Refer to Adjust the Pilot Burner Flame section.
 - b. Perform the Gas Leak Test at the compression fitting. If a gas leak is detected, replace the old compression fitting or tighten the newly installed one. Refer to Fig. 4.
 - c. Assure that the pilot burner tubing or pilot burner orifice is not clogged.

IF THE PILOT BURNER FLAME GOES OUT WHEN THE GAS CONTROL KNOB IS RELEASED

1. Assure the gas control knob is held in at least one minute to allow the thermocouple time to heat.
2. Check the pilot burner flame adjustment. Refer to Adjust the Pilot Burner Flame section.
3. Check the wiring between the thermocouple and the gas control valve operator.
4. Assure thermocouple connection to the power unit is tightened one-fourth turn beyond finger tight.
5. If pilot burner flame still goes out, measure the open and closed thermocouple output voltage. Compare it to the acceptable range charts in the thermocouple specifications or in the Gas Controls Handbook. Replace the thermocouple if voltages are outside the acceptable range.
6. Check the power unit resistance. If above 11 ohms, replace the gas control.

IF THE MAIN BURNER WILL NOT COME ON WITH A CALL FOR HEAT

1. Be sure the gas control knob is in the ON position.
2. Adjust the thermostat several degrees above room temperature.

3. Use an ac voltmeter to measure the voltage across terminals TH and TR or MV/PV and MV. If:

- a. No voltage is present, check the control circuit for proper operation.
 - b. 24 Vac is present, but first operator did not *click* open, check for excessive inlet gas pressure. If inlet gas pressure is correct, replace the gas control.
4. Measure the open and closed thermocouple output voltages and compare to the acceptable range charts in the thermocouple specifications or in the Gas Controls Handbook. Replace the thermocouple if voltages are outside the acceptable range.
5. Measure the open and closed thermocouple output voltages and compare to the acceptable range charts in the thermocouple specifications or in the Gas Controls Handbook. Replace the thermocouple if voltages are outside the acceptable range.

IF THE MAIN BURNER IS OVERFIRING

Adjust the gas control pressure regulator to the correct pressure. If the regulator cannot be adjusted and supply the pressure is in the normal range, replace the gas control.

INSTRUCTIONS TO THE HOMEOWNER



CAUTION

FIRE OR EXPLOSION HAZARD CAN CAUSE PROPERTY DAMAGE, SEVERE INJURY, OR DEATH

Follow these warnings exactly:

1. Pilot burner flame must be lit manually. Follow these instructions exactly.
2. Before lighting pilot burner flame, smell around the appliance for gas. Be sure to smell next to floor because LP gas is heavier than air.
3. IF YOU SMELL GAS:
 - Turn off the gas supply at the appliance service valve. On LP gas systems, turn off the gas supply at the gas tank.
 - Do not light any appliances in the house.
 - Do not touch electrical switches or use the phone.
 - Leave the building and use a neighbor's phone to call your gas supplier.
 - If you cannot reach your gas supplier, call the fire department.
4. Do not force the gas control knob. Use only your hand to push down or turn the gas control knob. Never use any tools. If the gas control knob will not operate by hand, the gas control should be replaced by a qualified service technician. Force or attempted repair can result in a fire or explosion.
5. Replace the gas control in case of any physical damage, tampering, bent terminals, missing or broken parts, stripped threads, evidence of exposure to heat or if flooded by water.

IMPORTANT: Follow the operating instructions provided by the manufacturer of your heating appliance. The information below will be of assistance in a typical gas control application, but the specific controls used and the procedures outlined by the manufacturer or your appliance may differ and require special instructions.

LIGHTING THE PILOT BURNER FLAME

Stop: Read the warnings above.

The pilot burner flame must be lit manually. If the pilot burner flame has gone out, follow these instructions exactly:

1. Set the thermostat to its lowest setting.
2. Disconnect all electric power to the appliance.
3. Remove the gas control access panel.
4. Push in the gas control knob slightly and turn clockwise  to OFF.

NOTE: The gas control knob can not be turned from PILOT to OFF unless it is pushed in slightly. Do not force the gas control knob.

5. Wait five minutes to clear out any unburned gas. If you then smell gas, STOP! Follow step 3 in the Warnings at the beginning of the Instructions to the Homeowner section. If you do not smell gas, continue with the next step.

6. Remove the pilot burner access panel located below and behind the gas control.

7. Find the pilot burner by following the metal tube from the gas control. The pilot burner is located between the two burner tubes behind the pilot burner access panel.

8. Turn the gas control knob counterclockwise  to PILOT.

9. Push and hold the gas control knob all the way in. Immediately light the pilot burner flame with a match and continue holding the gas control knob in for one minute after the pilot burner flame is lit.

10. Release the gas control knob and it will pop back up. The pilot burner flame should remain lit. If pilot burner flame goes out, repeat steps one through ten.

- If the gas control knob does not pop up when released, stop immediately and call your service technician or gas supplier.
- If the pilot flame will not stay lit after several tries, turn the gas control knob to OFF and call your service technician or gas supplier.

11. Turn the gas control knob counterclockwise  to ON.

12. Replace the pilot burner access panel.
13. Replace the gas control access panel.
14. Reconnect all electric power to the appliance.
15. Set the thermostat to the desired setting.

TURNING OFF THE APPLIANCE

VACATION SHUTDOWN: Set the thermostat to the desired room temperature while you are away.

COMPLETE SHUTDOWN: Push the gas control knob in slightly and turn clockwise  to OFF. Do not force. Appliance will completely shut off. Follow the Lighting The Pilot Burner Flame procedures to resume normal operation.

Honeywell

Helping You Control Your World

Home and Building Control

Honeywell Inc.
1985 Douglas Drive North
Golden Valley, MN 55422

Home and Building Control

Honeywell Limited—Honeywell Limitée
740 Ellesmere Road
Scarborough, Ontario
M1P 2V9

QUALITY IS KEY

Printed in U.S.A

www.honeywell.com