

Submittal Package

Viega PureFlow[®] Crimp

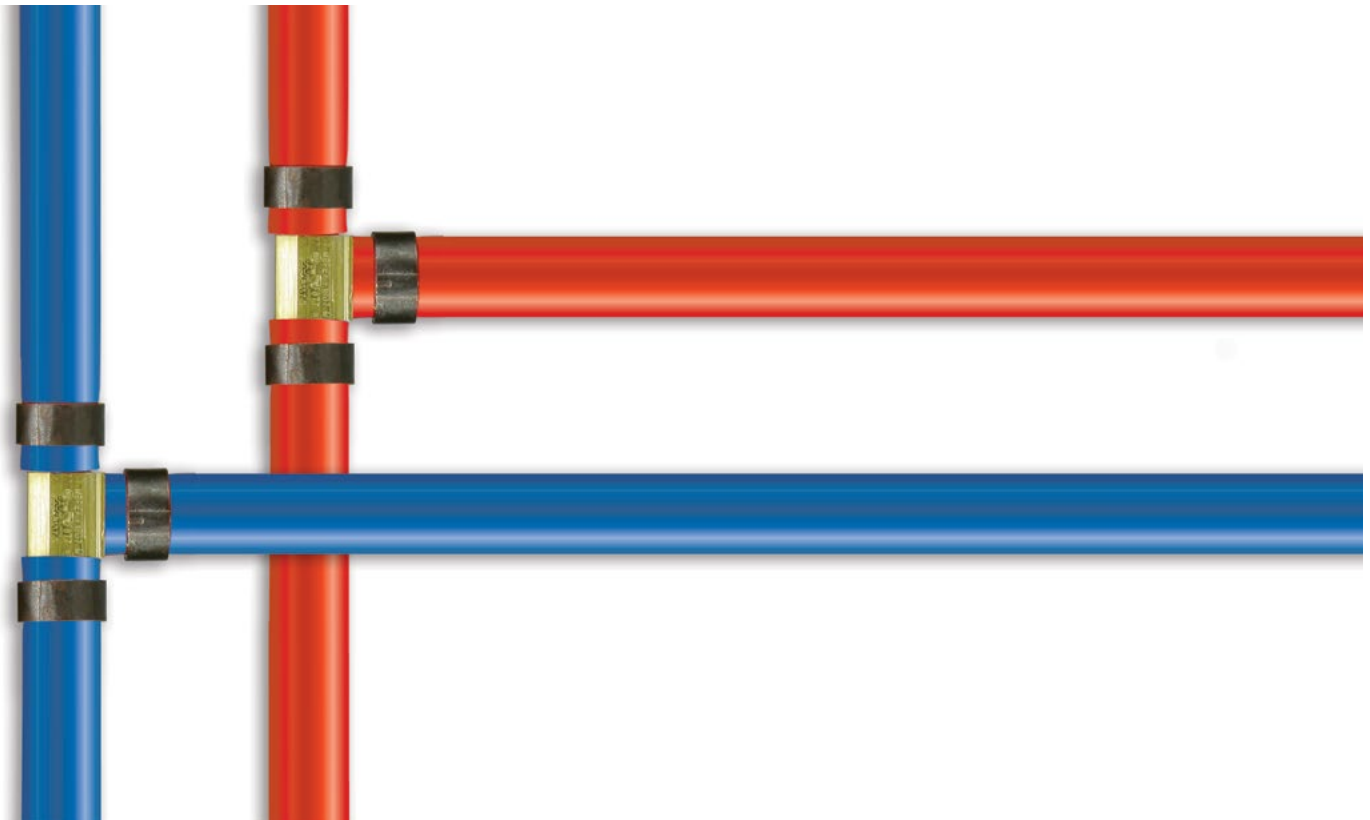

Project _____ **Date** _____

Engineer _____ **Contractor** _____

Submitted by _____

Approved by _____ **Date** _____ **Approved by** _____ **Date** _____

Table of Contents

Chilled Water
 Hydronic Heating
 Fire Protection
 Low-Pressure Steam
 Compressed Air
 Industrial Gases
 Vacuum

| | | |
|---|---|-----------|
| 1 | System Data Sheet _____ | 3 |
| | PureFlow Crimp _____ | 3 |
| 2 | Product Instructions _____ | 4 |
| | PureFlow Crimp Connections _____ | 4 |
| 3 | Engineering Specifications _____ | 5 |
| | PureFlow System _____ | 5 |
| 4 | Dimensional Documents _____ | 9 |
| | PureFlow Crimp Fittings _____ | 9 |
| | PureFlow Crimp PolyAlloy Fittings _____ | 16 |
| 5 | Warranty _____ | 20 |
| | PureFlow Water System _____ | 20 |



Zero Lead identifies Viega products meeting the lead free requirements of NSF 61-G through testing under NSF/ANSI 372 (0.25% or less maximum weighted average lead content.)



Viega products are designed to be installed by licensed and trained plumbing and mechanical professionals who are familiar with Viega products and their installation. **Installation by non-professionals may void Viega LLC's warranty.**



This document is subject to updates. For the most current Viega technical literature please visit www.viega.us.

1 System Data Sheet

PureFlow Crimp



Viega PureFlow Crimp fittings are available in ECO Brass and polymer materials with excellent chlorine- and corrosion resistant properties.

PureFlow Crimp fittings are available in sizes $\frac{3}{8}$ ", $\frac{1}{2}$ ", $\frac{3}{4}$ " and 1" in elbows, tees, adapters, couplings, PolyAlloy manifolds, and valves.

Components

- Eco Brass fittings use zero-lead alloy
- PolyAlloy fittings use performance-grade polymer (Acudel® and Radel® R)
- Copper crimp rings

Operating Parameters

- Operating Temperature: 180°F max (potable)
- Operating Pressure: 160 psi max at 73°F
100 psi max at 180°F
- Test Pressure: Recommended: 100 psi
Maximum: 160 psi

Listings and Certifications

- | | |
|-----------------------|------------------------|
| ■ ASTM E84 | ■ CSA B137.5 |
| ■ ASTM F1807 | ■ HUD MR-1276 |
| ■ ASTM F2159 | ■ ICC-ES PMG 1038/1015 |
| ■ CAN/ULC S101/S102.2 | ■ NSF-pw 372 |

Compliant With

- International Mechanical Code (IMC)
- International Plumbing Code (IPC)
- International Residential Code (IRC)
- National Fire Protection Association - 13D (NFPA)
- National Standard Plumbing Code (NSPC)
- Uniform Mechanical Code (UMC)
- Uniform Plumbing Code (UPC)
- Housing for Urban Development (HUD)
- Canadian Standards Association (CSA)
- National Plumbing Code of Canada (NPCC)
- National Building Code of Canada (NBCC)

Approved Applications

- Hot and cold potable water
- Rainwater/gray water

For more specific information on applications for PureFlow systems, contact Viega Technical Services at 1-800-976-9819.

Viega's PureFlow systems meet or exceed all requirements of ASTM F876/877 and are approved for installations above and below ground.

Recommended Tools

- Viega PureFlow Crimp Hand Tools ($\frac{3}{8}$ " to 1")

2 Product Instructions

PureFlow Crimp Connections

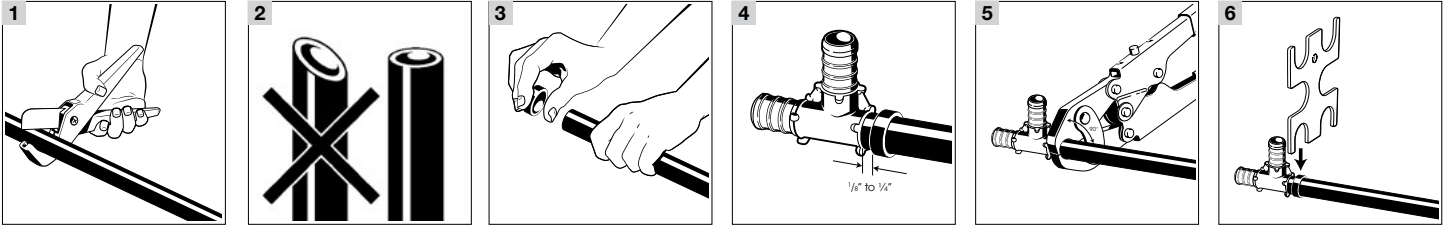

Making Viega PureFlow Crimp Connections

- 1 The tubing should be cut squarely and evenly without burrs. Uneven, jagged or irregular cuts will produce unsatisfactory connections.
- 2 The diagram shows a correctly cut tube compared with an incorrectly cut tube.
- 3 Slide the crimp ring onto the tubing and insert the fitting into the tube to the shoulder or tube stop.
- 4 Position the ring $\frac{1}{8}$ " to $\frac{1}{4}$ " from the end of the tubing.
- 5 The ring must be attached straight. Center the crimping tool jaws exactly over the ring. Keep the tool at 90° and close the handles completely.

CAUTION!

Do not crimp twice!

- 6 When checking crimp connections with a caliper (GO/NO GO gauge), push the gauge STRAIGHT DOWN over the crimped ring. NEVER slide the gauge in from the side. Do not attempt to gauge the crimp at the jaw overlap area. The overlap area is indicated by a slight removal of the blackening treatment. A **crimp is acceptable** if the GO gauge fits the ring and the NO GO does not. A **crimp is unacceptable** if the GO gauge does not fit the ring or the NO GO gauge does fit. An incorrect crimp must be cut out of the tubing and replaced. If you check the crimp connections with a micrometer or caliper, use the dimensions shown in the table.

i Crimp outside diameters should fall within the dimensions listed in the table below when measured with a micrometer or caliper.

| Crimp Diameter Dimensions | | |
|---------------------------|--------------|--------------|
| Ring Size (in) | Minimum (in) | Maximum (in) |
| $\frac{3}{8}$ | 0.58 | 0.60 |
| $\frac{1}{2}$ | 0.70 | 0.72 |
| $\frac{3}{4}$ | 0.95 | 0.96 |
| 1 | 1.18 | 1.19 |

3 Engineering Specifications

PureFlow System

Part 1: General

1.1 Summary

This specification covers branch and main, parallel water distribution systems (ManaBloc), cross-linked polyethylene tubing, and fittings using PureFlow press and PureFlow crimp technology for hot and cold water distribution systems. The system is assembled when the fitting barb is inserted fully into the tubing and either a stainless press sleeve or copper crimp ring is pressed/cripped over the tubing and fitting using the appropriate tool to create a leak proof permanent joint.

1.2 References

ANSI/UL 263: Fire test of building construction and materials.

Standard methods of fire endurance tests of building construction and materials.

ASTM E84: surface burning characteristics of building materials

ASTM F1807: specification for metal insert fittings utilizing a copper crimp ring for SDR9 cross-linked polyethylene (PEX) tubing

ASTM F2023: test method for evaluating the oxidative resistance of cross-linked (PEX) tubing and systems to hot chlorinated water.

ASTM F2159: specification for plastic insert fittings utilizing a copper crimp ring for SDR9 cross-linked polyethylene (PEX) tubing

ASTM F3347: Standard Specification for Metal Press Insert Fittings with Factory Assembled Stainless Steel Press Sleeve for SDR9 Cross-linked Polyethylene (PEX) Tubing

ASTM F3348: Standard Specification for Plastic Press Insert Fittings with Factory Assembled Stainless Steel Press Sleeve for SDR9 Cross-linked Polyethylene (PEX) Tubing

ASTM F876: specification for cross-linked polyethylene (PEX) tubing

ASTM F877: specification for cross-linked polyethylene (PEX) plastic hot and cold water distribution systems.

AWWA C904: cross-linked polyethylene (PEX) pressure pipe, ½ in. (12 mm) through 3 in. (76 mm), for water service.

CAN/ULC S102.2: standard method of testing for surface burning characteristics of flooring, floor covering and miscellaneous materials and assemblies.

CSA CAN/CSA B137.5: cross-linked polyethylene (PEX) tubing systems for pressure applications.

cULus - UL 1821: listing for multipurpose residential fire sprinkler systems (Viega Pureflow PEX black with PureFlow press bronze and polymer fittings in sizes ¾ to 2)

IAPMO Uniform Mechanical Code

IAPMO Uniform Plumbing Code

ICC International Mechanical Code

ICC International Plumbing Code

NAPHCC National Standard Plumbing Code

NSF 14: plastic piping component and related materials

NSF 61: drinking water system components – health effects

1.3 Quality Assurance

A. The installer shall be a qualified installer, licensed within the jurisdiction, and familiar with the installation of cross-linked polyethylene (PEX) tubing systems.

B. The installation of cross-linked polyethylene (PEX) tubing for hot and cold water distribution systems shall conform to the requirements of the ICC International Plumbing Code or IAPMO Uniform Plumbing Code.

1.4 Delivery, Storage, And Handling

- A. The cross-linked polyethylene (PEX) tubing shall be shipped to the job site on truck or in such a manner to protect the tubing. The cross-linked polyethylene fittings and manifolds shall not be handled roughly during shipment. The tubing and fittings shall be unloaded with reasonable care.
- B. Cross-linked polyethylene plastic tubing and fittings shall be stored in a flat, dry, well ventilated location, not exposed to direct sunlight. Normal care in handling shall be exercised to avoid abuse of the tubing. The tubing and fittings shall not be thrown or dropped on the ground, walked on, or dragged.

1.5 Project Conditions

- A. The location of a manifold with valves shall be accessible and in an area not subject to freezing. Proper support of the manifold shall be provided.
- B. PEX tubing should not be left exposed in direct sunlight for extended periods of time – short periods not to exceed 6 months are permissible.
- C. Plastic manifolds and fittings should not be left exposed in direct sunlight for extended periods of time — short periods not to exceed 15 days are permissible.

1.6 Warranty

- A. The tubing and fittings manufacturer shall warrant that the tubing and fittings are free from defects and conform to the designated standard. The warranty shall only be applicable to tubing and fittings installed in accordance with the manufacturer’s installation instructions.
- B. The manufacturer of the tubing and fittings shall not be responsible for improper use, handling, or installation of the products.

Part 2: Products

2.1 Manufacturer

Viega LLC
 585 Interlocken Blvd.
 Broomfield CO, 80021
 Phone: (800) 976-9819
 www.viega.us

2.2 Material

- A. Tubing Standard: Viega PureFlow PEX high-density cross-linked polyethylene tubing shall be manufactured to the requirements of ASTM F876 and meet the standard grade hydrostatic pressure ratings from Plastic Pipe Institute in accordance with TR-4/03. The following three standard grade ratings are required:
 - 200 degrees F (93 degrees C) at 80 psig (551 kPa)
 - 180 degrees F (82 degrees C) at 100 psig (689 kPa)
 - 73.4 degrees F (23 degrees C) at 160 psig (1102 kPa)
 1. Chlorine testing: According to ASTM F876 shall meet or exceed the following end use condition.
 - a. End use conditions of : 100% @ 140°F. Per PEX 5306 (CL5).
 2. UV testing: According to ASTM F876 PEX tubing products shall meet or exceed the following exposure limits.
 - a. Viega PureFlow PEX 6 months.
- B. Tubing Standard: FostaPEX high-density cross-linked polyethylene tubing shall be manufactured to the requirements of ASTM F876 and meet the standard grade hydrostatic pressure ratings from Plastic Pipe Institute in accordance with TR-4/03. The following three standard grade ratings are required:
 - 200 degrees F (93 degrees C) at 80 psig (551 kPa)
 - 180 degrees F (82 degrees C) at 100 psig (689 kPa)
 - 73.4 degrees F (23 degrees C) at 160 psig (1102 kPa)
 1. Chlorine testing: According to ASTM F876 shall meet or exceed the following end use condition.
 - a. End use conditions of : 100% @ 140°F. Per PEX 5306 (CL5).
 2. UV testing: According to ASTM F876, PEX tubing products shall meet or exceed the following exposure limits:
 - a. FostaPEX 12 months.

- C. Fitting Standard: PureFlow Press fittings shall be manufactured from UNS, C87700, C87710 Bronze or Radel R[®] polymer, meeting the requirements of ASTM F877 and ASTM F3347 (metallic) or ASTM F3348 (polymer) tested as a system with Viega PureFlow PEX tubing. The PureFlow Press sleeve shall be manufactured out of a 304 grade or better stainless steel and have three view holes (attached sleeve) to ensure proper PEX tubing insertion. The attached sleeve fitting will incorporate a tool locator ring that shall be in place while making a proper press connection. The PureFlow Press connection shall be made with a Viega supplied ratcheting PureFlow Press hand tool or PureFlow Press power tool.
- D. Fitting Standard: PureFlow Crimp fittings for use with copper crimp rings shall be manufactured from UNS C69300 or C87850 Brass / Eco Brass[®] meeting the requirements of ASTM F1807 and or PolyAlloy polymer meeting the requirements of ASTM F2159. The PureFlow Crimp connection shall be made by use of a full circle crimp tool designed to crimp F1807 copper crimp rings.
- E. Manifolds: Acceptable manifolds shall include:
 - Copper Manifolds: Shall be copper material having a male or female solder, ProPress or PureFlow Crimp inlets. All outlets shall be PureFlow Press, PureFlow Crimp or ProPress fittings. Shall be provided by the Cross-linked Polyethylene system manufacturer.
 - Polymer Manifolds: Shall be plastic material having a male NPSM thread, PureFlow Press or PureFlow Crimp inlets. All outlets shall be PureFlow Press or PureFlow Crimp connections provided by the PEX system manufacturer.
- F. Adapter Fittings: PEX adapter fittings shall conform to one of the following ASTM standards; F877, F1807, F2159, or ASME B1.20.1 and be listed to the CSA B137.5. The adapter fittings shall mate to NPT threads, copper tubing, copper fittings or ProPress fittings.

2.3 Source Quality Control

- A. The PEX tubing and fitting manufacturer shall maintain a third party listing of the tubing and fittings. The tubing and fittings shall be certified in accordance with ANSI/NSF 14/61 to verify suitability to transport potable water. The tubing and fittings shall have the mark “NSF-pw”, “cNSF[®] us pw-G”, or “NSF 61” permanently marked on the product to verify the material listing.
- B. The manufacturer of the PEX tubing and fittings shall maintain a quality control program in accordance with ISO 9001 or NSF International in the manufacturing plant to assure that the tubing and fittings are continually being produced to the required standard. The tubing and fittings shall be certified as complying with NSF 14.

Part 3: Execution

3.1 Examination

The installing contractor shall carefully examine the PEX tubing for defects, cuts, abrasions, cracks, fading color, or blemishes. There shall be no cracks or heavy deformations of the tubing. Fittings and manifolds shall be checked for any signs of abuse. Any damaged tubing or fittings shall be rejected.

3.2 Preparation

- A. Viega PureFlow PEX tubing: Cross-linked polyethylene tubing shall be cut with a PEX tubing cutter. The tubing shall be cut squarely and neatly to permit a proper connection between the tubing and fitting.
- B. FostaPEX tubing: Cross-linked polyethylene tubing shall be cut with a PEX cutter. The tubing shall be cut squarely and neatly to permit a proper connection between the tubing and fitting. The outer polyethylene and aluminum layers shall be removed with a Viega supplied prep tool leaving the inner PEX tubing to accept the PureFlow Press fitting and stainless press sleeve. The prep tool shall have an internal stop to ensure proper length of exposed inner PEX tubing.

3.3 Installation General Locations

Plans indicate general location and arrangement of PEX system. Identified locations and arrangements are used to size pipe and calculate friction and loss and other design considerations. Install PEX tubing as indicated, except where deviations to layout are approved on coordination drawings.

3.4 Installation, PEX Tubing

- A. Pressure rating: Install components having a pressure rating equal to or greater than the system operating pressure.
- B. Install PEX tubing that is free of blemishes, cuts, gouges, kinks or noticeable fading of color.
- C. Changes in direction: PEX tubing shall not exceed an eight times the tubing outside diameter (OD) free bend radius or a five times the tubing OD supported bend radius, with use of a Viega approved bend support. Install fittings for changes in direction where any minimum bend radius is exceeded and branch connections.
- D. PureFlow Press connections: PureFlow Press fittings shall be made in accordance with the manufacturer's installation instructions. The Stainless press sleeve shall be placed over the end of the squared off PureFlow PEX tubing while fully inserting the fitting barb into the tubing. Full tubing insertion shall be verified by a visual confirmation of PEX being present through the view holes before engaging a press connection. Full insertion for an attached sleeve connection means tubing must be completely visible in at least two view holes and partially visible in the final view hole. The PureFlow Press connection shall be made with a Viega supplied ratcheting PureFlow Press hand tool or PureFlow Press power tool.
- E. PureFlow Crimp connections: PureFlow Crimp fittings shall be made in accordance with the manufacturer's installation instructions. The copper crimp ring shall be placed over the end of the squared off PEX tubing then the PureFlow Crimp fitting fully inserted into the tubing. Position the crimp ring $\frac{1}{8}$ " to $\frac{1}{4}$ " from the end of the tubing before engaging a crimp connection. The PureFlow Crimp connection shall be made with a Viega supplied full circle crimp tool or equivalent.
- F. Threaded joints: Threaded joints shall have a potable water listed joint sealant tape applied to the male threads only. Tighten joint with a wrench and backup wrench as required.
- G. PEX tubing protection: Protect PEX tubing from exposure to direct and indirect sunlight exposure. PEX tubing shall be stored under cover, shielded from direct and indirect sunlight when material is stored for any length of time.
- H. Penetration protection: Provide allowance for thermal expansion and contraction of PEX tubing passing through a wall, floor, ceiling or partition by wrapping with pipe insulation, or by installing through an appropriately sized sleeve. Penetrations of fire resistance rated assemblies shall maintain the rating of the assembly.
- I. Backfill material: Back fill material must be free of large rocks, glass, or other sharp objects which can damage the PEX tubing.
- J. Horizontal support: PEX tubing must be supported every 32" horizontally with Viega approved suspension clips or plastic insulators.
- K. Vertical support: PEX tubing must be supported at each floor or ceiling penetration and every four feet in between.

4 Dimensional Documents

PureFlow Crimp Fittings

Viega PureFlow Crimp 90° Elbow Zero Lead Brass - Model V5016ZL

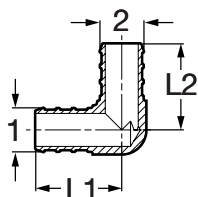

| Part No. | Size (in) | | L1 (in) | L2 (in) |
|----------|-----------|-----|---------|---------|
| | 1 | 2 | | |
| 46922 | 3/8 | 3/8 | 0.89 | 0.87 |
| 46933 | 1/2 | 1/2 | 0.95 | 0.87 |
| 46243 | 3/4 | 1/2 | 1.06 | 1.01 |
| 46944 | 3/4 | 3/4 | 1.06 | 1.00 |
| 46955 | 1 | 1 | 1.36 | 1.36 |

Viega PureFlow Crimp 90° Elbow Zero Lead Brass Crimp x MPT - Model V5014ZL

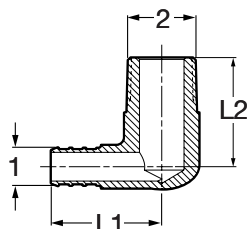

| Part No. | Size (in) | | L1 (in) | L2 (in) |
|----------|-----------|---------|---------|---------|
| | 1 | 2 | | |
| 46822 | 3/8 | 3/8 MPT | 1.03 | 0.96 |
| 46232 | 1/2 | 3/8 MPT | 1.29 | 0.96 |
| 46821 | 1/2 | 1/2 MPT | 1.11 | 1.19 |
| 46245 | 3/4 | 3/4 MPT | 1.50 | 1.26 |

Viega PureFlow Crimp 90° Elbow Drop Ear Zero Lead Brass Crimp x FPT - Model V5027ZL

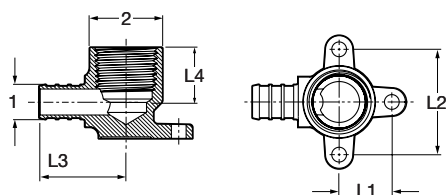

| Part No. | Size (in) | | L1 (in) | L2 (in) | L3 (in) | L4 (in) |
|----------|-----------|---------|---------|---------|---------|---------|
| | 1 | 2 | | | | |
| 46233 | 1/2 | 1/2 FPT | 0.79 | 1.58 | 1.39 | 0.72 |
| 46244 | 3/4 | 3/4 FPT | 0.99 | 1.98 | 1.46 | 1.05 |

Viega PureFlow Compression 90° Elbow For Dishwasher Zero Lead Copper CTS x Hose - Model V5053

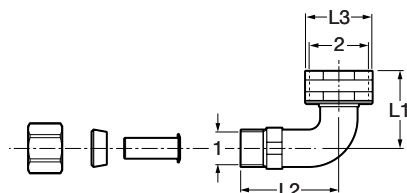

| Part No. | Size (in) | | L1 (in) | L2 (in) | L3 (in) |
|----------|-----------|--------------------------------|---------|---------|---------|
| | 1 | 2 | | | |
| 46743 | 3/8 | CTS (1/2 O.D.) Comp x 3/4 Hose | 1.32 | 1.67 | 1.14 |

Viega PureFlow Crimp 90° Elbow Zero Lead Copper Crimp x C - Model V5021

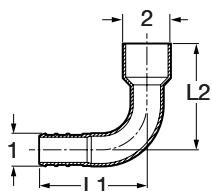

| Part No. | Size (in) | | L1 (in) | L2 (in) |
|----------|-----------|-------|---------|---------|
| | 1 | 2 | | |
| 44305 | 3/8 | 1/2 C | 1.68 | 1.46 |
| 44325 | 1/2 | 1/2 C | 1.43 | 1.58 |
| 44345 | 3/4 | 3/4 C | 2.05 | 2.01 |

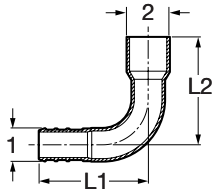
Viega PureFlow Crimp 90° Elbow Zero Lead Copper Crimp x FTG - Model V5020

| Part No. | Size (in) | L1 (in) | L2 (in) |
|----------|---------------|---------|---------|
| | 1 2 | | |
| 44302 | 3/8 x 1/2 FTG | 1.65 | 1.56 |
| 44320 | 1/2 x 1/2 FTG | 1.44 | 1.49 |
| 44340 | 3/4 x 3/4 FTG | 1.94 | 1.87 |

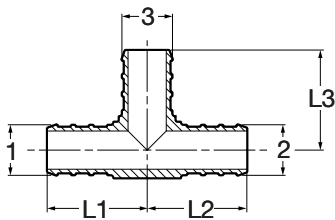
Viega PureFlow Crimp Tee Zero Lead Brass - Model V5018ZL

| Part No. | Size (in) | L1 (in) | L2 (in) | L3 (in) |
|----------|-----------------|---------|---------|---------|
| | 1 2 3 | | | |
| 46500 | 3/8 x 3/8 x 3/8 | 0.89 | 0.89 | 0.88 |
| 46520 | 1/2 x 1/2 x 1/2 | 0.95 | 0.95 | 0.88 |
| 46524 | 1/2 x 1/2 x 3/4 | 1.07 | 1.07 | 1.01 |
| 46540 | 3/4 x 3/4 x 3/4 | 1.07 | 1.07 | 1.00 |
| 46433 | 3/4 x 1/2 x 1/2 | 1.20 | 1.20 | 1.10 |
| 46435 | 3/4 x 1/2 x 3/4 | 1.07 | 1.12 | 1.01 |
| 46443 | 3/4 x 3/4 x 1/2 | 1.07 | 1.07 | 1.01 |
| 46445 | 3/4 x 3/4 x 1 | 1.21 | 1.21 | 1.25 |
| 46544 | 3/4 x 1 x 3/4 | 1.20 | 1.39 | 1.10 |
| 46545 | 3/4 x 1 x 1 | 1.21 | 1.39 | 1.28 |
| 46553 | 1 x 1 x 1/2 | 1.39 | 1.39 | 1.10 |
| 46554 | 1 x 1 x 3/4 | 1.39 | 1.39 | 1.10 |
| 46560 | 1 x 1 x 1 | 1.36 | 1.36 | 1.36 |

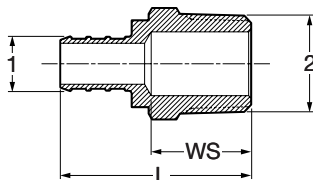
Viega PureFlow Crimp Adapter Zero Lead Brass Crimp x MPT - Model V5011ZL

| Part No. | Size (in) | L (in) | WS (in) |
|----------|---------------|--------|---------|
| | 1 2 | | |
| 46302 | 3/8 x 1/2 MPT | 1.63 | 0.88 |
| 46321 | 1/2 x 1/2 MPT | 1.65 | 0.88 |
| 46324 | 1/2 x 3/4 MPT | 1.84 | 1.06 |
| 46342 | 3/4 x 1/2 MPT | 1.68 | 0.88 |
| 46340 | 3/4 x 3/4 MPT | 1.84 | 1.06 |
| 46446 | 3/4 x 1 MPT | 2.07 | 1.38 |
| 46361 | 1 x 3/4 MPT | 2.02 | 1.06 |
| 46366 | 1 x 1 MPT | 2.25 | 1.38 |

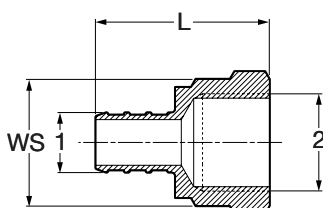
Viega PureFlow Crimp Adapter Zero Lead Brass Crimp x FPT - Model V5012ZL

| Part No. | Size (in) | L (in) | WS (in) |
|----------|---------------|--------|---------|
| | 1 2 | | |
| 46323 | 3/8 x 1/2 FPT | 1.62 | 1.00 |
| 46333 | 1/2 x 1/2 FPT | 1.62 | 1.00 |
| 46334 | 1/2 x 3/4 FPT | 1.67 | 1.25 |
| 46344 | 3/4 x 3/4 FPT | 1.67 | 1.25 |
| 46345 | 3/4 x 1 FPT | 1.89 | 1.50 |
| 46355 | 1 x 1 FPT | 2.07 | 1.50 |

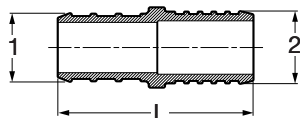
Viega PureFlow Crimp Adapter Zero Lead Brass Crimp x PB - Model V5017ZL

| Part No. | Size (in) | | L (in) |
|----------|---------------|-------------------------|--------|
| | 1 | 2 | |
| 46620 | $\frac{3}{8}$ | $\times \frac{3}{8}$ PB | 1.37 |
| 46630 | $\frac{1}{2}$ | $\times \frac{1}{2}$ PB | 1.37 |
| 46145 | $\frac{3}{4}$ | $\times \frac{3}{4}$ PB | 1.94 |
| 46156 | 1 | $\times 1$ PB | 2.39 |

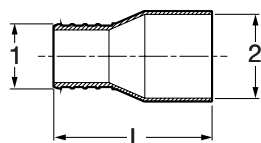
Viega PureFlow Crimp Adapter Zero Lead Brass Crimp x C - Model V5045ZL

| Part No. | Size (in) | | L (in) |
|----------|---------------|------------------------|--------|
| | 1 | 2 | |
| 46635 | $\frac{1}{2}$ | $\times \frac{1}{2}$ C | 1.33 |
| 46645 | $\frac{3}{4}$ | $\times \frac{3}{4}$ C | 1.57 |
| 40655 | 1 | $\times 1$ C | 2.13 |

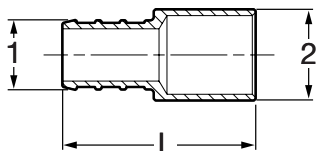
Viega PureFlow Crimp Adapter Zero Lead Brass Crimp x FTG - Model V5046ZL

| Part No. | Size (in) | | L (in) |
|----------|---------------|--------------------------|--------|
| | 1 | 2 | |
| 46633 | $\frac{1}{2}$ | $\times \frac{1}{2}$ FTG | 1.33 |
| 46644 | $\frac{3}{4}$ | $\times \frac{3}{4}$ FTG | 1.50 |
| 60651 | 1 | $\times 1$ FTG | 1.97 |

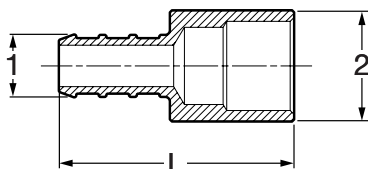
Viega PureFlow Crimp Adapter Zero Lead Brass Crimp x FTG x C - Model V5024ZL

| Part No. | Size (in) | | L (in) |
|----------|---------------|---|--------|
| | 1 | 2 | |
| 46621 | $\frac{3}{8}$ | $\times \frac{3}{8}$ FTG or $\frac{1}{4}$ C | 1.33 |
| 46622 | $\frac{3}{8}$ | $\times \frac{1}{2}$ FTG or $\frac{3}{8}$ C | 1.33 |
| 46631 | $\frac{1}{2}$ | $\times \frac{3}{8}$ FTG or $\frac{1}{4}$ C | 1.46 |
| 46654 | 1 | $\times 1$ FTG or $\frac{3}{4}$ C | 1.92 |

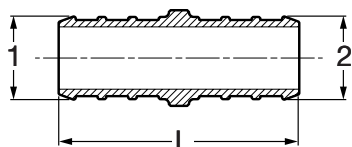
Viega PureFlow Crimp Coupling Zero Lead Brass - Model V5015ZL

| Part No. | Size (in) | | L (in) |
|----------|---------------|----------------------|--------|
| | 1 | 2 | |
| 46422 | $\frac{3}{8}$ | | 1.39 |
| 46432 | $\frac{1}{2}$ | $\times \frac{3}{8}$ | 1.39 |
| 46434 | $\frac{1}{2}$ | | 1.39 |
| 46441 | $\frac{3}{4}$ | $\times \frac{1}{2}$ | 1.39 |
| 46444 | $\frac{3}{4}$ | | 1.39 |
| 46454 | 1 | $\times \frac{3}{4}$ | 1.57 |
| 46455 | 1 | | 1.75 |

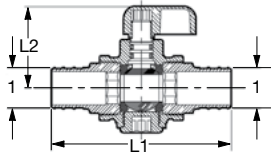
Viega PureFlow Crimp Ball Valve Zero Lead Brass ¼ Turn - Model V5037ZL

| Part No. | Size (in) 1 1 | L1 (in) | L2 (in) |
|----------|------------------|---------|---------|
| 46010 | ¾ x ¾ | 3.09 | 1.20 |
| 46031 | ½ x ½ | 2.76 | 1.20 |
| 46044 | ¾ x ¾ | 2.95 | 1.30 |

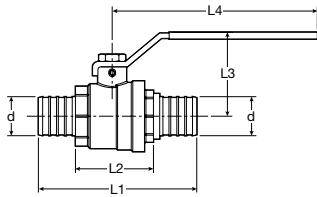
Viega PureFlow Crimp Ball Valve Zero Lead Brass ¼ Turn - Model V5037ZL

| Part No. | Size (in) 1 1 | L1 (in) | L2 (in) | L3 (in) | L4 (in) |
|----------|------------------|---------|---------|---------|---------|
| 46060 | 1 x 1 | 3.41 | 1.71 | 1.84 | 4.50 |

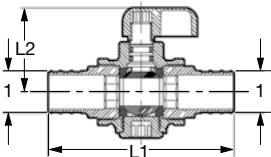
Viega PureFlow Crimp Ball Valve Zero Lead Chrome Plated Brass ¼ Turn - Model V5023ZL

| Part No. | Size (in) 1 | L1 (in) | L2 (in) |
|----------|----------------|---------|---------|
| 46021 | ½ | 2.76 | 1.20 |

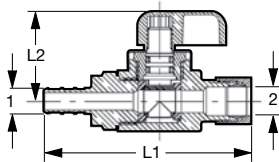
Viega PureFlow Crimp Stop Valve Straight Zero Lead Chrome Plated Brass Crimp x CTS ¼ Turn - Model V5026ZL

| Part No. | Size (in) 1 2 | L1 (in) | L2 (in) |
|----------|-----------------------|---------|---------|
| 46001 | ¾ x ¼ CTS (¾ OD) Comp | 2.78 | 1.20 |
| 46022 | ½ x ¼ CTS (¾ OD) Comp | 2.78 | 1.20 |

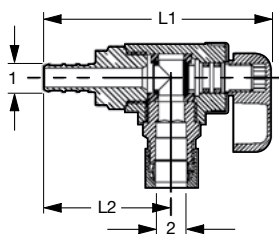
Viega PureFlow Crimp Stop Valve Angled Zero Lead Chrome Plated Brass Crimp x CTS ¼ Turn - Model V5064ZL

| Part No. | Size (in) 1 2 | L1 (in) | L2 (in) |
|----------|-----------------------|---------|---------|
| 46002 | ¾ x ¼ CTS (¾ OD) Comp | 2.70 | 1.03 |
| 46025 | ½ x ¼ CTS (¾ OD) Comp | 2.80 | 1.03 |

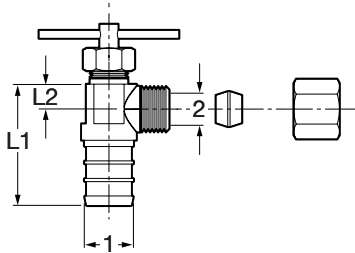
Viega PureFlow Crimp Adapter Straight Zero Lead Brass For Ice Maker Crimp x CTS - Model V5051ZL

| Part No. | Size (in) | L1 (in) | L2 (in) |
|----------|--|---------|---------|
| | 1 2 | | |
| 46301 | $\frac{3}{8}$ x $\frac{1}{8}$ CTS ($\frac{1}{4}$ OD) Comp | 1.48 | 0.55 |
| 46322 | $\frac{1}{2}$ x $\frac{1}{8}$ CTS ($\frac{1}{4}$ OD) Comp | 1.48 | 0.55 |

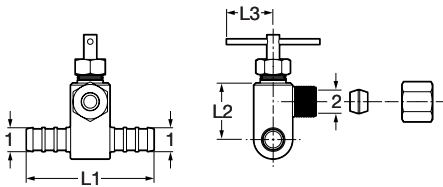
Viega PureFlow Crimp Tee Zero Lead Brass For Ice Maker Crimp x Crimp x CTS - Model V5062ZL

| Part No. | Size (in) | L1 (in) | L2 (in) | L3 (in) |
|----------|--|---------|---------|---------|
| | 1 2 | | | |
| 46503 | $\frac{3}{8}$ x $\frac{1}{8}$ CTS ($\frac{1}{4}$ OD) Comp | 1.83 | 1.03 | 0.59 |
| 46521 | $\frac{1}{2}$ x $\frac{1}{8}$ CTS ($\frac{1}{4}$ OD) Comp | 1.83 | 1.03 | 0.59 |

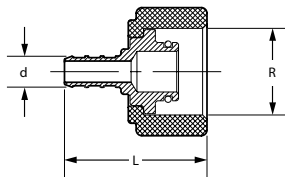
Viega PureFlow Crimp Port Adapter Zero Lead Brass For ManaBloc Crimp x Port - Model V5039ZL

| Part No. | Size (in) | L (in) |
|----------|------------------------------------|--------|
| | 1 2 | |
| 46624 | $\frac{3}{8}$ x $\frac{1}{2}$ Port | 1.58 |
| 46634 | $\frac{1}{2}$ x $\frac{1}{2}$ Port | 1.58 |

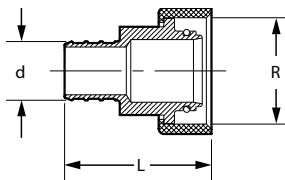
Viega PureFlow Crimp Supply Adapter Zero Lead Brass For ManaBloc Crimp x Supply - Model V5034ZL

| Part No. | Size (in) | L (in) |
|----------|----------------------------|--------|
| | 1 2 | |
| 46414 | $\frac{3}{4}$ x 1 ManaBloc | 1.66 |
| 46416 | 1 x 1 ManaBloc | 1.84 |

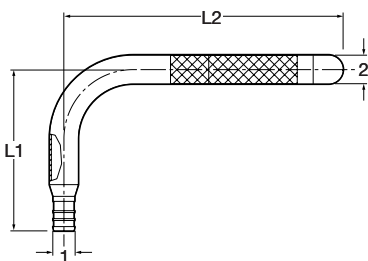
Viega PureFlow Crimp Stub-Out 90° Elbow Zero Lead Copper Crimp x Street - Model V5070

| Part No. | Size (in) | L1 (in) | L2 (in) |
|----------|-----------------------------------|---------|---------|
| | 1 2 | | |
| 44208 | $\frac{3}{8}$ x $\frac{1}{2}$ FTG | 3.50 | 7.75 |
| 44226 | $\frac{1}{2}$ x $\frac{1}{2}$ FTG | 3.50 | 5.75 |
| 44228 | $\frac{1}{2}$ x $\frac{1}{2}$ FTG | 3.50 | 7.75 |
| 44240 | $\frac{3}{4}$ x $\frac{3}{4}$ FTG | 4.50 | 8.00 |

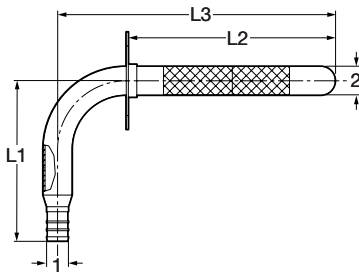
Viega PureFlow Crimp Stub-Out 90° Elbow Zero Lead Copper Crimp x Street with Wall Plate - Model V5070.1

| Part No. | Size (in) | L1 (in) | L2 (in) | L3 (in) |
|----------|-----------------------------------|---------|---------|---------|
| | 1 2 | | | |
| 44209 | $\frac{3}{8}$ x $\frac{1}{2}$ FTG | 3.50 | 7.75 | 6.00 |
| 44227 | $\frac{1}{2}$ x $\frac{1}{2}$ FTG | 3.50 | 5.75 | 4.00 |
| 44229 | $\frac{1}{2}$ x $\frac{1}{2}$ FTG | 3.50 | 7.75 | 6.00 |

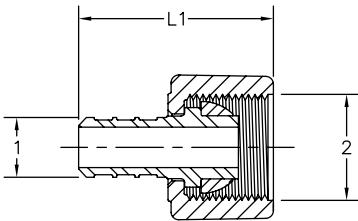
Viega PureFlow Crimp Lav Adapter Zero Lead Brass Crimp x Lav - Model V5075ZL

| Part No. | Size (in) | L (in) |
|----------|---|--------|
| | 1 2 | |
| 46023 | $\frac{3}{8}$ x $\frac{1}{2}$ Lav (plastic nut) | 1.65 |
| 46033 | $\frac{1}{2}$ x $\frac{1}{2}$ Lav (plastic nut) | 1.65 |
| 46024 | $\frac{3}{8}$ x $\frac{1}{2}$ Lav (brass nut) | 1.65 |
| 46034 | $\frac{1}{2}$ x $\frac{1}{2}$ Lav (brass nut) | 1.65 |
| 46040 | $\frac{3}{4}$ x $\frac{3}{4}$ Lav (brass nut) | 1.70 |

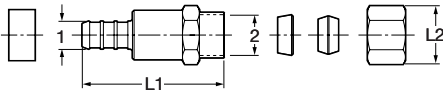
Viega PureFlow Crimp Lav Adapter Zero Lead Brass Crimp x CTS - Model V5077ZL

| Part No. | Size (in) | L1 (in) | L2 (in) |
|----------|--|---------|---------|
| | 1 2 | | |
| 46032 | $\frac{3}{8}$ x $\frac{1}{4}$ CTS ($\frac{3}{8}$ OD) Comp | 1.76 | 0.63 |
| 46331 | $\frac{1}{2}$ x $\frac{1}{4}$ CTS ($\frac{3}{8}$ OD) Comp | 1.76 | 0.63 |

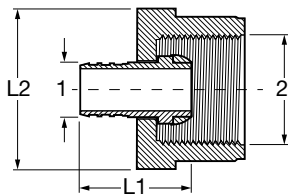
Viega PureFlow Crimp Closet Adapter Zero Lead Brass Crimp x Closet - Model V5072ZL

| Part No. | Size (in) | L1 (in) | L2 (in) |
|----------|--|---------|---------|
| | 1 2 | | |
| 46223 | $\frac{3}{8}$ x $\frac{1}{2}$ Closet (plastic nut) | 1.36 | 1.16 |
| 46234 | $\frac{1}{2}$ x $\frac{1}{2}$ Closet (plastic nut) | 1.36 | 1.16 |

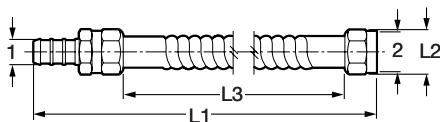
Viega PureFlow Crimp Swivel Connector Zero Lead Copper For Water Heater Crimp x FPT - Model V5048ZL

| Part No. | Size (in) | L1 (in) | L2 (in) | L3 (in) |
|----------|-----------------------------------|---------|---------|---------|
| | 1 2 | | | |
| 46764 | $\frac{3}{4}$ x $\frac{3}{4}$ FPT | 19.00 | 1.13 | 18.00 |

Viega PureFlow Crimp Outlet Box Zero Lead Brass For Ice Maker ¼ Turn - Model 2872ZL

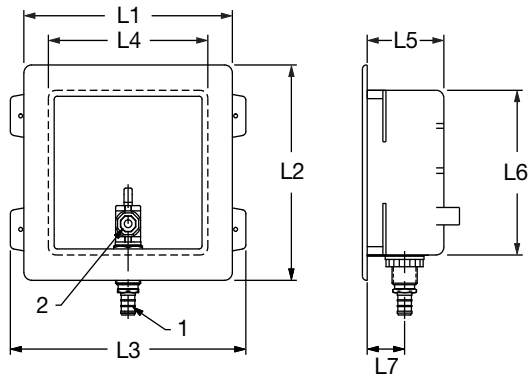

| Part No. | Size (in) | L1 (in) | L2 (in) | L3 (in) | L4 (in) | L5 (in) | L6 (in) | L7 (in) |
|----------|--------------------------|---------|---------|---------|---------|---------|---------|---------|
| | 1 2 | | | | | | | |
| 46710* | 3/8 x 1/8 CTS (1/4 O.D.) | 6.80 | 6.80 | 7.68 | 5.20 | 2.50 | 5.20 | 1.22 |
| 46720* | 1/2 x 1/8 CTS (1/4 O.D.) | 6.80 | 6.80 | 7.68 | 5.20 | 2.50 | 5.20 | 1.22 |
| 43700 | 3/8 x 1/8 CTS (1/4 O.D.) | 6.80 | 6.80 | 7.68 | 5.20 | 2.50 | 5.20 | 1.22 |
| 43722 | 1/2 x 1/8 CTS (1/4 O.D.) | 6.80 | 6.80 | 7.68 | 5.20 | 2.50 | 5.20 | 1.22 |

* with hammer arrestor

Viega PureFlow Crimp Outlet Box Zero Lead Brass For Washing Machine ¼ Turn - Model 2872.9ZL

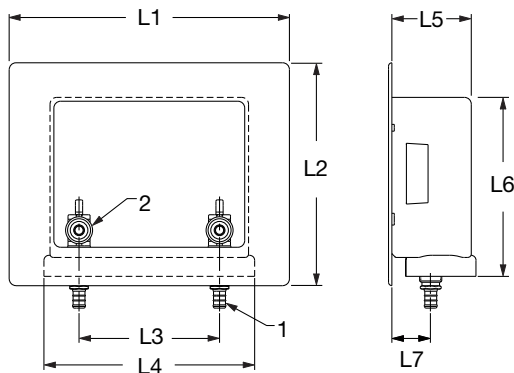

| Part No. | Size (in) | L1 (in) | L2 (in) | L3 (in) | L4 (in) | L5 (in) | L6 (in) | L7 (in) |
|----------|----------------|---------|---------|---------|---------|---------|---------|---------|
| | 1 2 | | | | | | | |
| 46730* | 1/2 x 3/4 Hose | 10.40 | 8.30 | 5.20 | 7.40 | 2.90 | 6.60 | 1.43 |
| 43720 | 1/2 x 3/4 Hose | 10.40 | 8.30 | 5.20 | 7.40 | 2.90 | 6.60 | 1.43 |

* with hammer arrestor

Viega PureFlow Crimp Ring Copper - Model V5019.9

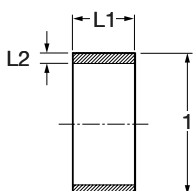

| Part No. | Size (in) | L1 (in) | L2 (in) |
|----------|-----------|---------|---------|
| | 1 | | |
| 43600 | 3/8 | 0.32 | 0.05 |
| 43620 | 1/2 | 0.32 | 0.05 |
| 43640 | 3/4 | 0.32 | 0.05 |
| 43660 | 1 | 0.36 | 0.04 |

Dimensional Documents

PureFlow Crimp PolyAlloy Fittings

Viega PureFlow Crimp 90° Elbow Zero Lead PolyAlloy - Model V5216

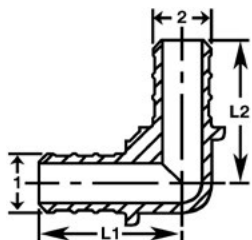

| Part No. | Size (in) | L1 (in) | L2 (in) |
|----------|----------------------------------|---------|---------|
| | 1 2 | | |
| 43210 | $\frac{3}{8} \times \frac{3}{8}$ | 1.15 | 1.15 |
| 43220 | $\frac{1}{2} \times \frac{1}{2}$ | 1.15 | 1.15 |
| 43240 | $\frac{3}{4} \times \frac{3}{4}$ | 1.25 | 1.25 |
| 43242 | $\frac{3}{4} \times \frac{1}{2}$ | 1.25 | 1.25 |
| 43260 | 1 x 1 | 1.53 | 1.53 |

Viega PureFlow Crimp Tee Zero Lead PolyAlloy - Model V5218

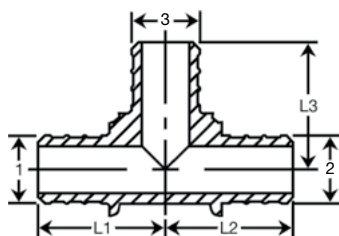

| Part No. | Size (in) | L1 (in) | L2 (in) | L3 (in) |
|----------|---|---------|---------|---------|
| | 1 2 3 | | | |
| 43500 | $\frac{3}{8} \times \frac{3}{8} \times \frac{3}{8}$ | 1.16 | 1.16 | 1.16 |
| 43520 | $\frac{1}{2} \times \frac{1}{2} \times \frac{1}{2}$ | 1.15 | 1.15 | 1.15 |
| 43334 | $\frac{1}{2} \times \frac{1}{2} \times \frac{3}{4}$ | 1.25 | 1.25 | 1.15 |
| 43540 | $\frac{3}{4} \times \frac{3}{4} \times \frac{3}{4}$ | 1.25 | 1.25 | 1.25 |
| 43433 | $\frac{3}{4} \times \frac{1}{2} \times \frac{1}{2}$ | 1.25 | 1.15 | 1.25 |
| 43434 | $\frac{3}{4} \times \frac{1}{2} \times \frac{3}{4}$ | 1.25 | 1.25 | 1.25 |
| 43443 | $\frac{3}{4} \times \frac{3}{4} \times \frac{1}{2}$ | 1.15 | 1.15 | 1.25 |
| 43445 | $\frac{3}{4} \times \frac{3}{4} \times 1$ | 1.30 | 1.30 | 1.34 |
| 43544 | 1 x $\frac{3}{4}$ x $\frac{3}{4}$ | 1.37 | 1.36 | 1.36 |
| 43545 | 1 x $\frac{3}{4}$ x 1 | 1.54 | 1.39 | 1.54 |
| 43553 | 1 x 1 x $\frac{1}{2}$ | 1.33 | 1.33 | 1.32 |
| 43554 | 1 x 1 x $\frac{3}{4}$ | 1.33 | 1.33 | 1.26 |
| 43560 | 1 x 1 x 1 | 1.53 | 1.53 | 1.53 |

Viega PureFlow Crimp Zero Lead Coupling PolyAlloy - Model V5215

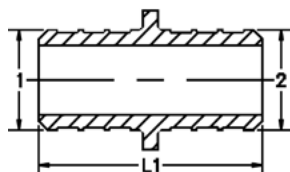

| Part No. | Size (in) | L (in) |
|----------|----------------------------------|--------|
| | 1 2 | |
| 43402 | $\frac{3}{8} \times \frac{3}{8}$ | 1.52 |
| 43403 | $\frac{1}{2} \times \frac{1}{2}$ | 1.50 |
| 43332 | $\frac{1}{2} \times \frac{3}{8}$ | 1.52 |
| 43343 | $\frac{3}{4} \times \frac{1}{2}$ | 1.50 |
| 43353 | 1 x $\frac{1}{2}$ | 1.70 |
| 43404 | $\frac{3}{4} \times \frac{3}{4}$ | 1.50 |
| 43354 | 1 x $\frac{3}{4}$ | 1.70 |
| 43355 | 1 x 1 | 1.82 |

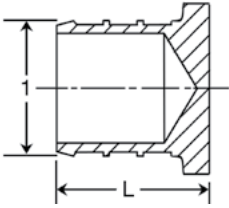
Viega PureFlow Crimp Test Plug Zero Lead PolyAlloy - Model V5058

| Part No. | Size (in) | L (in) |
|----------|---------------|--------|
| | 1 | |
| 43702 | $\frac{3}{8}$ | 0.76 |
| 43723 | $\frac{1}{2}$ | 0.76 |
| 43744 | $\frac{3}{4}$ | 0.95 |
| 43765 | 1 | 1.13 |

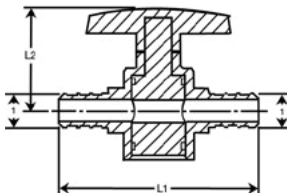
Viega PureFlow Crimp Valve Zero Lead PolyAlloy $\frac{1}{4}$ Turn - Model V5236

| Part No. | Size (in) | L1 (in) | L2 (in) |
|----------|---------------|---------|---------|
| | 1 | | |
| 43030 | $\frac{1}{2}$ | 2.83 | 1.45 |
| 43040 | $\frac{3}{4}$ | 3.00 | 1.45 |

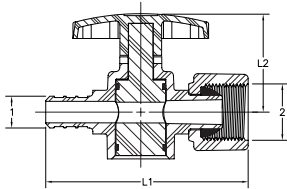
Viega PureFlow Crimp Stop Valve Straight Zero Lead PolyAlloy Crimp x Lav $\frac{1}{4}$ Turn - Model V5036.30

| Part No. | Size (in) | L1 (in) | L2 (in) |
|----------|-----------------------------------|---------|---------|
| | 1 2 | | |
| 43023 | $\frac{3}{8}$ x $\frac{1}{2}$ Lav | 3.00 | 1.45 |

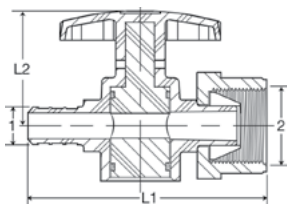
Viega PureFlow Crimp Stop Valve Straight Zero Lead PolyAlloy Crimp x Closet $\frac{1}{4}$ Turn - Model V5036.31

| Part No. | Size (in) | L1 (in) | L2 (in) |
|----------|--------------------------------------|---------|---------|
| | 1 2 | | |
| 43002 | $\frac{3}{8}$ x $\frac{1}{2}$ Closet | 3.00 | 1.45 |
| 43003 | $\frac{1}{2}$ x $\frac{1}{2}$ Closet | 3.00 | 1.45 |

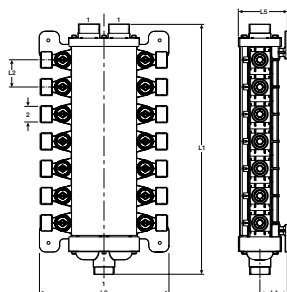
Viega ManaBloc Distribution Manifold Zero Lead Crimp - Model V5030.5

| Part No. | Size (in) | Ports | L1 (in) | L2 (in) | L3 (in) | L4 (in) | L5 (in) |
|----------|------------------------|-------|---------|---------|---------|---------|---------|
| | 1 2 | | | | | | |
| 50244 | 1 x $\frac{5}{8}$ NPSM | 12 | 13.76 | 1.68 | 8.00 | 1.70 | 3.00 |
| 50143 | 1 x $\frac{5}{8}$ NPSM | 14 | 15.44 | 1.68 | 8.00 | 1.70 | 3.00 |
| 51618 | 1 x $\frac{5}{8}$ NPSM | 18 | 18.80 | 1.68 | 8.00 | 1.70 | 3.00 |
| 50243 | 1 x $\frac{5}{8}$ NPSM | 24 | 23.78 | 1.68 | 8.00 | 1.70 | 3.00 |
| 50303 | 1 x $\frac{5}{8}$ NPSM | 30 | 28.88 | 1.68 | 8.00 | 1.70 | 3.00 |
| 50363 | 1 x $\frac{5}{8}$ NPSM | 36 | 33.92 | 1.68 | 8.00 | 1.70 | 3.00 |

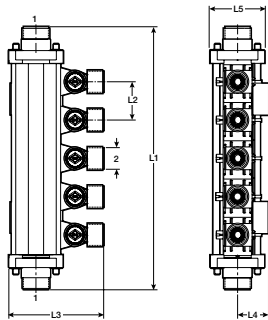
Viega MiniBloc Zoning Manifold Zero Lead Crimp - Model V5031.5

| Part No. | Size (in) | | Ports | L1 (in) | L2 (in) | L3 (in) | L4 (in) | L5 (in) |
|----------|-----------|------|-------|---------|---------|---------|---------|---------|
| | 1 | 2 | | | | | | |
| 50033 | 1 x 5/8 | NPSM | 3 | 8.19 | 1.68 | 4.37 | 1.42 | 2.50 |
| 50043 | 1 x 5/8 | NPSM | 4 | 9.87 | 1.68 | 4.37 | 1.42 | 2.50 |
| 51063* | 1 x 5/8 | NPSM | 5 | 11.55 | 1.68 | 4.37 | 1.42 | 2.50 |
| 50063 | 1 x 5/8 | NPSM | 6 | 13.23 | 1.68 | 4.37 | 1.42 | 2.50 |
| 51073* | 1 x 5/8 | NPSM | 7 | 14.91 | 1.68 | 4.37 | 1.42 | 2.50 |
| 50083 | 1 x 5/8 | NPSM | 8 | 16.59 | 1.68 | 4.37 | 1.42 | 2.50 |
| 51003* | 1 x 5/8 | NPSM | 10 | 19.95 | 1.68 | 4.37 | 1.42 | 2.50 |

* Manifold incorporates hot and cold ports.

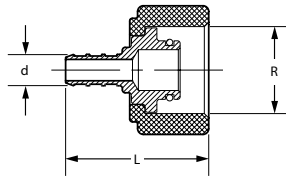
Viega PureFlow Crimp Port Adapter Zero Lead PolyAlloy for ManaBloc Crimp x Port - Model V5039.1

| Part No. | Size (in) | | L (in) |
|----------|-----------|------|--------|
| | 1 | 2 | |
| 50023 | 3/8 x 1/2 | Port | 1.58 |
| 50133 | 1/2 x 1/2 | Port | 1.58 |
| 51123 | 1/2 x 3/8 | Port | 1.58 |
| 51133 | 3/8 x 3/8 | Port | 1.58 |

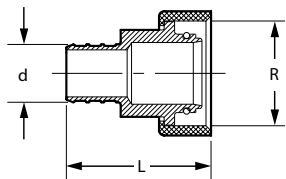
Viega PureFlow Crimp Supply Adapter Zero Lead PolyAlloy for ManaBloc Crimp x Supply - Model V5213

| Part No. | Size (in) | | L (in) |
|----------|-----------|----------|--------|
| | 1 | 2 | |
| 50141 | 3/4 x 1 | ManaBloc | 1.66 |
| 50151 | 1 x 1 | ManaBloc | 1.84 |

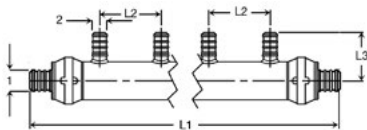
Viega PureFlow Crimp Manifold Zero Lead PolyAlloy Flow Through - Model V5031.2

| Part No. | Size (in) | | Outlets | L1 (in) | L2 (in) | L3 (in) |
|----------|-----------|-------|---------|---------|---------|---------|
| | 1 | 2 | | | | |
| 65152 | 3/4 x 1/2 | | 2 | 6.50 | 2.00 | 1.55 |
| 65153 | 3/4 x 1/2 | | 3 | 8.50 | 2.00 | 1.55 |
| 65154 | 3/4 x 1/2 | | 4 | 10.50 | 2.00 | 1.55 |
| 65254 | 1 x 3/4 | x 1/2 | 4 | 10.60 | 2.00 | 1.55 |
| 65256 | 1 x 1/2 | | 6 | 14.80 | 2.00 | 1.55 |
| 65258 | 1 x 1/2 | | 8 | 18.80 | 2.00 | 1.55 |

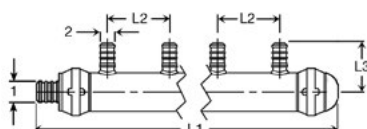
Viega PureFlow Crimp Manifold Zero Lead PolyAlloy Closed - Model V5031.22

| Part No. | Size (in) | | Outlets | L1 (in) | L2 (in) | L3 (in) |
|----------|-----------|---|---------|---------|---------|---------|
| | 1 | 2 | | | | |
| 65104 | 3/4 x 1/2 | | 4 | 10.10 | 2.00 | 1.55 |
| 65206 | 1 x 1/2 | | 6 | 14.30 | 2.00 | 1.55 |

Viega PureFlow Crimp Lav Adapter Zero Lead PolyAlloy Crimp x Lav - Model V5263

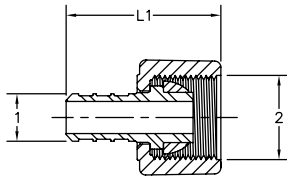

| Part No. | Size (in) | L1 (in) |
|----------|---------------|---------|
| | 1 2 | |
| 43323 | 3/8 x 1/2 Lav | 1.52 |
| 43333 | 1/2 x 1/2 Lav | 1.46 |
| 43344 | 3/4 x 3/4 Lav | 1.62 |

Viega PureFlow Crimp Lav Adapter 90° Elbow Zero Lead PolyAlloy Crimp x Lav - Model V5255

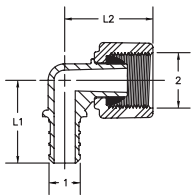

| Part No. | Size (in) | L1 (in) | L2 (in) |
|----------|---------------|---------|---------|
| | 1 2 | | |
| 43232 | 3/8 x 1/2 Lav | 1.35 | 1.15 |
| 43233 | 1/2 x 1/2 Lav | 1.35 | 1.15 |
| 43244 | 3/4 x 3/4 Lav | 1.42 | 1.25 |

Viega PureFlow Crimp Closet Adapter Zero Lead PolyAlloy Crimp x Closet - Model V5257

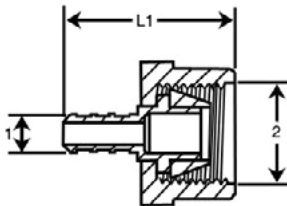

| Part No. | Size (in) | L1 (in) |
|----------|------------------|---------|
| | 1 2 | |
| 43300 | 3/8 x 1/2 Closet | 1.60 |
| 43320 | 1/2 x 1/2 Closet | 1.60 |

Viega PureFlow Crimp Ring Copper - Model V5019.9

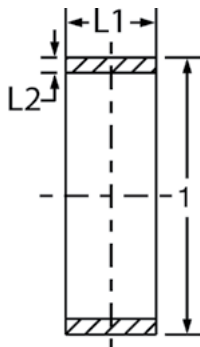

| Part No. | Size (in) | L1 (in) | L2 (in) |
|----------|-----------|---------|---------|
| | 1 2 | | |
| 43600 | 3/8 SDR9 | 0.32 | 0.05 |
| 43620 | 1/2 SDR9 | 0.32 | 0.05 |
| 43640 | 3/4 SDR9 | 0.32 | 0.05 |
| 43660 | 1 SDR9 | 0.36 | 0.04 |

5 Warranty

PureFlow Water System

Subject to the conditions and limitations in this Limited Warranty, VIEGA LLC (Viega) warrants to the owner of applicable real property in the United States (including its territories) and Canada that the components in its PureFlow Plumbing System (as described below) when properly installed by licensed plumbers in potable water systems, under normal conditions of use, shall be free from failure caused by manufacturing defects for a period of twenty-five (25) years from date of installation.

The Viega PureFlow Plumbing System and components covered by this twenty-five (25) year warranty are:

Viega PureFlow cross-linked polyethylene (PEX) tubing or PureFlow FostaPEX® tubing installed with PureFlow Press fittings in metal or polymer and PureFlow Press sleeves sold by Viega installed as a system.

Viega PureFlow cross-linked polyethylene (PEX) tubing and ASTM F1807 metal crimp insert fittings sold by Viega and ASTM F2159 PolyAlloy crimp fittings sold by Viega installed with copper crimp rings as a system.

Viega warrants that ManaBloc®, MiniBloc or polymer or metallic manifolds, and their approved connections, sold by Viega and installed as a manifold plumbing system under normal conditions of use, shall be free from failure caused by manufacturing defects for a period of ten (10) years from date of installation.

Power tools and jaws used with PureFlow Press fittings are warranted by the manufacturer and Viega extends no separate warranty on those tools or jaws. Viega warrants that PureFlow Press hand tools sold by Viega, under normal conditions of use, shall be free from failure caused by manufacturing defects for a period of two (2) years from date of sale. Viega warrants that PureFlow Crimp hand tools and tubing cutters sold by Viega, under normal conditions of use, shall be free from failure caused by manufacturing defects for a period of twelve (12) months from date of sale.

Viega warrants that properly installed PureFlow valves, PureFlow lav and closet risers and riser accessories manufactured and/or sold by Viega shall be free from failure caused by manufacturing defects for a period of two (2) years from date of installation.

Viega does not extend any warranty on its components used in systems with tubing, fittings, manifolds, or press sleeves not sold by Viega or installed by other than a licensed plumber. In addition, the warranty does not apply if distribution lines and their connections to manifold plumbing systems sold by Viega are not Viega Pureflow PEX or PureFlow FostaPEX tubing or approved connections sold by Viega.

Connection to non-Viega plumbing products intended for riser and/or water service applications does not void the system warranty provided all pipe, fittings, valves and manifolds are sold by Viega after the transition location.

Termination connections to non-Viega end-use devices or equipment such as filtration, water softeners, shower valves, faucets, stops and other such devices, when utilizing Viega PureFlow PEX and PureFlow FostaPEX does not void the system warranty as described.

Under this limited warranty, you only have a right to reimbursement if the failure or leak or resulting damage resulted from a manufacturing defect in the products covered by this warranty and the failure or leak or resulting damage occurred during the warranty period. You do not have a remedy or right of reimbursement under this warranty and the warranty does not apply if the failure or leak or resulting damage is

caused by (1) components in the plumbing system other than those manufactured or sold by Viega; (2) not designing, installing, inspecting, testing, or operating the system in accordance with Viega's installation instructions at the time of the installation, applicable code requirements and good plumbing practices; (3) improper handling and protection of the product prior to and during installation, exposure to ultra violet light, inadequate freeze protection, exposure to water pressures or temperatures in excess of the limitations on the tubing or application of unauthorized or harmful solvents or chemicals; (4) chemically corrosive or aggressive water conditions; or (5) acts of nature such as earthquakes, fire, flood or lightning.

In the event of a failure or leak in the system, it is the responsibility of the property owner to obtain and pay for repairs. Only if the warranty applies will Viega be responsible for reimbursement under this warranty. The part or parts which you claim failed should be kept and Viega contacted at the address below or by telephoning 800-976-9819 within thirty (30) days after the failure or leak and identifying yourself as having a warranty claim. You should be prepared to ship, at your expense, the product which you claim failed due to a manufacturing defect, document the date of installation, and the amount of any claimed bills for which you seek reimbursement. Within a reasonable time after receiving the product, Viega will investigate the reasons for the failure, which includes the right to inspect the product at Viega and reasonable access to the site of damage in order to determine whether the warranty applies. Viega will notify you of the results of this review.

In the event that Viega determines that the failure or leak and any resulting damages were the result of a manufacturing defect in the products covered by the 10-year or 25-year limited warranties and occurred during the first ten (10) years covered by this warranty, Viega will reimburse the property owner for reasonable repair or replacement charges to include drywall, flooring and painting costs, as well as damages to personal property, resulting from the failure or leak. The remaining 15-year limited warranty for products covered by the 25-year limited warranty will cover material costs for pipe and fittings only, sold by Viega, not inclusive of any labor or installation costs. Any change in property ownership after the first ten years will nullify any remaining warranty coverage.

VIEGA SHALL NOT BE LIABLE FOR CONSEQUENTIAL ECONOMIC LOSS DAMAGES UNDER ANY LEGAL THEORY AND WHETHER ASSERTED BY DIRECT ACTION, FOR CONTRIBUTION OR INDEMNITY OR OTHERWISE.

THE ABOVE LIMITED WARRANTY IS IN LIEU OF ALL OTHER WARRANTIES, EXPRESS OR IMPLIED, INCLUDING BUT NOT LIMITED TO, THE IMPLIED WARRANTIES OF MERCHANTABILITY AND FITNESS FOR A PARTICULAR PURPOSE. IF FOUND APPLICABLE, ANY IMPLIED WARRANTIES ARE LIMITED TO THE DURATION OF THE TIME LIMITS SET OUT IN THIS WRITTEN WARRANTY. Other than this limited warranty, Viega does not authorize any person or firm to create for it any other obligation or liability in connection with its products. This written warranty applies for the first 10 years of the applicable warranty regardless of any change of ownership in the property.

Some states do not allow the exclusion or limitation of incidental or consequential damages or limitations on the duration of implied warranties in certain types of transactions, so the above exclusion or limitations may not apply to you. This limited warranty gives you specific legal rights and you also may have other rights which vary from state to state. This warranty shall be interpreted and applied under the law of the state in which the product is installed.

V Viega LLC
585 Interlocken Blvd.
Broomfield, CO 80021

Phone (800) 976-9819
www.viega.us

SM-PF 0420 PureFlow Crimp Fittings

