

Models/Modelos/Modèles

P188201LF▲

P188501LF▲

Series/Series/Seria

RP79314▲

Handle w/Set Screw & Button
Manija con Tornillo de Ajuste y Botón
Manette avec Vis de Calage et Bouton

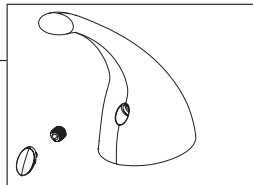

RP77763▲

Repair Kit
Equipo/Herramientas para reparaciones
Kit de réparation

6

RP70197▲-1.0

1.0 GPM (3.8 L/min)

RP70197▲

1.5 GPM (5.7 L/min)

RP79315▲

1.8 GPM (6.8 L/min)

Aerator
Aireador
Aérateur

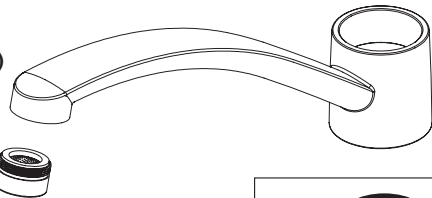

RP79316

Diverter Assembly, O-Rings & Slip Ring
Ensamble del Desviador, Anillos "O" y Anillo de Frotamiento
Dérivation, Joints Toriques et Anneau de Friction

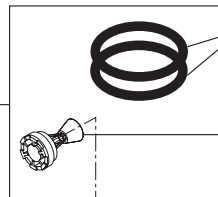

4 RP79317

O-Ring
Anillo O
Joint Torique

5 Diverter Assembly

Ensamble del Desviador
Dérivation

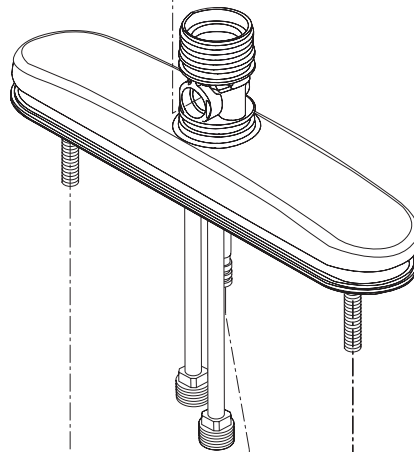

RP60121

Blocks & O-Rings
Bloques y Aros-O
Blocs de fixation et joints toriques

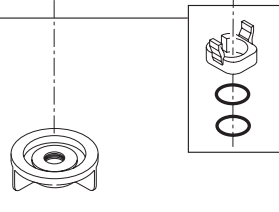

RP41667

Locknuts
Contratuercas
Écrous de Blocage

**For deck mount models
Para modelos con montura**

Pour modèles se montant sur la surface adjacente

RP47423

Washer, Nut & Screws
Arandelas, Tuerca y Tornillos
Rondelle, Écrou et Vis

For single hole mount models

**Para modelos con instalación de un hoyo
Pour modèles se montant dans un seul trou**

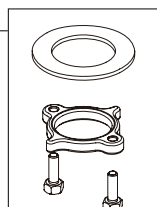

RP5861

Coupling Nuts (Optional, not included)
Tuercas de Acoplamiento (Opcional, no incluido)
Écrous de Raccordement (Option, non inclus)

RP70234▲

Spray, Hose Assembly & Spray Support
Ensamble de la Rociador, Manguera y Soporte
Douchette, Tuyau Souple et Support

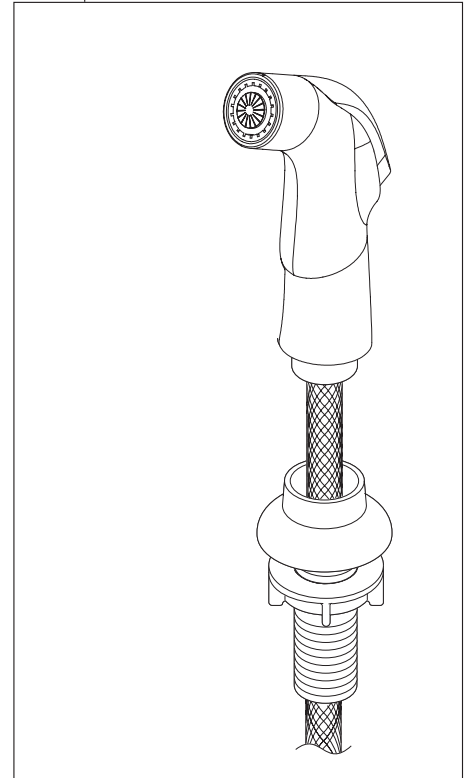

▲ Specify Finish
Especifique el acabado
Précisez la Finition