



USE AND INSTALLATION INSTRUCTIONS

Thank you very much for purchasing this Air Conditioner. Please read these Use And Installation Instructions carefully before installing and using this appliance and keep this manual for future reference.

Contents

Safety Instructions	1
Preparation before Use	2
Preset	2
Safeguarding the Environment	2
Safety Precautions	3
Identification of Parts	4
Indoor Unit	4
Outdoor Unit	4
Display Introduction	5
Care and Maintenance	6
Protection	7
Energy Saving Tips	8
Troubleshooting	9
Installation Instructions	10
Installation Diagram	10
Suggested Tools	11
Site Instructions	12
Indoor Unit Installation	13
Outdoor Unit Installation	17
Power and Wiring	19
Vacuum Testing and Charging	21
Start-up	22

For remote controller operating instructions. See "remote controller instructions".

For the most up-to-date version of the instructions, please visit www.dialmfg.com/hvac/technical.

Safety Instructions

- Warning: Risk of electric shock can cause injury or death. Disconnect all remote electric power supplies before servicing.
- The air conditioner must be installed by professional or qualified persons.
- To ensure the unit work will function properly, please read this manual carefully before installation, and install strictly according to this manual.
- Do not let air enter the refrigeration system or discharge refrigerant when moving the air conditioner.
- Properly ground all electrical connections.
- Check the connecting cables and pipes carefully, make sure they are correct and firm before connecting the power supply of the air conditioner.
- There must be an air-break switch.
- After installing, the consumer must operate the air conditioner correctly according to this manual, keep a suitable storage for maintenance and moving of the air conditioner in the future.
- Fuse of Indoor and Outdoor Units:

Model	Fuse of Indoor unit	Fuse of outdoor unit
9K-12K	T 3.15A 250V	T 15A 250V
18K	T 3.15A 250V	T 20A 250V
24K-36K	T 3.15A 250V	T 30A 250V

- A residual current device (RCD) with the rating of above 10mA shall be incorporated in the fixed wiring according to the national rule.
- The best length of the connecting pipe between the indoor unit and outdoor unit is less than 7.5 meters (24.6ft). If the distance is longer than that length, it will affect the efficiency of the air conditioner.
- This appliance can be used by children aged from 8 years and above and persons with reduced physical, sensory or mental capabilities or lack of experience and knowledge if they have been given supervision or instruction concerning use of the appliance in a safe way and understand the hazards involved. Children shall not play with the appliance. Cleaning and user maintenance shall not be made by children without supervision.
- The batteries in the remote controller must be recycled or disposed of properly. Disposal of Scrap Batteries --- Please discard the batteries as sorted municipal waste at the accessible collection point.
- If the appliance is fixed wiring, the appliance must be fitted with means for disconnection from the supply mains having a contact separation in all poles that provide full disconnection under overvoltage category III conditions, and these means must be incorporated in the fixed wiring in accordance with the wiring rules. If the supply cord is damaged, it must be replaced by the manufacturer, its service agent or similarly qualified persons in order to avoid a hazard.
- The appliance shall be installed in accordance with local electrical safety regulations and National Electrical Codes(NEC).
- The appliance shall not be installed in the laundry.

Preparation before Use

Note

- When charging refrigerant into the system, make sure to charge in liquid state, if the refrigerant of the appliance is R-410A. Otherwise, the chemical composition of refrigerant (R-410A) inside the system may change and thus affect performance of the air conditioner.
- Due to the characteristics of refrigerant (R-410A, the value of GWP is 2088), the pressure within the tube may be very high, use extreme care when installing and repairing the appliance.
- If the power supply cord is damaged, it must be replaced by the manufacturer, its service agent or similarly qualified persons in order to avoid a hazard.
- The air conditioner must be installed by trained, qualified installers and service mechanics.
- The temperature of refrigerant circuit will be high, please keep the interconnection cable away from the copper tube.

Safeguarding the environment

This appliance is made of recyclable or re-usable material. Scrapping must be carried out in compliance with local waste disposal regulations. Before scrapping it, make sure to cut off the power cord so that the appliance cannot be re-used.

For more detailed information on handling and recycling this product, contact your local authorities who deal with the separate collection of rubbish or the shop where you bought the appliance.

SCRAPPING OF APPLIANCE

This marking indicates that this product should not be disposed with other household wastes throughout the North America. To prevent possible harm to the environment or human health from uncontrolled waste disposal, recycle it responsibly to promote the sustainable reuse of material resources. To return your used device, please use the return and collection systems or contact the retailer where the product was purchased. They can take this product for environmental safe recycling.



Safety Precautions

Symbols in this Use and Care Manual are interpreted as shown below.



Be sure not to do.





















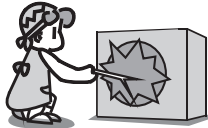

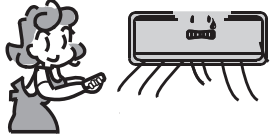

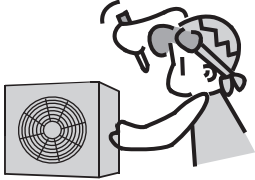

Grounding is essential.

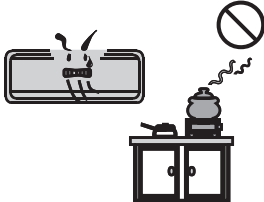

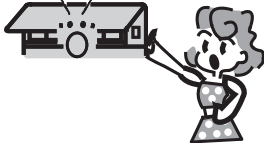
Pay attention to such a situation.



Warning: Incorrect handling could cause a serious hazard, such as death, serious injury, etc.

 <p>Use correct power supply in accordance with the rating plate requirement. Otherwise, serious faults or hazard may occur or a fire maybe break out.</p>	  <p>Keep the power supply circuit breaker or plug from dirt. Connect the power supply cord to it firmly and correctly, lest an electric shock or a fire break out due to insufficient contact.</p>	   <p>Do not use the power supply circuit breaker or pull off the plug to turn it off during operation. This may cause a fire due to spark, etc.</p>
  <p>Do not tie, pull or press the power supply cord, lest the power supply cord be broken. An electric shock or fire is probably caused by a broken power supply cord.</p>	  <p>Never insert a stick or similar obstacle to the unit. Since the fan rotates at high speed, this may cause an injury.</p>	  <p>Exposure to cool air for a prolonged period of time is harmful to your health.</p>
  <p>Turn off the appliance by remote control before cutting off power supply if malfunction occurs.</p>	  <p>Do not repair the appliance by yourself. If this is done incorrectly, it may cause an electric shock, etc.</p>	  <p>Prevent the air flow from reaching gas burners and stove.</p>
  <p>Do not touch the operation buttons when your hands are wet.</p>	  <p>Do not put any objects on the outdoor unit.</p>	  <p>It is the user's responsibility to make the appliance be grounded according to local codes or ordinances by a licenced technician.</p>

Identification of Parts

Indoor unit

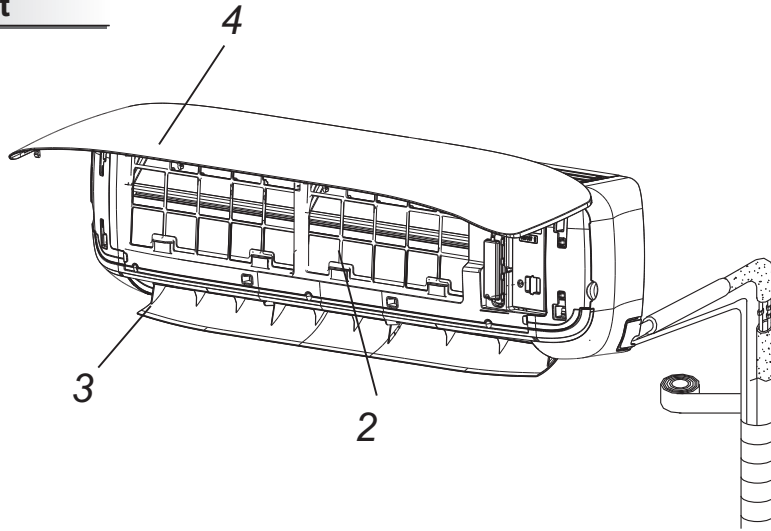

Part Name



1. Remote Controller

2. Air Filter

3. Horizontal Louvers

4. Front Panel

5. Pipes and Power Connection Cord

6. Drain Hose

Outdoor unit

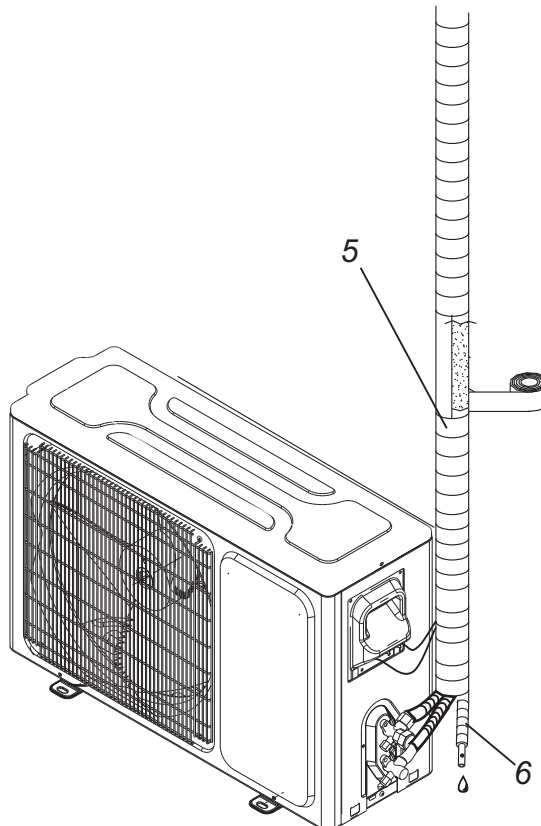

☑ The figures in this manual are based on the external view of a standard model. Consequently, the shape may differ from that of the air conditioner you have selected.

Display Introduction

88

Temperature indicator 1

Display set temperature.
It shows FC after 200 hours of usage as reminder to clean the filter.
After filter cleaning press the filter reset button located on the indoor unit behind the front panel in order to reset the display (optional).



Running indicator 2

It lights up when the AC is running.
It flashes during defrosting.



Timer indicator 3

It lights up during set time.



Sleep indicator 4

It lights up in sleep mode.

Signal Receptor 5

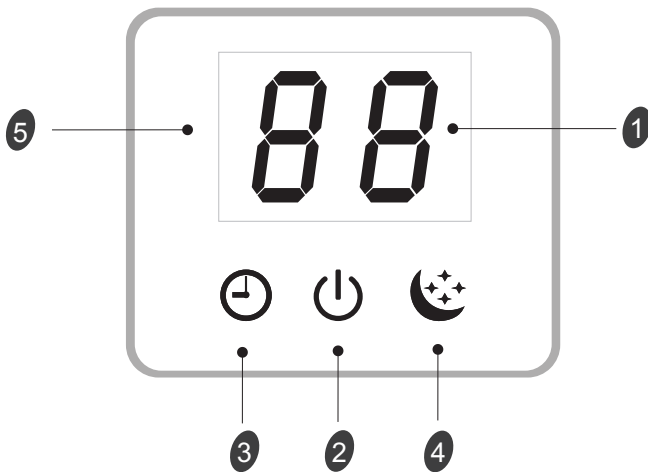

Emergency button 6

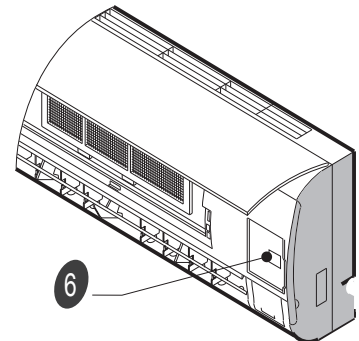

ON/OFF To let the AC run or stop by pressing the button.

Care and Maintenance

Front panel maintenance

- 1 Cut off the power supply**

Turn off the appliance first before disconnecting from power supply.

- 2**

Grasp position "a" and pull outward to remove the front panel.

- 3 Wipe with a soft and dry cloth.**

Use soft moisture cloth to clean if the front panel is very dirty.



Use a dry and soft cloth to clean it.
- 4 Never use volatile substance such as gasoline or detergent to clean the appliance.**



- 5 Never sprinkle water onto the indoor unit**



Dangerous!
Electric shock!
- 6 Reinstall and shut the front panel.**

Reinstall and shut the front panel by pressing position "b" downward.



Air filter maintenance

It is necessary to clean the air filter after using it for about 200 hours.

Clean it as follows:

- 1 Stop the appliance and remove the air filter.**

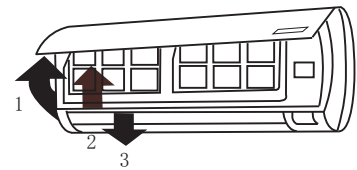
 - Open the front panel.
 - Press the handle of the filter gently from the front.
 - Grasp the handle and slide out the filter.
- 2 Clean and reinstall the air filter.**

If the dirt is conspicuous, wash it with a solution of detergent in lukewarm water. After cleaning, dry thoroughly in shade.

- 3 Close the front panel again.**

Clean the air filter every two weeks if the air conditioner operates in an extremely dusty environment.

Protection

Operating condition

The appliance is equipped with a protective device operating in the following circumstances.

HEATING	Outdoor air temperature is over 75°F(24°C)
	Outdoor air temperature is below 5°F(-15°C)
	Room temperature is over 80.6°F(27°C)
COOLING	Outdoor air temperature is over *115°F(46°C)
	Room temperature is below 70°F(21°C)
DRY	Room temperature is below 64.5°F(18°C)

**For Tropical (T3) Climate conditions, the temperature point is 131°F(55°C) instead of 115°F(45°C). The temperature of some products is allowed beyond the range. In specific situations, please consult the merchant.
If the air conditioner runs in COOLING or DRY mode with door or window opened for a long time when relative humidity is above 80%, dew may drip down from the outlet.*

Noise pollution

- Install the air conditioner at a place that can support its weight in order to operate more quietly.
- Install the outdoor unit at a place where the air discharged and the operation noise will not annoy your neighbors.
- Do not place any obstacles in front of the air outlet of the outdoor unit lest it increases the noise level.

Features of protective device

The protective device will work in the following instances.

- 1 Restarting the unit at once after operation stops or changing modes during operation, will result delay of 3 minutes.
- 2 If all operation has stopped, press **ON/OFF** button to restart, the Timer will need to be set again if it has been canceled.

Features of HEATING mode

Preheat

Within 2-5 minutes of the beginning of the HEATING operation, the airflow from the indoor unit will begin to discharge.

Defrost

In **HEATING** operation the appliance will defrost (de-ice) automatically to raise efficiency. This procedure usually lasts 2-10 minutes. During defrosting, the fan will stop operating. After defrosting completes, it returns to **HEATING** mode automatically.

Note: Heating is NOT available for cooling only air conditioner models.

Energy Saving Tips

- 1. Relaxing room temperature at night is OK:** During the nighttime hours you may not require the same level of cooling or heating. Try using Sleep mode to gradually relax room temperature and allow the unit to run less and save energy.
- 2. Curtains and shades:** In the summer, close window curtains and shades on the south and west side of your home to help block solar heat. In winter, open curtains and shades to allow solar heat into your room.
- 3. Close doors:** If you don't need to heat and cool your whole home, confine the heating and cooling to one room by closing doors. Limit the space you're heating and cooling to specified capability of the unit.
- 4. Service the unit:** Some basic maintenance is recommended. The outdoor unit will greatly benefit from a good hosing out, especially in treed areas where seeds and other debris can stick to coil fins and make the unit work harder!
- 5. Rearrange the room:** Furniture that obstructs airflow means you could be heating and cooling the back of a chair or the front of a sofa instead of the actual living space. Use the swing louvers to help direct the air in the right direction for the room; remove or rearrange obstacles blocking airflow.
- 6. Try 75 degrees:** 75°F (24°C) is a good point for an air conditioner to run at its optimal performance level. Even a 1-degree change in temperature can make your unit use more energy!
- 7. Lighting:** Turning lights off can help reduce your heat. Each light bulb is a tiny heater. Your air conditioner must waste energy overcoming the heat from your lights to reach and hold your desired room temperature.
- 8. Is anyone home?** If possible, while you're away turn your unit to Auto mode and make sure windows and drapes are closed. Although the room temperature will be uncomfortable for a few minutes when you come home, the unit will have the room back to your desired temperature in no time.
- 9. Don't forget the fan:** Try saving money by using the comfortable quiet low fan speed as much as possible.

Troubleshooting

The following cases may not always be a malfunction, please check it before asking for service.

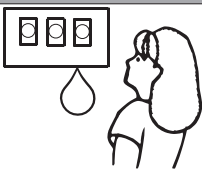
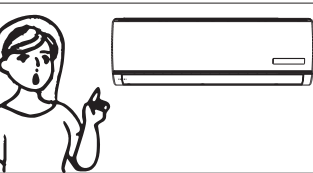
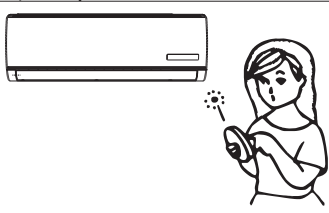
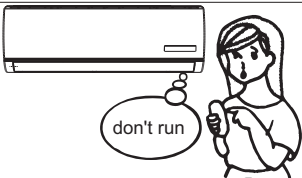
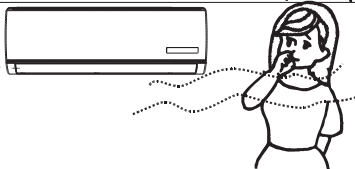
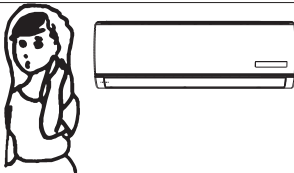
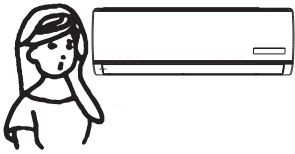
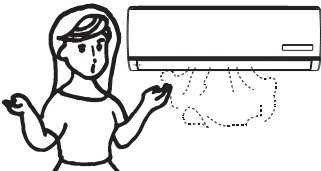
Trouble	Analysis
<p>Does not run</p> 	<ul style="list-style-type: none"> • If the protector trips a fuse is blown, please wait 3 minutes and start again. The protector device may be preventing unit from working. • The batteries in the remote control may be dead • Check to see if the appliance is properly plugged in.
<p>No cooling or heating air</p> 	<ul style="list-style-type: none"> • Is the air filter dirty? • Are the intakes and outlets of the air conditioner blocked? • Is the temperature set properly? • Are doors or windows open?
<p>Ineffective control</p> 	<ul style="list-style-type: none"> • If there is strong interference (from excessive static electricity discharge or power supply voltage abnormality), the appliance may operate abnormally. Disconnect the power supply and connect back 2-3 seconds later.
<p>Does not operate immediately</p> 	<ul style="list-style-type: none"> • Changing mode during operation, there will be a 3 minute delay.
<p>Peculiar odor</p> 	<ul style="list-style-type: none"> • This odor may come from another source such as furniture, cigarette etc, which is sucked in the unit and blows out with the air.
<p>A sound of flowing water</p> 	<ul style="list-style-type: none"> • Caused by the flow of refrigerant in the air conditioner. Not a cause for concern. • Sound of defrosting during heating mode.
<p>Cracking sound is heard</p> 	<ul style="list-style-type: none"> • The sound may be generated by the expansion or contraction of the front panel due to change of temperature.
<p>Spraying mist from the outlet</p> 	<ul style="list-style-type: none"> • Mist appears when the air in the room becomes very cold. This is because of the cool air discharged from the indoor unit during COOLING or DRY modes.
<p>The compressor indicator lights on constantly, running indicator flashes and indoor fan stops.</p>	<ul style="list-style-type: none"> • The unit is shifting from heating mode to defrost. The indicator will light off and return to heating mode.

Installation Instructions

Installation diagram

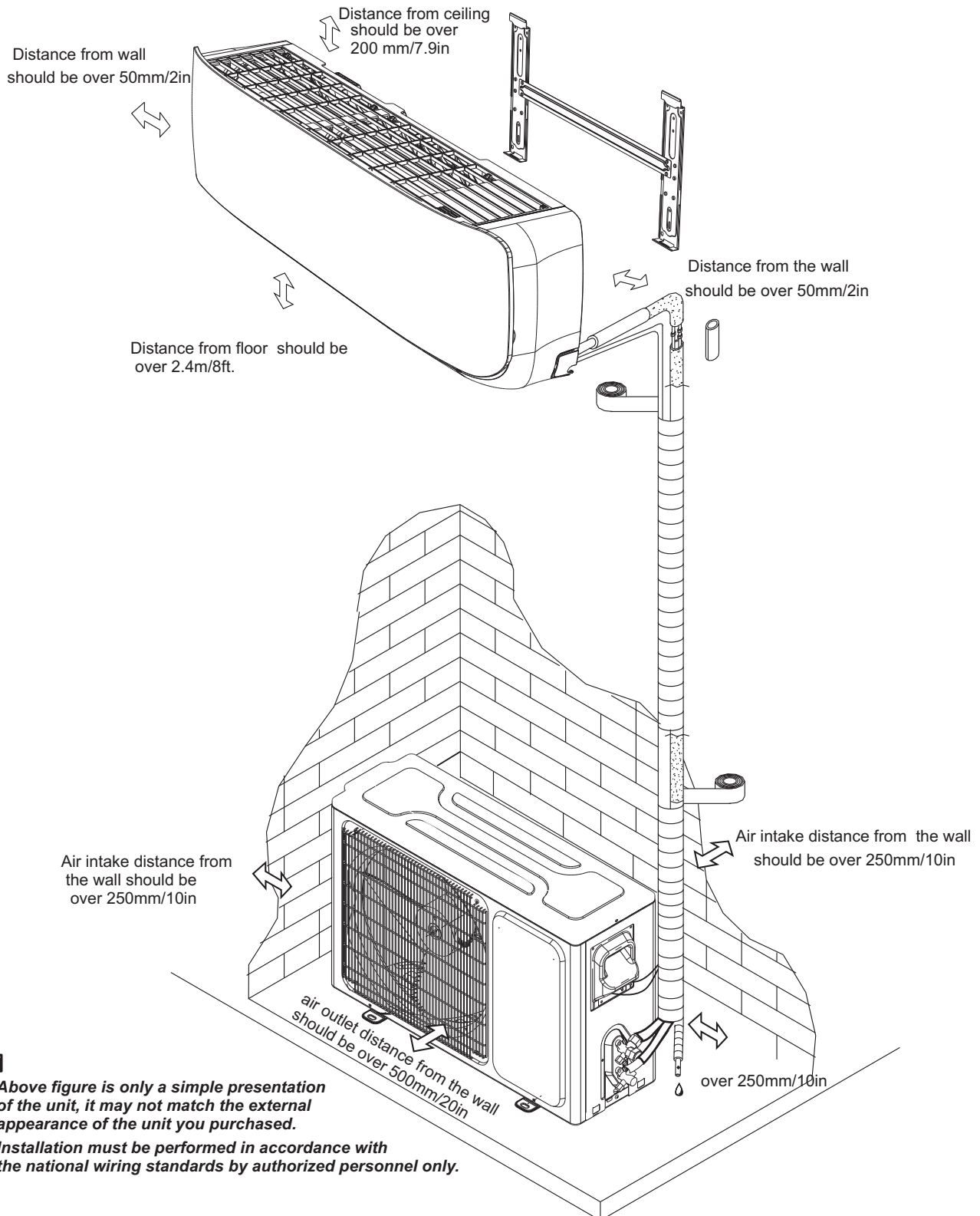

Installation Instructions

Suggested Tools

In order to install your air-conditioner more conveniently and safely, the tools listed below are recommended.



Standard Wrench



Screw Driver



Hex Keys or Allen Wrenches



Adjustable/Crescent Wrench



Torque wrench



Drill & Drill Bits



Manifold and Gauges



Vacuum Pump

Clamp on Amp Meter Level

Work Gloves

Safety Glasses

Pipe Cutter

Refrigerant Scale

R410A Flaring Tool

Micron Gauge

Hole Saw



Installation Instructions

Site Instructions

Site for Installing Indoor Unit

- Where there is no obstacle near the air outlet and air can be easily blown to every corner.
 - Where piping and wall-hole can be easily arranged.
 - Keep the required space from the unit to the ceiling and wall according to the installation diagram on page 10.
 - Where the air filter can be easily removed.
 - Keep the unit and remote controller 1m(3.28ft) or more apart from television, radio etc.
 - keep as far as possible from fluorescent lamps.
 - Do not obstruct the air inlet.
- Install on a wall that is strong enough to bear the weight of the unit.
- Install in a place that will not increase operation noise and vibration.
 - Keep away from direct sunlight and heating sources. Do not place flammable materials or combustion apparatuses on top of the unit.

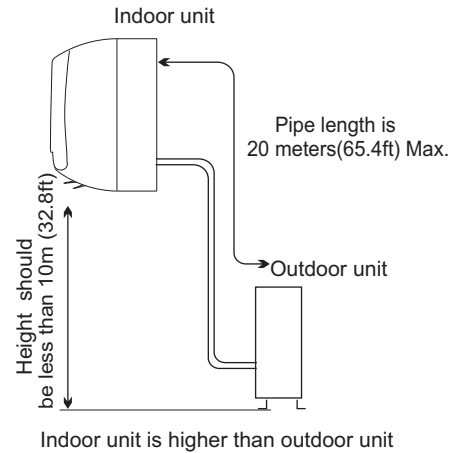

Site for Installing Outdoor Unit

- Where it is convenient to install and well ventilated.
- Avoid installing it where flammable gas could leak.
- Keep the required distance apart from the wall.
- Keep the outdoor unit away from dirt.
- Avoid installing the outdoor unit by the roadside or anywhere there is a risk of muddy water.
- Install on a fixed base where it is not subject to increased operation noise.
- Install where there is no blockage of the air outlet.
- Avoid installing under direct sunlight, in an aisle or sidewalk, or near heat sources and ventilation fans. Keep away from flammable materials, thick oil, and wet or uneven places.
- In case the pipe length is more than 7.5m(24.6ft), the refrigerant should be charged additionally, according to below table.

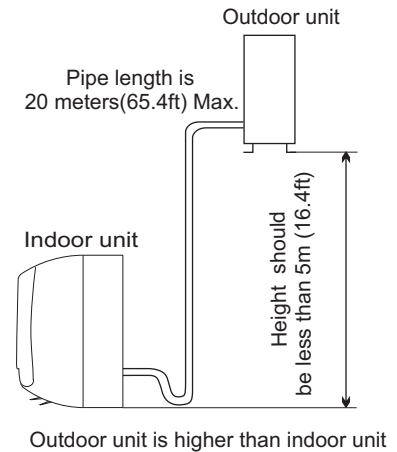

Model	Required amount of additional refrigerant (g/m)
9K-18K	20
24K	30
30K-36K	40

If the height or pipe length is out of the scope of the table, please consult the merchant.

Installation Instructions

Indoor unit installation

1. Installing the Mounting Plate

- Decide on a installation location for the mounting plate according to the indoor unit location and piping direction.

Note: it is recommended to install screw anchors for sheet rock, concrete block, brick and such type of wall.

- Keep the mounting plate horizontal with a horizontal level or dropping line.
- Mark the center of the indoor unit on mounting plate for future reference.

Note: the center of the mounting bracket may be not the center of the indoor unit.

- Secure mounting plate to the wall with a minimum of five screws, evenly spaced to properly support indoor unit weight.

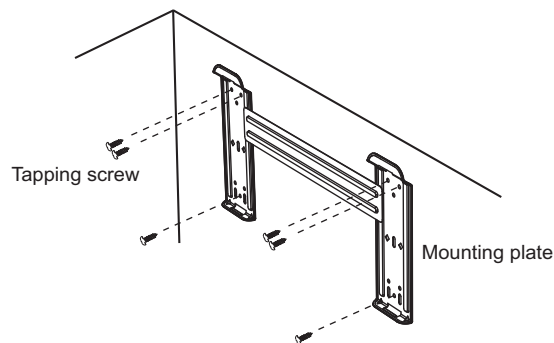

Note: The shape of your mounting plate may be different from the one above, but the installation method is similar.

Note: As shown in the the above figure, the six holes matched with tapping screw on the mounting plate must be used to fix the mounting plate.

MOUNTING BRACKET DIAGRAMS AND DIMENSIONS (Recommended)

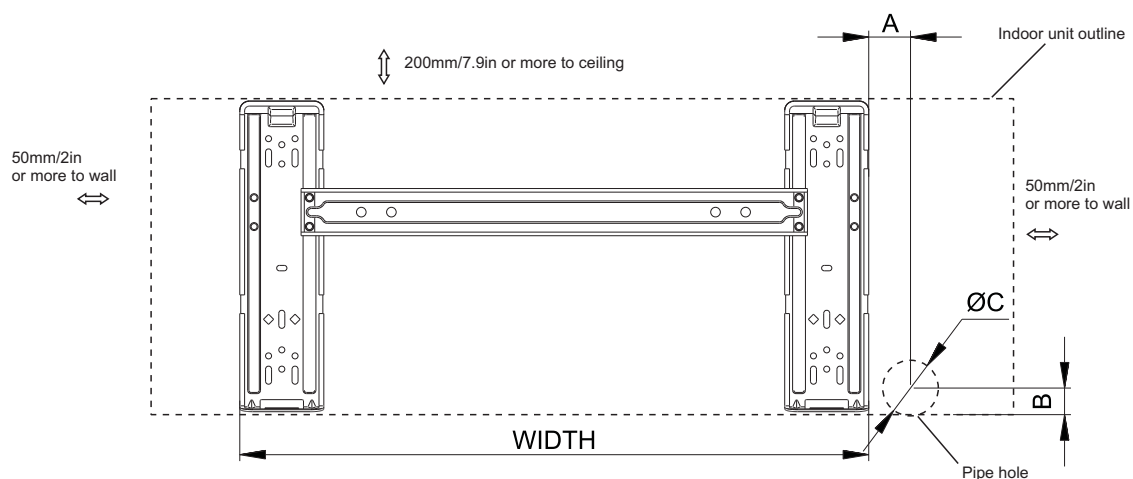

For Models 9000-16S-230 and 9000-19S-115, WIDTH: 522mm/20.6in
For Models 12000-17S-115 and 12000-20S-230, WIDTH: 592mm/23.3in

Installation Instructions

Indoor unit installation

MOUNTING BRACKET DIAGRAMS AND DIMENSIONS (Recommended)

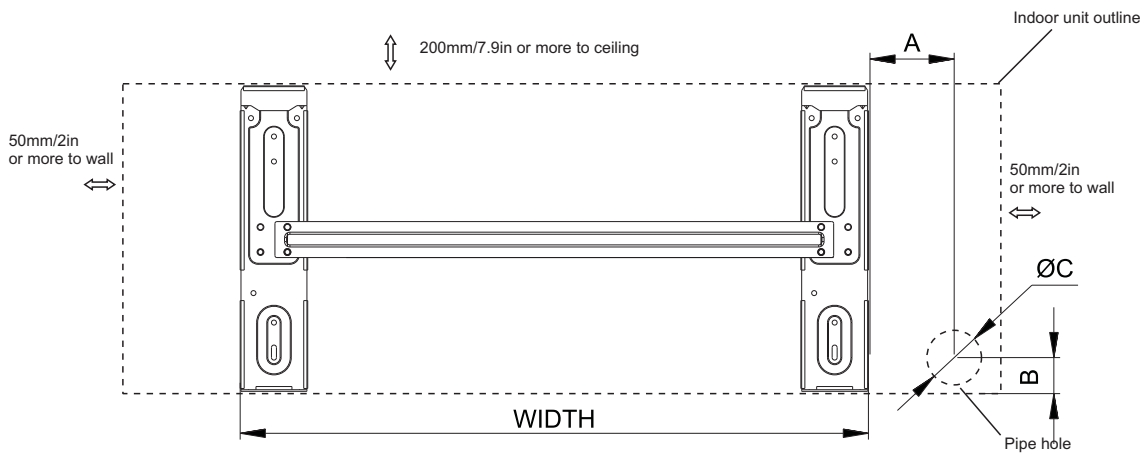

For Models 18000-17S-230, 24000-20S-230 and 18000-23S-230, WIDTH: 629mm/24.8in

Installation Instructions

Indoor unit installation

2. Drill a Hole in wall Piping, Drain & Wiring Connection

- Decide the position of the hole for piping according to the location of mounting plate.
- Drill a hole in the wall. The hole should tilt a little downward toward outside.
- Install a sleeve through the hole to keep the wall clean.

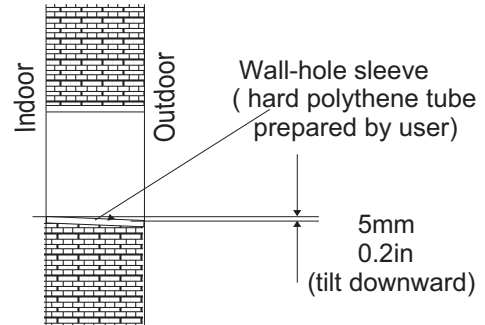
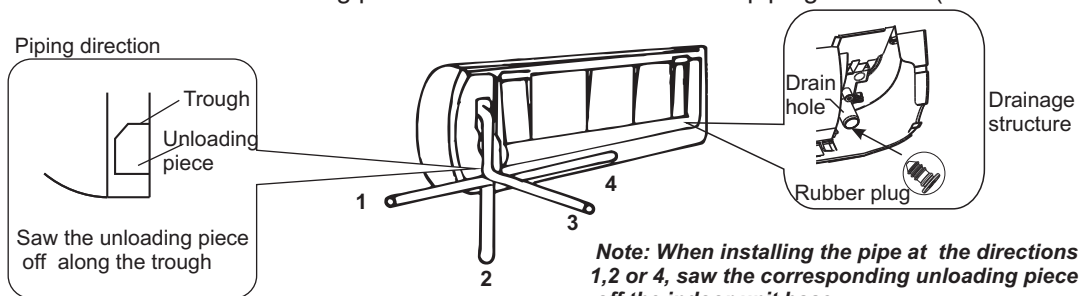

Table of Wall Hole Mounting size per Unit Size

Unit Model	Size A	Size B	Size C
	mm/in	mm/in	mm/in
9000-16S-230 9000-19S-115	68/2.68	33/1.3	70/2.7
12000-17S-115 12000-20S-230	70/2.75	35/1.38	70/2.7
18000-17S-230	137/5.4	40/1.57	70/2.7
24000-20S-230 18000-23S-230	170/6.7	40/1.57	70/2.7

3. Piping and Drain Hose Connections to Indoor Unit

- Put the piping (liquid and gas pipe) and cables through the wall-hole from outside or put them through from inside after indoor piping and cables connection is complete to connect to the outdoor unit.
- Decide whether to saw the unloading piece off in accordance with the piping direction (as shown below).



- After connecting the piping, install the drain hose. Then connect the power cords. After connecting, wrap the piping, cords and drain hose together with thermal insulation materials.

Note: Both sides drainage structure is standard. For both sides drainage structure, it can be chosen for right, left or both sides drainage connection. If choosing both sides drainage connection, another proper drain hose is needed as there is only one drain hose offered by factory. If choosing one side drainage connection, make sure the drain hole on the other side is well plugged.

Installation Instructions

Indoor unit installation

- **Piping Joints Thermal Insulation:** Wrap the piping joints with thermal insulation materials and then wrap with a vinyl tape.

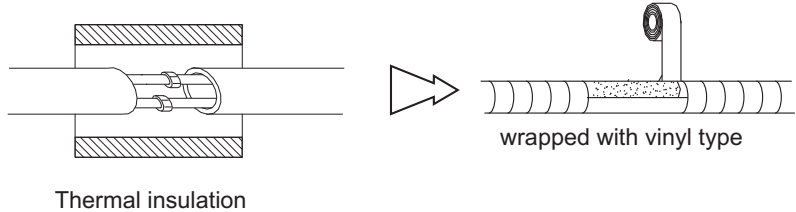

- **Piping Thermal Insulation:**

- Place the drain hose under the piping.
 - Insulation material uses polythene foam over 6mm in thickness.
- Note: Drain hose is prepared by user.**

- Do not arrange the drain pipe in a way that leaves it twisted, sticking out or waving around. Do not immerse the end of it in water.
- If an extension drain hose is connected to the drain pipe, make sure to insulated when passing along the indoor unit.
- When the piping is directed to the right, piping, power cord and drain pipe should be thermal insulated and fixed onto the back of the unit with a piping fixer.

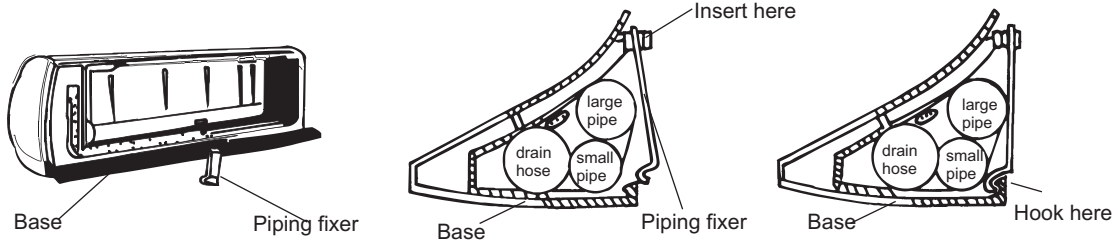
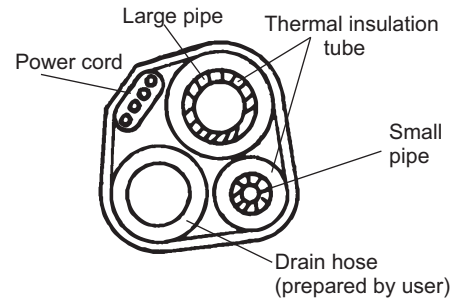

A. Insert the pipe fixer to the slot.

B. Press to hook the pipe fixer onto the base.

Piping Connection:

- Connect indoor unit pipes with two wrenches. Pay special attention to the allowed torque as shown below to prevent the pipes, connectors and flare nuts from being deformed and damaged.
- Pre-tighten them with fingers at first, then use the wrenches.

Model	Pipe size	Torque	Nut width	Min.thickness
9K-18K	Liquid Side (ϕ 6 or 1/4)	15~20N·m or 11~15ft-lbs	17 or 5/8	0.5 or 0.02
24K-36K	Liquid Side (ϕ 9.53 or 3/8)	30~35N·m or 22~26ft-lbs	22 or 7/8	0.6 or 0.024
9K-12K	Gas Side (ϕ 9.53 or 3/8)	30~35N·m or 22~26ft-lbs	22 or 7/8	0.6 or 0.024
18K	Gas Side (ϕ 12 or 1/2)	50~55N·m or 37~41ft-lbs	24 or 0.94	0.6 or 0.024
24K-36K	Gas Side (ϕ 16 or 5/8)	60~65N·m or 44~48ft-lbs	27 or 1.1	0.6 or 0.024

NOTE:

Dimensions are in "mm or inch" unless otherwise stated in the table.

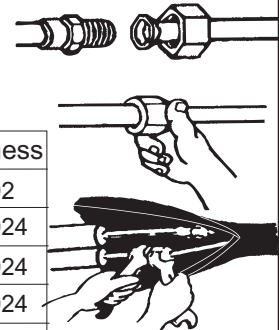

Installation Instructions

Outdoor Unit Installation

1. Install Condensate Drain for Outdoor Unit

Condensate drains from the outdoor unit when the unit operates in heating mode. In order not to disturb your neighbor and protect the environment, install a drain port and a drain hose to direct the condensate water. Install the drain port and rubber washer to the chassis of the outdoor unit, then connect a drain hose to the port as the right figure demonstrates.

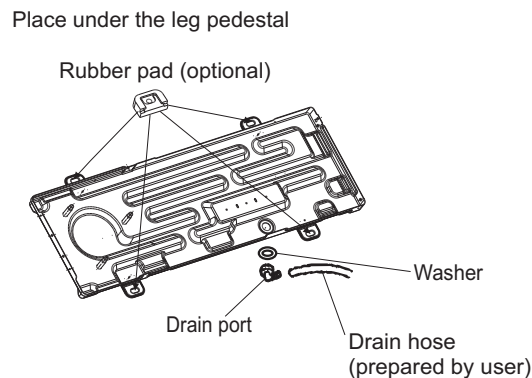

2. Install Ground Pad or Wall Hangers

1. Determine proper location for outdoor unit.
 2. Follow all instructions provided by hanger or pad manufacturer for installing wall hangers rubber pad.
 3. Verify the wall hangers or rubber pad can safely support the weight of the outdoor unit.
 4. Verify the wall hangers or rubber pad is level and meets all outdoor dimensional clearance.
 5. Fix with bolts and nuts tightly on a flat and strong floor.
- If installed on the wall or roof, make sure to fix the supporter well to prevent it from shaking due to serious vibration or strong wind.

WARNING

Florida wind load requirements state that outdoor unit must be anchored to concrete pad using four 3/8-in diameter power wedge bolt plus(or equivalent) with 1-in diameter fender washers. Anchor bolts must be embedded into 3000 PSI minimum concrete at a distance of 4 1/2- in from any concrete edge. The concrete thickness must exceed 1.5 times the anchor depth.

Installation Instructions

3. Piping Connections to Outdoor Unit

- Remove service valve cover(if provided) to access the service valves and refrigerant ports.
- Carefully bend and adjust length of refrigerant pipes to meet outdoor unit service valve connections with proper tools to avoid kinks.
- Apply a small amount of refrigerant oil to the flare connection on the refrigerant pipe.
- Properly align piping and tighten flare nut using a standard wrench and a torque wrench as shown in the indoor piping section.
- Carefully tighten flare nuts to correct torque level referring to the following Torque Table:

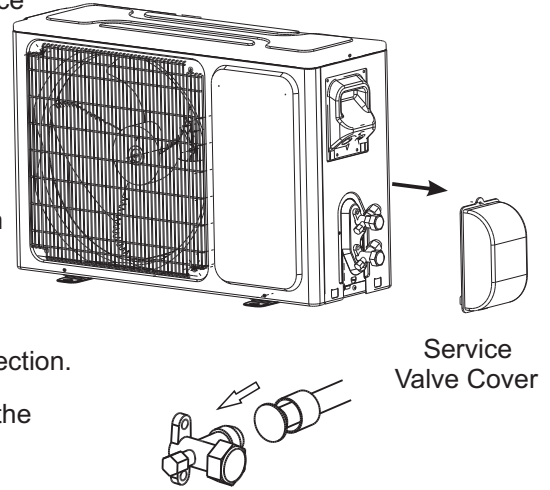

Service Valve Cover

Torque Table

Pipe diameter /inch(mm)	Nut Size /inch(mm)	Tightening Torque	
		ft-lbs	N-m
1/4(6.35)	1/4(17)	11 to 15	15 to 20
3/8(9.5)	3/8(22)	22 to 26	30 to 35
1/2(12.7)	1/2(25)	37 to 41	50 to 55
5/8(15.9)	5/8(29)	44 to 48	60 to 65

Note: Over tightening may damage flare connections and cause leaks.

Installation Instructions

Power and Wiring

Connecting the Power Cord

Indoor Unit

Connect the power cord to the indoor unit by connecting the wires to the terminals on the control board individually in accordance with the Wiring diagram on page 20.

Note: For some models, it is necessary to remove the cabinet to connect to the indoor unit terminal.

Outdoor Unit

1) Remove the cable cross board from the unit by loosening the screw. Connect the wires to the terminals on the control board individually as follows.

2) Secure the power cord onto the control board with cable clamp.

3) Reinstall the cable cross board to the original position with the screw.

4) Use a recognized circuit breaker for 24K model between the power source and the unit. A disconnecting device must be fitted to adequately disconnect all supply lines.

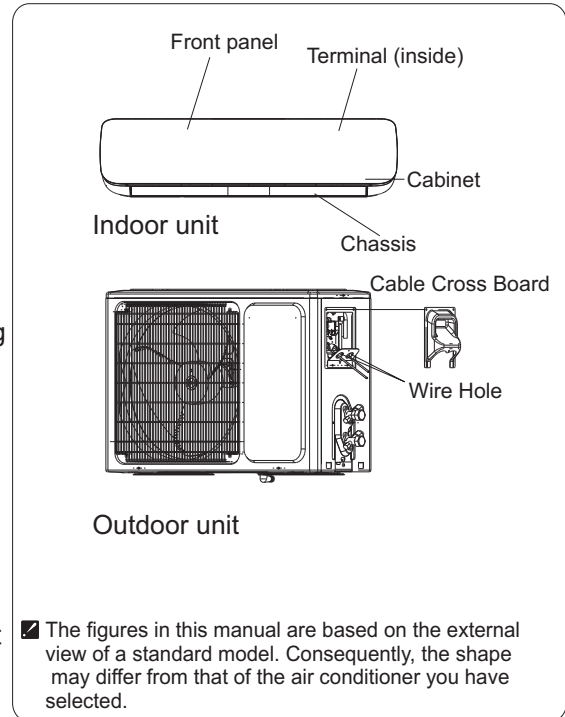

Caution:

1. Never fail to have an individual power circuit specifically for the air conditioner. As for the method of wiring, refer to the circuit diagram posted on the inside of the access door .
2. Confirm that the cable thickness is as specified in the power source specification.
3. Check the wires and make sure that they are all tightly fastened after cable connection.
4. Be sure to install an earth leakage circuit breaker in wet or moist areas.

Cable Specifications

capacity(Btuh)	Power cord		Power connecting cord	
	Type	Normal cross-sectional areas	Type	Normal cross-sectional areas
9K-12K	SJ TW	3X16 AWG	SJ TW	4X18 AWG
18K-24K	SJ TW	3X14 AWG	SJ TW	4X18 AWG
30K-36K	SJ TW	3X12 AWG	SJ TW	4X18 AWG

Attention:

The plug must be accessible even after the installation of the appliance in case there is a need to disconnect it. If not possible, connect appliance to a double-pole switching device with contact separation of at least 3mm² placed in an accessible position even after installation.

Installation Instructions

Wiring diagram

Make sure that the color of the wires in the outdoor unit and terminal No. are the same as those of the indoor unit.

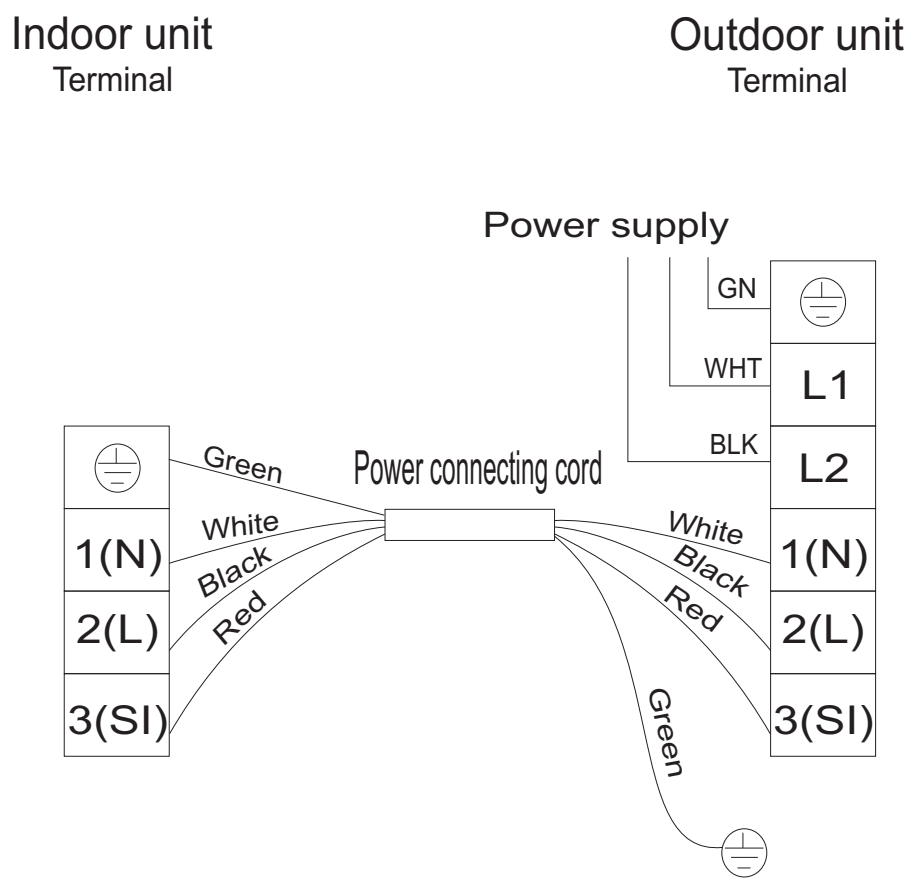

☑ The diagram is reference only, and the actual terminal shall prevail.

Installation Instructions

Vacuum Testing and Charging

Air containing moisture which remains in the refrigeration cycle may cause a malfunction on the compressor. After connecting the indoor and outdoor units, release air and moisture from the refrigerant cycle using a vacuum pump, as shown below.

Note: To protect the environment, be sure not to discharge the refrigerant to the air directly.
See next page for air purging steps.

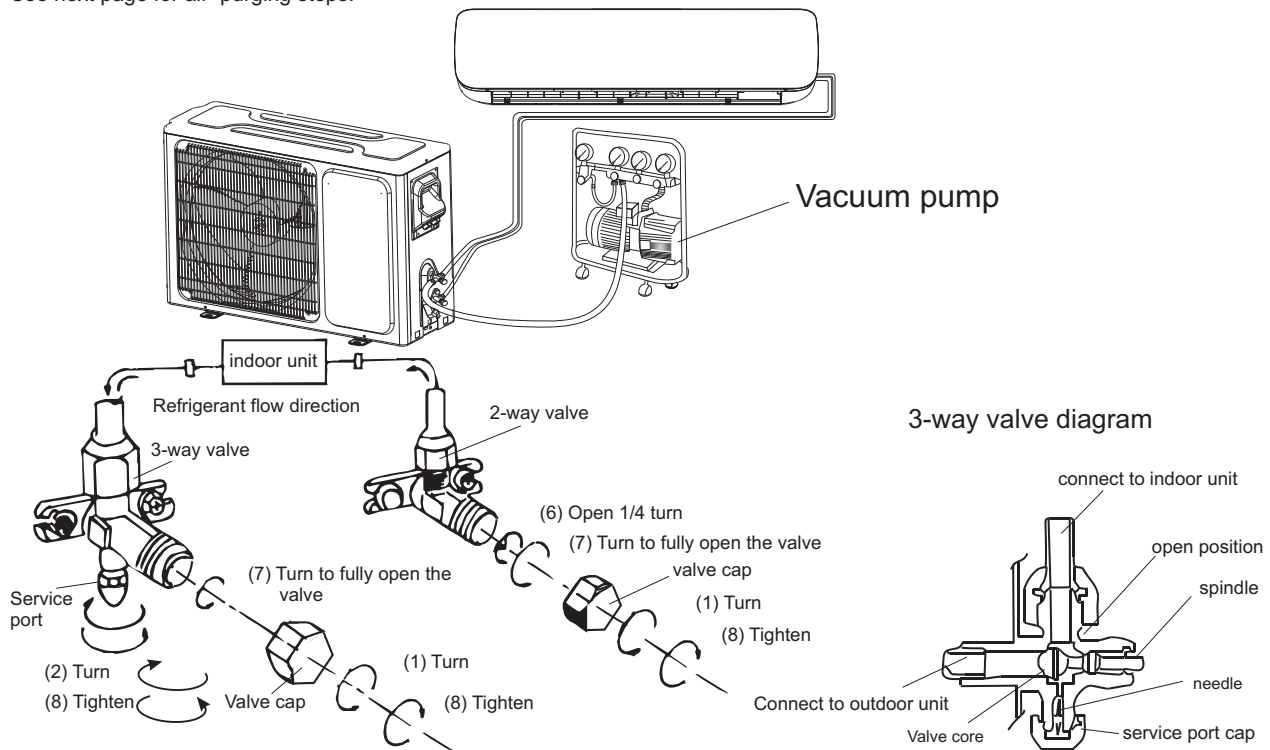

How to Vacuum Air Tubes:

- (1) Unscrew and remove caps from 2 and 3-way valves.
- (2) Unscrew and remove cap from service valve.
- (3) Connect vacuum pump flexible hose to the service valve.
- (4) Start vacuum pump for 10-15 minutes until reaching a vacuum of 10 mm Hg absolute.
- (5) With vacuum pump still running close the low pressure knob on vacuum pump manifold. Then stop the vacuum pump.
- (6) Open 2-way valve, 1/4 turn, then close it after 10 seconds. Check tightness of all joints using liquid soap or an electronic leak detector.
- (7) Turn 2 and 3-way valves stem to fully close the valves. Disconnect the flexible vacuum pump hose.
- (8) Replace and tighten all valve caps.

Installation Instructions

Start-up

Test Operation

Perform test operation after completing gas leak and electrical safety check.

1. Turn on electrical power to outdoor unit.
2. Push the "ON/OFF" button on Remote Controller to begin testing.
3. Push MODE button, select COOLING, HEATING, FAN mode to confirm all functions.

System Checks

1. Conceal refrigerant pipes where possible.
2. Make sure drain hose slopes downward along entire length.
3. Ensure all refrigerant pipes and connections are properly insulated.
4. Fasten pipes to outside wall, when possible.
5. Seal and weatherproof wall-hole through which the interconnecting wires and refrigerant pipes pass.

Indoor Unit

1. Do all Remote controller's buttons function properly?
2. Do the display panel lights work properly?
3. Does the swing louver function properly?
4. Does the drain work?

Outdoor Unit

1. Push the mode button to COOL and adjust the room setting to 61 °F(16°C) deg. wait up to 3 minutes from compressor time guard. Does compressor and outdoor fan turn on in cooling mode?
2. Push the mode button to HEAT and adjust the room setting to 85 °F(30°C)deg. wait up to 3 minutes for compressor time guard. Does compressor and outdoor fan turn on in heat mode?