

Installation and Owner's Manual
Manual de instalación y del propietario
Manuel d'installation et d'utilisation
Manual de Instalação e do Proprietário

TOTO

Single Handle Lavatory Faucet
Grifo de Lavabo de Una Manija
Robinete de Lavabo à une Manette
Faucet de Alça Única com Balcão de Banheiro

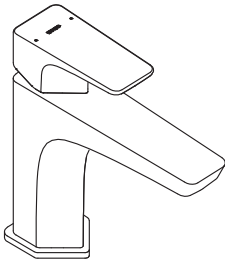

GE
TLG07301U
TLG07303U
TLG07305U

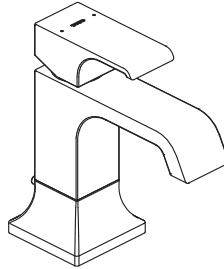

GC
TLG08301U
TLG08303U
TLG08305U

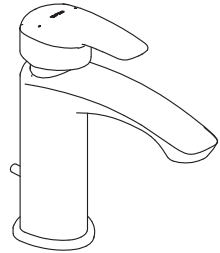

GM
TLG09301U
TLG09303U
TLG09305U

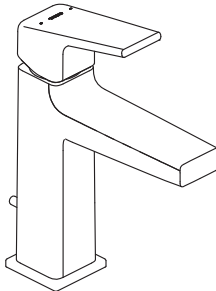

GB
TLG010301U
TLG010303U
TLG010305U

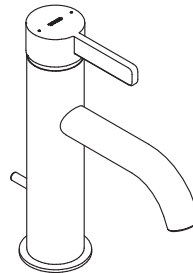

GF
TLG011301U
TLG011303U
TLG011305U

Warranty Registration and Inquiry

For product warranty registration, TOTO U.S.A. Inc. recommends online warranty registration. Please visit our web site <http://www.totousa.com>. If you have questions regarding warranty policy or coverage, please contact TOTO U.S.A. Inc., Customer Service Department, 1155 Southern Road, Morrow, GA 30260 (888) 295-8134 or (678) 466-1300 when calling from outside of U.S.A.

TABLE OF CONTENTS

Thanks for Choosing TOTO!.....	2	Tools You Will Need.....	3
Warnings.....	2	Specifications.....	3
Before Installation.....	2	Installation Procedure.....	4
Care and Cleaning.....	2	Warranty.....	8
Included Parts.....	3	Rough-In Dimensions.....	30

THANK YOU FOR CHOOSING TOTO!

The mission of TOTO is to provide the world with healthy, hygienic and more comfortable lifestyles. We design every product with the balance of form and function as a guiding principle. Congratulations on your choice.

WARNINGS

For safe operation of the faucet, please observe the following:

- Operating Pressure:
 - Minimum Pressure.....20 psi (138 kPa), dynamic
 - Maximum Pressure.....80 psi (551 kPa), static
- Do not use the product at an ambient temperature below 32° F (0° C)

BEFORE INSTALLATION

- Observe all local plumbing codes.
- Before installing the faucet, be sure to thoroughly flush the supply pipes of dirt and debris.
- Make sure the water supply is shut off at the stop valve.
- Read these instructions carefully to ensure proper installation.
- TOTO reserves the right to update product design without notice.

CARE AND CLEANING

Your new faucet is designed for years of trouble-free performance. Keep it looking new by cleaning it periodically with mild soap, rinsing thoroughly with warm water and drying with a clean, soft cloth. Do not use abrasive cleaners, steel wool or harsh chemicals, as these will dull the finish. Failure to follow these instructions may void your warranty

INCLUDED PARTS

Check to make sure you have the following parts indicated below:

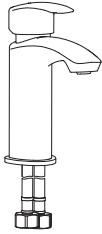

Spout Assembly*

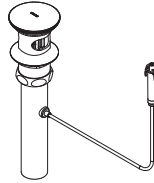

Drain Assembly



Aerator Key
GE GB GM GF



Aerator Key GC



Spout Mounting Hardware

TOOLS YOU WILL NEED



Adjustable
Wrench

SPECIFICATIONS

Water Supply Pressure	Minimum required: 20 psi (138 kPa) (Flowing)
	Maximum allowed: 80 psi (551 kPa)
Water Supply Connection	3/8 Comp
Ambient Temperature	32~104°F (0~40°C)
Humidity	Max. 90% RH
Flow Rate	Maximum 1.2 gallon/min (4.5 L/min)

INSTALLATION PROCEDURE

ENGLISH

Faucet

1. Place gaskets under spout.

Pass the supply hoses and mounting studs through the mounting holes until the spout comes to rest.

2. Orient the spout as needed. From below the mounting surface, place the crescent shaped washer over the mounting studs as shown.

Fasten the mounting nuts to the studs to secure the spout.
Tighten with wrench as needed.

Connect the hoses to the supply lines.
The left hose (marked with red band) connects to the hot water supply. The right hose connects to the cold water supply.

Tighten with wrench as needed.

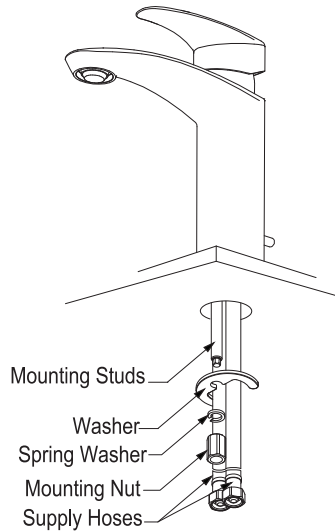
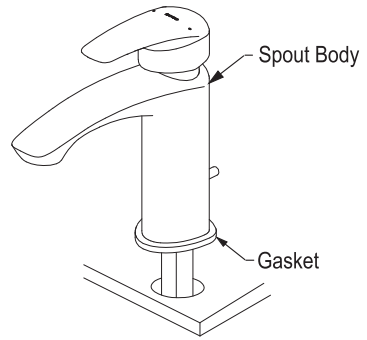

INSTALLATION PROCEDURE

Drain

(1) Package status of drain assembly

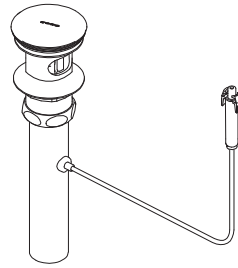

(2) Disassembling of drain
Please disassemble the drain into Part A, B and C as shown in the figure.

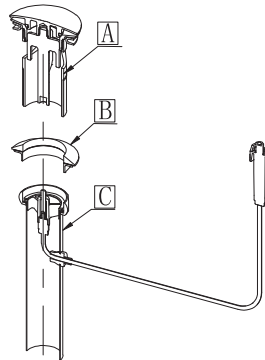

(3) Put Part A from above the drain port of the lavatory.

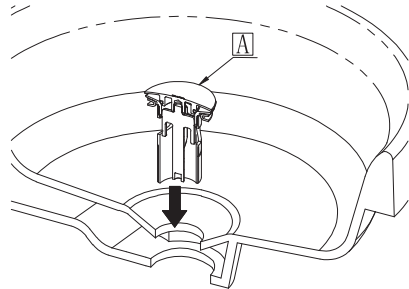

INSTALLATION PROCEDURE

ENGLISH

(4) Screw Part B from the bottom of the lavatory into Part A, turn the nut until the upper end of Part B is secured to the lavatory.
※Please don't forget the gasket in the middle of Part B.

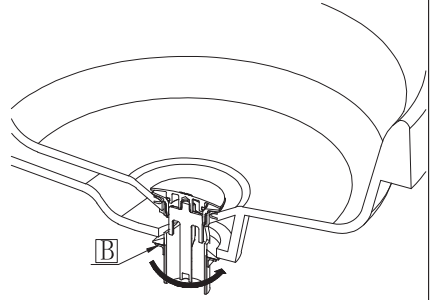

(5) After the nut of Part C is aligned with the lower end thread of Part A, turn the nut in Part C until it is tightened.

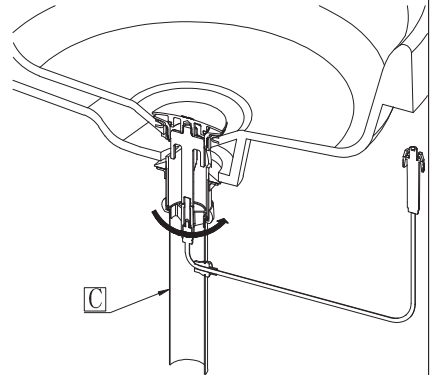

(6) Connecting part installation (as shown in the figure)

- User shall buckle the wire head of the drain assembly into the bottom of the lifting guide sleeve.
- Until it clicks.

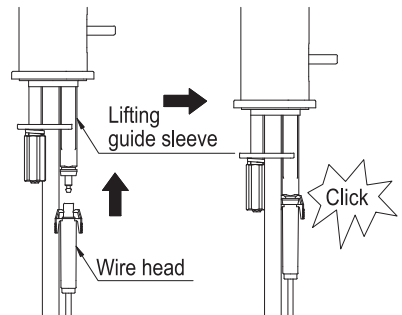

Note: Do not push it with force to avoid any damage.

INSTALLATION PROCEDURE

(7) Press the drain lift rod until it clicks.

※Check if it is well installed:

Press the drain lift rod and the cover part will pop up, then pull the drain lift rod again and the cover part will closed to stop the water.

Note: Do not press it with force to avoid any damage.

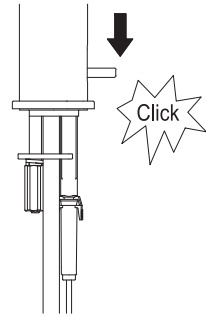

※The minimum bending radius of the drain rubber wire is R30mm.

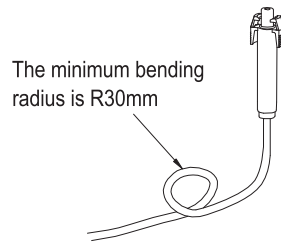

WARRANTY

TOTO U.S.A., INC. LIMITED LIFETIME WARRANTY

1. TOTO warrants its residential faucets and bathroom accessories ("Product") to be free from defects in materials and workmanship during normal use when properly installed and serviced, for the lifetime of the Product from date of purchase. This limited warranty is extended only to the ORIGINAL PURCHASER of the Product and is not transferable to any third party, including but not limited to any subsequent purchaser or owner of the Product. This warranty applies only to TOTO Product purchased and installed in North, Central and South America.
2. TOTO's obligations under this warranty are limited to repair, replacement or other appropriate adjustment, at TOTO's option, of the Product or parts found to be defective in normal use, provided that such Product was properly installed, used and serviced in accordance with instructions. TOTO reserves the right to make such inspections as may be necessary in order to determine the cause of the defect. TOTO will not charge for labor or parts in connection with warranty repairs or replacements. TOTO is not responsible for the cost of removal, return and/or reinstallation of the Product.
3. This warranty does not apply to the following items:
- a. Damage or loss sustained in a natural calamity such as fire, earthquake, flood, thunder, electrical storm, etc.
 - b. Damage or loss resulting from any accident, unreasonable use, misuse, abuse, negligence, or improper care, cleaning, or maintenance of the Product.
 - c. Damage or loss resulting from sediments or foreign matter contained in a water system.
 - d. Damage or loss resulting from improper installation or from installation of the Product in a harsh and/or hazardous environment, or improper removal, repair or modification of the Product.
 - e. Damage or loss resulting from electrical surges or lightning strikes or other acts which are not the fault of TOTO or which the Product is not specified to tolerate.
 - f. Damage or loss resulting from normal and customary wear and tear, such as gloss reduction, scratching or fading over time due to use, cleaning practices or water or atmospheric conditions, including but not limited to, the use of bleach, alkali, acid cleaners, dry (powder) cleaners or any other abrasive cleaners or the use of metal or nylon scrubbers.
4. In order for this limited warranty to be valid, proof of purchase is required. TOTO encourages warranty registration upon purchase to create a record of Product ownership at <http://www.totousa.com>. Product registration is completely voluntary and failure to register will not diminish your limited warranty rights.
5. If the Product is used commercially or is installed outside of North, Central or South America, TOTO warrants the Product to be free from defects in materials and workmanship during normal use for one (1) year from the date of installation of the Product, and all other terms of this warranty shall be applicable except the duration of the warranty.
6. THIS WARRANTY GIVES YOU SPECIFIC LEGAL RIGHTS. YOU MAY HAVE OTHER RIGHTS WHICH VARY FROM STATE TO STATE, PROVINCE TO PROVINCE OR COUNTRY TO COUNTRY.
7. To obtain warranty repair service under this warranty, you must take the Product or deliver it prepaid to a TOTO service facility together with proof of purchase (original sales receipt) and a letter stating the problem, or contact a TOTO distributor or products service contractor, or write directly to TOTO U.S.A., INC., 1155 Southern Road, Morrow, GA 30260 (888) 295 8134 or (678) 466-1300, if outside the U.S.A. If, because of the size of the Product or nature of the defect, the Product cannot be returned to TOTO, receipt by TOTO of written notice of the defect together with proof of purchase (original sales receipt) shall constitute delivery. In such case, TOTO may choose to repair the Product at the purchaser's location or pay to transport the Product to a service facility.

THIS WRITTEN WARRANTY IS THE ONLY WARRANTY MADE BY TOTO. REPAIR, REPLACEMENT OR OTHER APPROPRIATE ADJUSTMENT AS PROVIDED UNDER THIS WARRANTY SHALL BE THE EXCLUSIVE REMEDY AVAILABLE TO THE ORIGINAL PURCHASER. TOTO SHALL NOT BE RESPONSIBLE FOR LOSS OF THE PRODUCT OR FOR OTHER INCIDENTAL, SPECIAL OR CONSEQUENTIAL DAMAGES OR EXPENSES INCURRED BY THE ORIGINAL PURCHASER, OR FOR LABOR OR OTHER COSTS DUE TO INSTALLATION OR REMOVAL, OR COSTS OF REPAIRS BY OTHERS, OR FOR ANY OTHER EXPENSE NOT SPECIFICALLY STATED ABOVE. IN NO EVENT WILL TOTO'S RESPONSIBILITY EXCEED THE PURCHASE PRICE OF THE PRODUCT. EXCEPT TO THE EXTENT PROHIBITED BY APPLICABLE LAW, ANY IMPLIED WARRANTIES, INCLUDING THAT OF MERCHANTABILITY OR FITNESS FOR USE OR FOR A PARTICULAR PURPOSE, ARE EXPRESSLY DISCLAIMED. SOME STATES DO NOT ALLOW LIMITATIONS ON HOW LONG AN IMPLIED WARRANTY LASTS, OR THE EXCLUSION OR LIMITATION OF INCIDENTAL OR CONSEQUENTIAL DAMAGES, SO THE ABOVE LIMITATION AND EXCLUSION MAY NOT APPLY TO YOU.

ROUGH-IN DIMENSIONS / BOSQUEJO ROBINETTERIE BRUTE / DIMENSÕES APROXIMADAS

GE Single Handle Lavatory Faucet

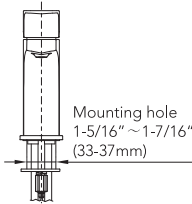
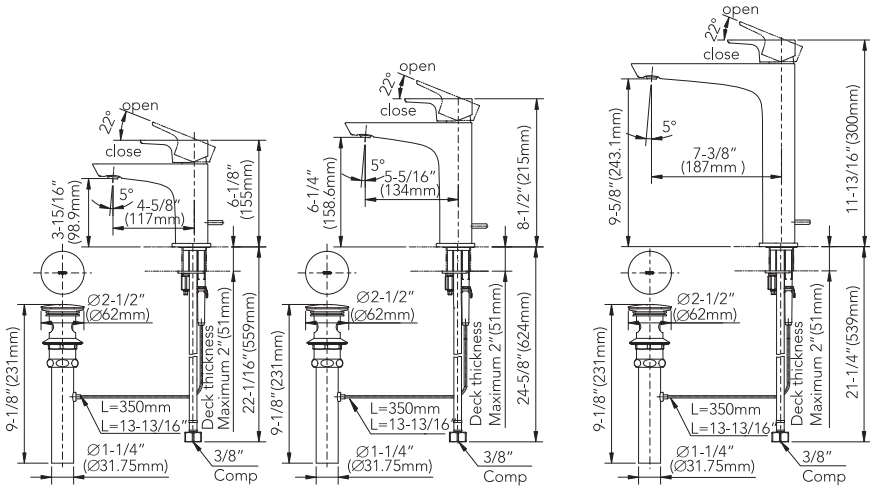
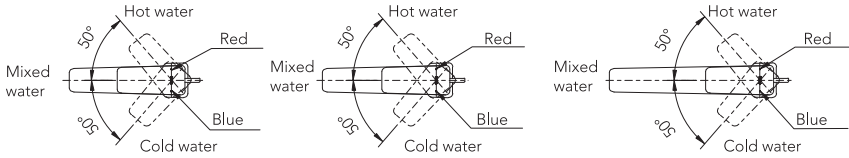

TLG07301U

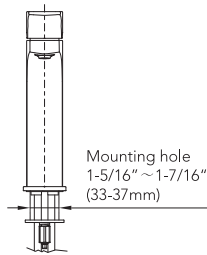

TLG07303U

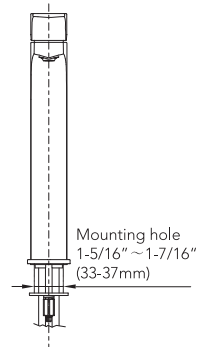

TLG07305U

NOTE: The above dimensional unit is inch.
The dimension in () is reference mm.

ROUGH-IN DIMENSIONS / BOSQUEJO ROBINETTERIE BRUTE / DIMENSÕES APROXIMADAS

GC Single Handle Lavatory Faucet

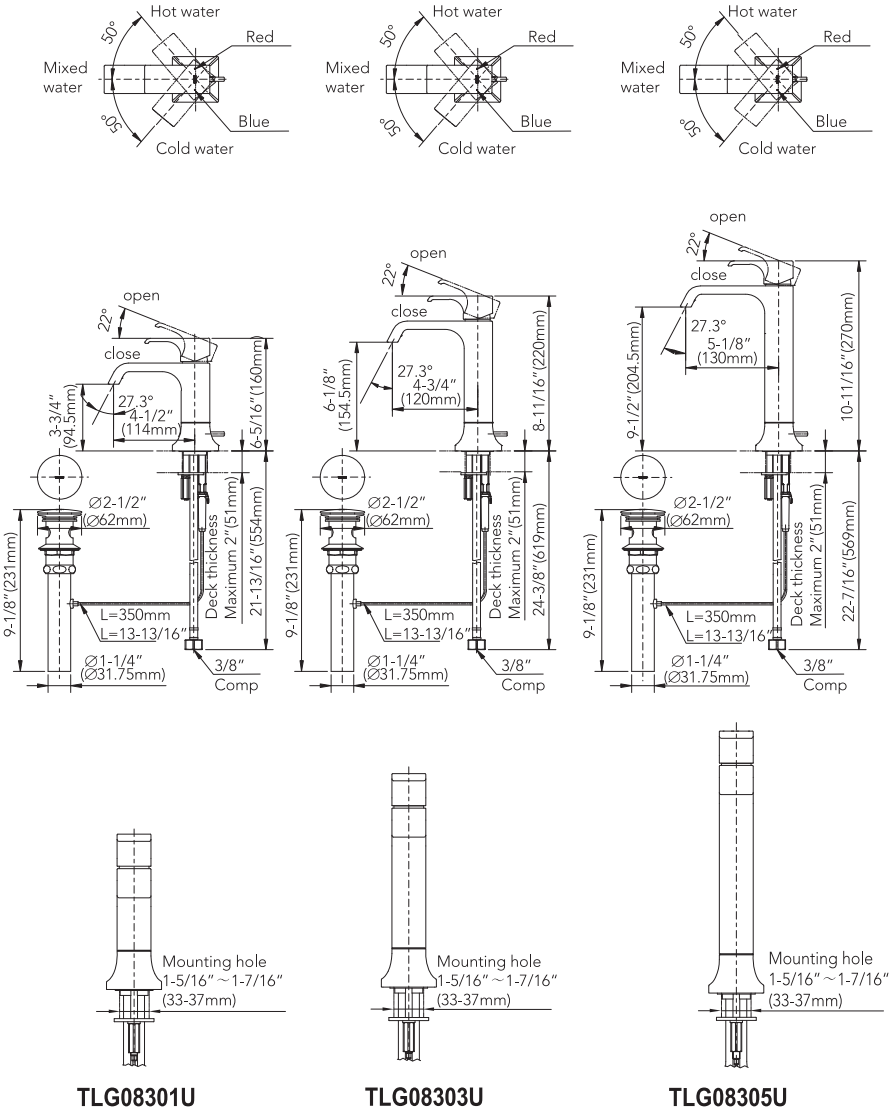

NOTE: The above dimensional unit is inch.
The dimension in () is reference mm.

ROUGH-IN DIMENSIONS / BOSQUEJO ROBINETTERIE BRUTE / DIMENSÕES APROXIMADAS

GM Single Handle Lavatory Faucet

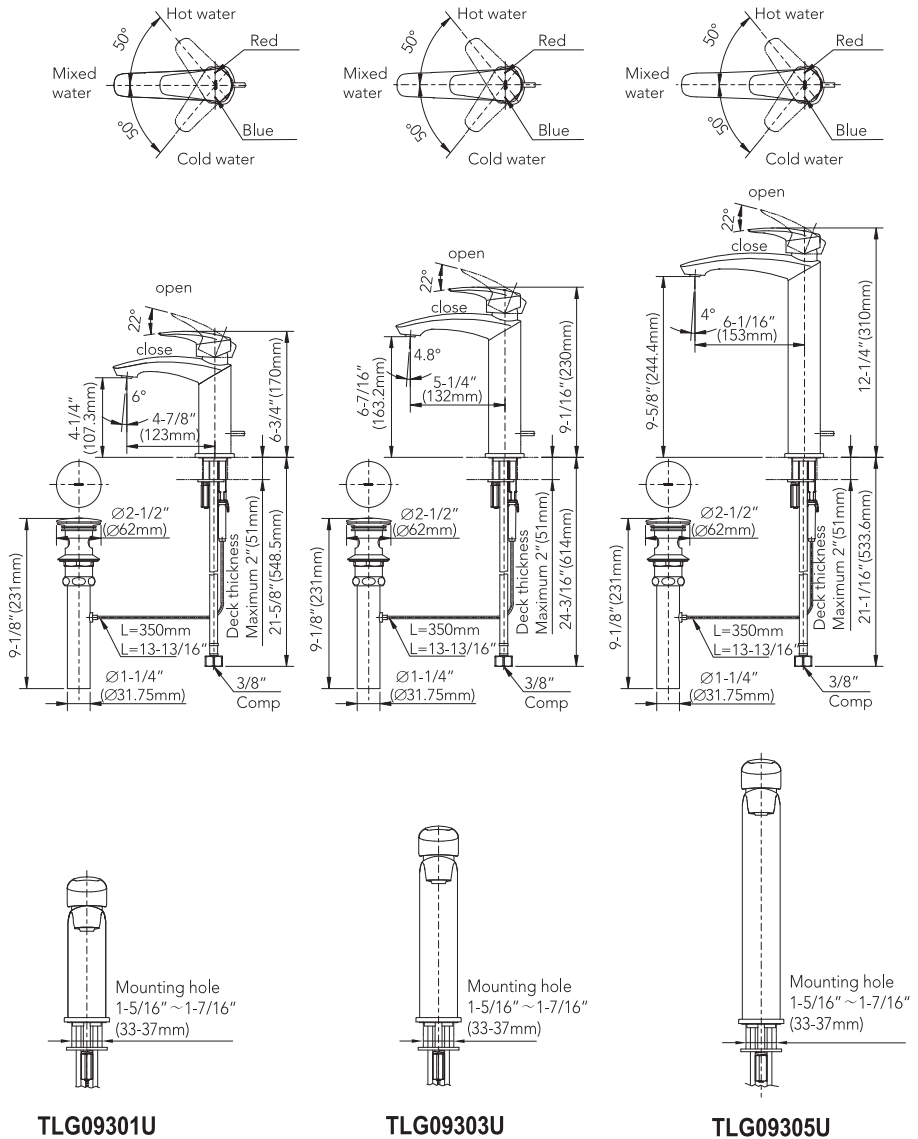

NOTE: The above dimensional unit is inch.
The dimension in () is reference mm.

ROUGH-IN DIMENSIONS / BOSQUEJO ROBINETTERIE BRUTE / DIMENSÕES APROXIMADAS

GB Single Handle Lavatory Faucet

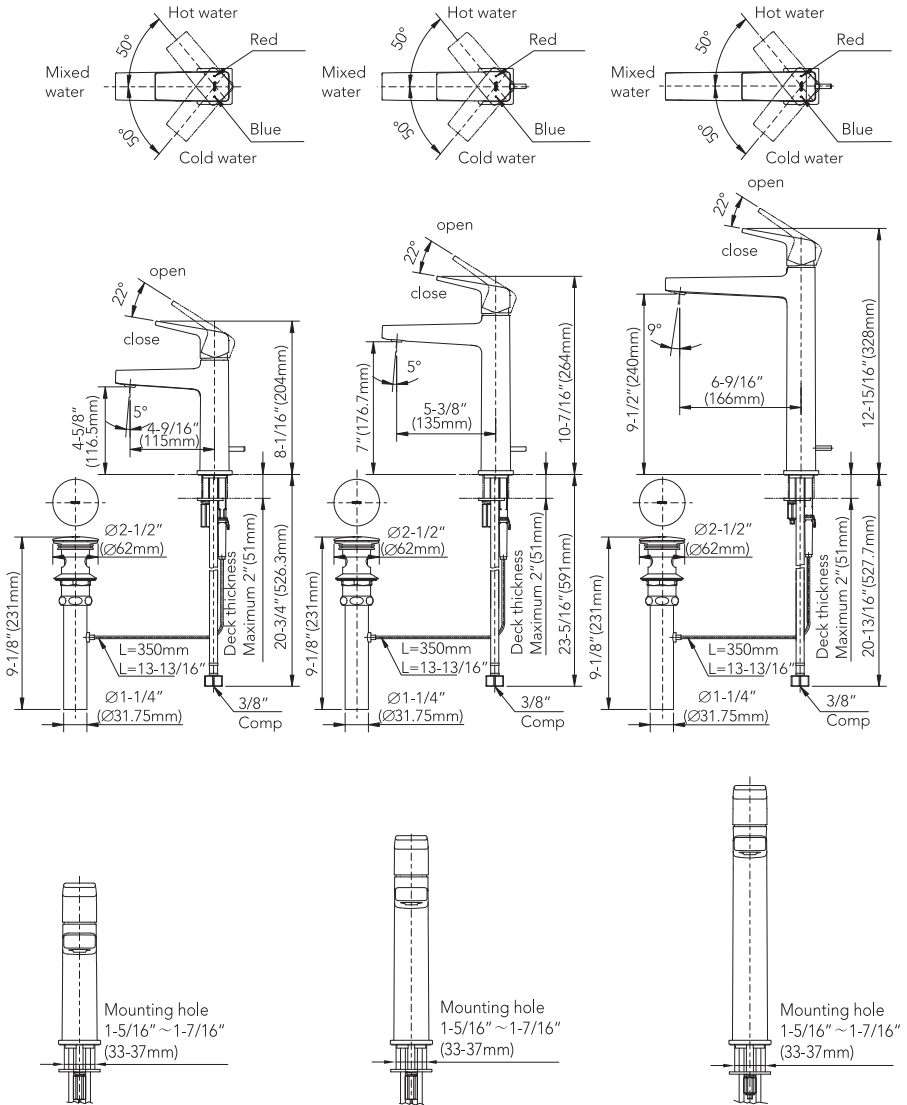

TLG10301U

TLG10303U

TLG10305U

NOTE: The above dimensional unit is inch.
The dimension in () is reference mm.

ROUGH-IN DIMENSIONS / BOSQUEJO ROBINETTERIE BRUTE / DIMENSÕES APROXIMADAS

GF Single Handle Lavatory Faucet

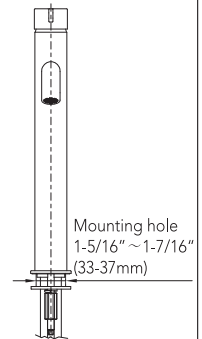
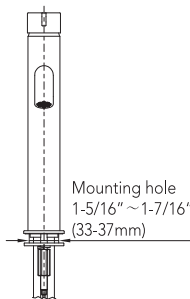
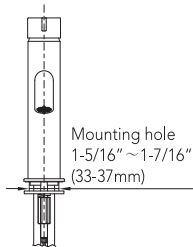
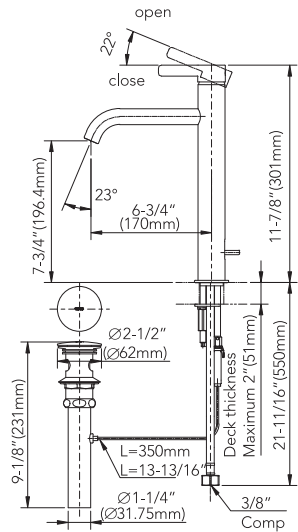
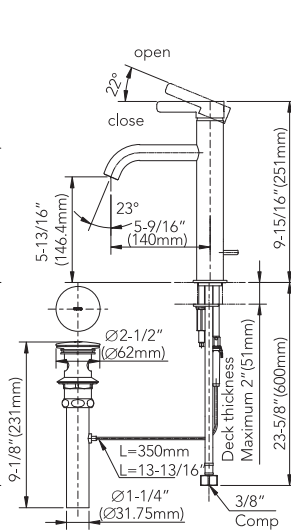
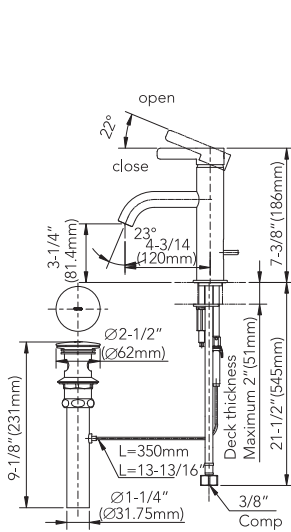
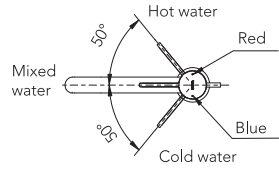
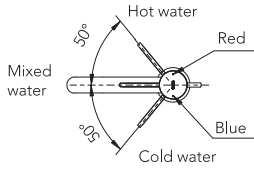
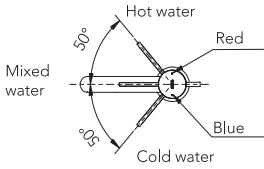

TLG11301U

TLG11303U

TLG11305U

NOTE: The above dimensional unit is inch.
The dimension in () is reference mm.

NOTES

TOTO

TOTO U.S.A., Inc. 1155 Southern Road,
Morrow, Georgia 30260
Tel: 888-295-8134 Fax: 800-699-4889
www.totousa.com

0GU4305
Rev A



Warranty Registration and Inquiry

For product warranty registration, TOTO U.S.A. Inc. recommends online warranty registration. Please visit our web site <http://www.totousa.com>. If you have questions regarding warranty policy or coverage, please contact TOTO U.S.A. Inc., Customer Service Department, 1155 Southern Road, Morrow, GA 30260 (888) 295-8134 or (678) 466-1300 when calling from outside of U.S.A.