

Attention Installer:

- Elkay recommends that drop-in sinks be installed by a professional, experienced installer.
- Elkay is not responsible for the sink or countertop if damaged during installation.
- Metal edges may be sharp. Use caution when handling.
- Follow all local plumbing and building codes.
- Inspect sink for damage prior to beginning installation.

Required Tools (not included)

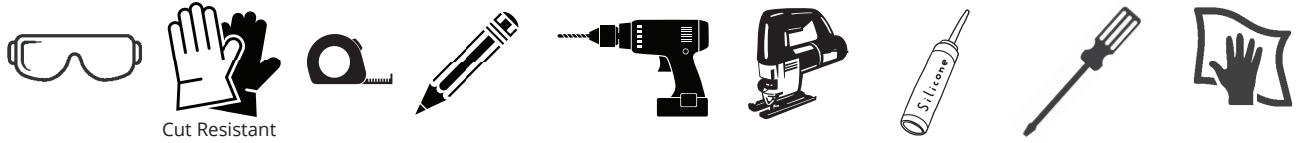

Cut Resistant

Installation



WARNING: Always wear safety goggles and gloves when using power tools or handling the sink to prevent personal injury.

- 1** Position the sink upside down on the countertop.

Trace a line around the edge of the sink.

Draw a line 5/16" inside of the outline of the sink.

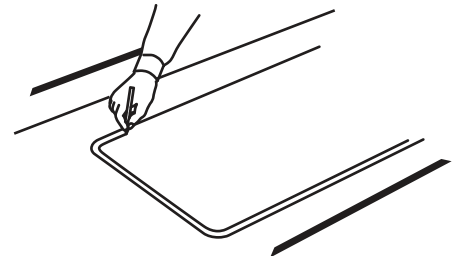
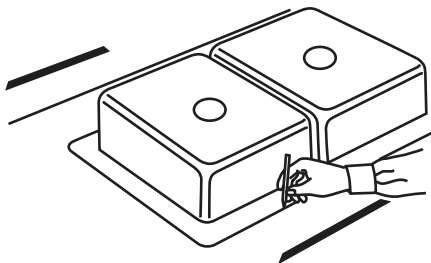

- 2** Drill a pilot hole in all four corners of the inside line.

Use a saber or jig saw to cut on the inside line.

Place a support underneath the cutout portion of the countertop to prevent it from falling during cutting.

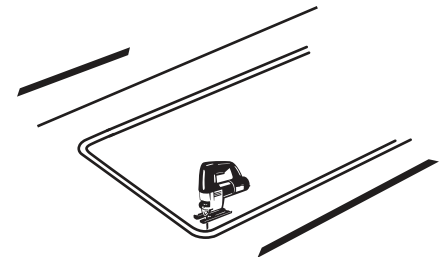
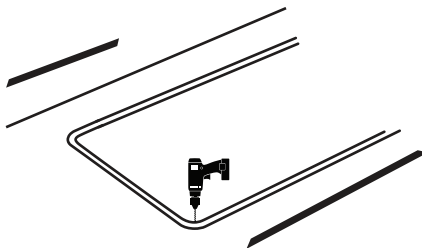

- 3** Apply silicone caulk (not included) around the cutout in the countertop surface.

Carefully lower the sink into the cutout.

Assemble the clips and screws.

From the underside, place a clip in the center along each side and hand tighten to hold sink in place. Fasten the remaining clips along the edges and space them approximately 3" from each end, and equally along the front, back, and sides. For countertops thicker than 3/4", clips can be spaced as close as 1-1/2".

From the top, check the seal between the sink edge and countertop. Lightly tighten clips evenly with a screwdriver until the sink is tight to the countertop. Do not over tighten.

Wipe away any excess caulk with a rag.

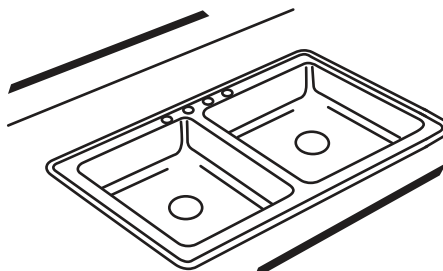
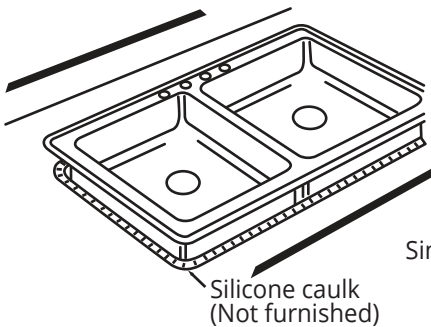

Installation Profile

