

## Push, Pull, Pedal Push and Pedal Handle Push Button

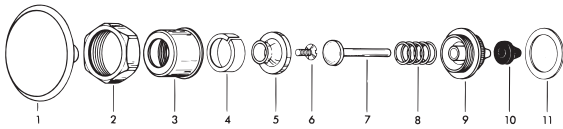

### 3" Push Button For Exposed Royal® & Crown®

Item			
No.	Code No.	Part No.	Description
<b>Repair Kits</b>			
	<b>3303396</b>	C-64-A	Push Button Repair Kit contains item nos. 7-11
	<b>3303347</b>	C-1000-A	Replacement Kit contains item nos. 1,5 & 6
<b>Repair Parts</b>			
1-11.	<b>0303351</b>	C-42-A	Push Button Assembly
1.	*	C-42	3" Push Button CP
2.	<b>0301082</b>	A-6	CP Coupling
3-4.	<b>0302109</b>	B-7-A	Socket
5.	*	C-41	Shank Head
6.	*	C-43	Screw RB
7.	*	B-8-A	Plunger
8.	<b>0303019</b>	C-7	Spring
9.	*	B-49	Bushing
10.	<b>5302297</b>	B-39	Seal
11.	<b>5301139</b>	A-31	Gasket

\*Available in kit only.

### Push Button For Concealed Royal® & Crown®

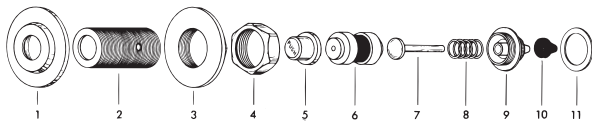

Item			
No.	Code No.	Part No.	Description
<b>Repair Kits</b>			
	—	C-9-A	Complete Push Button Assembly. Items 1-11. Consult factory.
	<b>3303399</b>	C-77-A	Push Button Repair Kit contains item nos. 7-11
<b>Repair Parts</b>			
1.	<b>0302248</b>	B-23	CP Wall Flange 2-3/4" O.D.
	<b>0302252</b>	B-23	CP Wall Flange 2-3/4" O.D. w/Set Screw for Wall Box Installation †
2.	—	B-6/B-6-A	In-Wall Sleeve. If required, consult factory.
3.	<b>0302260</b>	B-24	RB Locknut
4.	<b>0301082PO</b>	A-6	RB Coupling
5.	<b>0303002</b>	C-2	Index Push Button
6.	—	B-15-A	N/A. Multiple lengths available. Consult factory.
7.	*	B-8-A	Plunger
8.	*	C-7	Spring
9.	*	B-41	Bushing
10.	—	B-85	Permex® Seal
11.	<b>5301139</b>	A-31	Gasket

\*Available in kit only. †Wall Box Assembly for C-43-AWB/C-9-AWB/B-12-AWB

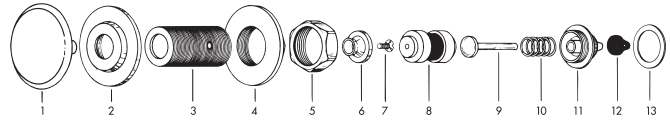

### 3" Push Button For Concealed Royal® & Crown®

Item			
No.	Code No.	Part No.	Description
<b>Repair Kits</b>			
	—	C-43-A	3" Push Button Assembly. Items 1-13. Consult factory.
	<b>3303398</b>	C-70-A	Push Button Repair Kit contains item nos. 9-13*
	<b>3303399</b>	C-77-A	Push Button Repair Kit contains item nos. 9-13 – Triple Seal Cone Seal*
	<b>3303347</b>	G-1000-A	Replacement Kit contains item nos. 1,6 & 7
<b>Repair Parts</b>			
1.	*	C-42	3" Push Button CP
2.	<b>0302248</b>	B-23	CP Wall Flange 2-3/4" O.D.
	<b>0302252</b>	B-23	CP Wall Flange 2-3/4" O.D. w/Set Screw for Wall Box Installation †
3.	—	B-6/B-6-A	In-Wall Sleeve. If required, consult factory.
4.	<b>0302260</b>	B-24	RB Locknut
5.	<b>0301083</b>	A-6	RB Coupling
6.	*	C-41	Shank Head
7.	*	C-43	RB Screw
8.	—	B-15-A	N/A. Multiple lengths available. Consult factory.
9.	*	B-8-A	Plunger
10.	<b>0303019</b>	C-7	Spring
11.	*	B-41	Bushing
12.	<b>5302297</b>	B-39	Seal
13.	<b>5301139</b>	A-31	Gasket

\*Available in kit only.

### Pull Button For Exposed Royal® & Crown® (Seat Action)

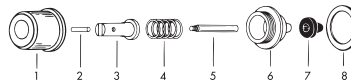

Item			
No.	Code No.	Part No.	Description
<b>Repair Kit</b>			
	<b>3303393</b>	C-61-A	Repair Kit contains item nos. 4-9
<b>Repair Parts</b>			
1.	<b>0303174</b>	C-25	Socket
2.	<b>5303213</b>	C-29	RB Pin
3.	<b>0303155</b>	C-23	CP Plunger Sleeve
4.	*	C-28	Spring
5.	*	C-24	Plunger Stem
6.	*	C-61	Bushing
7.	<b>5302297</b>	B-39	Seal
8.	<b>5301139</b>	A-31	Gasket

\*Available in kit only.

## Push, Pull, Pedal Push and Pedal Handle Push Button

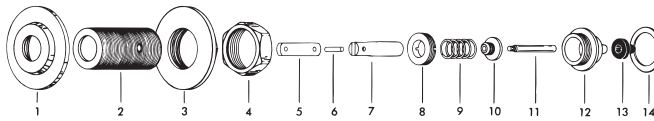

### Pull Button For Concealed Royal® & Crown® (Seat Action)

Item			
No.	Code No.	Part No.	Description
<b>Repair Kit</b>			
	<b>3303394</b>	C-62-A	Repair Kit contains item nos. 9-14
<b>Repair Parts</b>			
1.	<b>0302248</b>	B-23	CP Wall Flange 2-3/4" O.D.
2.	—	C-30	In-Wall Sleeve. If required, consult factory.
3.	<b>0302260</b>	B-24	RB Locknut
4.	<b>0301083</b>	A-6	RB Coupling
5.	—	C-27	Link Available in Multiple Lengths. Consult factory.
6.	<b>5303213</b>	C-29	RB Pin
7.	—	C-31	Sleeve Available in Multiple Lengths. Consult factory.
8.	<b>0203013</b>	C-48	RB Sleeve Guide
9.	*	C-28	Spring
10.	*	C-32	Plunger Head
11.	*	C-24	Plunger Stem
12.	*	C-61	Special Bushing
13.	<b>5302297</b>	B-39	Seal
14.	<b>5301139</b>	A-31	Gasket

\*Available in kit only.

### Pedal Push Button For Exposed Royal® & Crown®

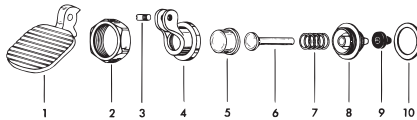

Item			
No.	Code No.	Part No.	Description
<b>Repair Kit</b>			
	<b>3302304</b>	B-40-A	Repair Kit contains item nos. 4-10
<b>Repair Parts</b>			
1-10.	<b>0303289</b>	C-33-A	Pedal RB Assembly
1.	<b>0303293</b>	C-34	CP Pedal
2.	<b>0301082</b>	A-6	Coupling
3.	<b>5303298</b>	C-35	CP Screw
4.	*	C-33	CP Socket
5.	*	C-37	CP Push Button
6.	*	B-8-A	Plunger (Special)
7.	<b>0303019</b>	C-7	Spring
8.	*	B-49	Bushing
9.	<b>5302297</b>	B-39	Seal
10.	<b>5301140</b>	A-31-P	Gasket

\*Available in kit only.

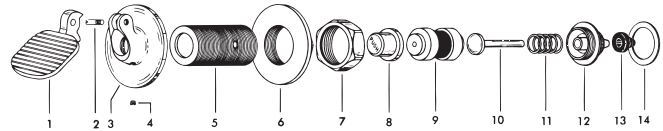

### Pedal Push Button For Concealed Royal® & Crown®

Item			
No.	Code No.	Part No.	Description
<b>Repair Kit</b>			
	—	C-40-A	Complete Pedal Push Button Assembly item nos. 1-14 LDIM required
	<b>3303398</b>	C-70-A	Push Button Repair Kit contains item nos. 10-14
	<b>3303399</b>	C-77-A	Push Button Repair Kit contains item nos. 10-14 – Triple Seal Cone Seal
<b>Repair Parts</b>			
1.	<b>0303293</b>	C-34	CP Pedal
2.	<b>5303298</b>	C-35	CP Screw
3-4.	<b>0303303</b>	C-40	CP Flange w/Set Screw
5.	—	B-6	In-Wall Sleeve. If required, consult factory.
6.	<b>0302260</b>	B-24	RB Locknut
7.	<b>0301082PO</b>	A-6	RB Coupling
8.	<b>0303002</b>	C-2	Index Push Button
9.	—	B-15-A	N/A. Multiple lengths available. Consult factory.
10.	*	B-8-A	Plunger
11.	<b>0303019</b>	C-7	Spring
12.	*	B-41	Bushing
13.	<b>5302297</b>	B-39	Seal
14.	<b>5301139</b>	A-31	Gasket

\*Available in kit only.

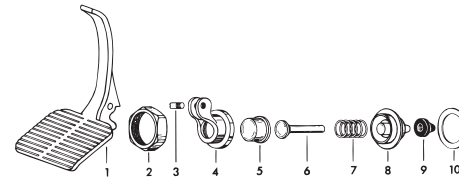

### Pedal Handle Push Button For Exposed Royal® & Crown®

Item			
No.	Code No.	Part No.	Description
<b>Repair Kit</b>			
	<b>3302304</b>	B-40-A	Repair Kit contains item nos. 4-10
<b>Repair Parts</b>			
1-10.	<b>0303290</b>	C-33-A	Pedal Handle PB Assembly – <b>OBSOLETE</b>
1.	<b>0303295</b>	C-34	CP Pedal Handle – <b>OBSOLETE</b>
2.	<b>0301082</b>	A-6	Coupling
3.	<b>5303298</b>	C-35	CP Screw
4.	*	C-33	CP Socket
5.	*	C-37	CP Push Button
6.	*	B-8-A	Plunger (Special)
7.	<b>0303019</b>	C-7	Spring
8.	*	B-49	Bushing
9.	<b>5302297</b>	B-39	Seal
10.	<b>5301140</b>	A-31-P	Gasket

\*Available in kit only.

## Push, Pull, Pedal Push and Pedal Handle Push Button

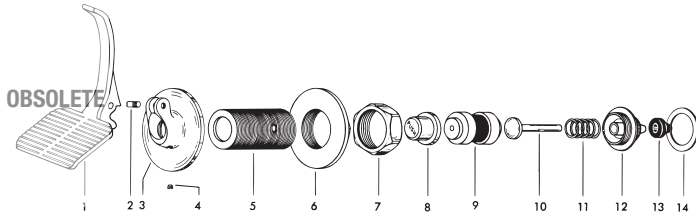

**Pedal Handle Push Button For Concealed Royal® & Crown®**

Item No.	Code No.	Part No.	Description
<b>Repair Kit</b>			
—	C-40-A	Complete Pedal Handle Push Button Assembly. Items 1-14. Consult factory – <b>OBSOLETE</b>	

<b>Repair Parts</b>			
1.	<b>0303295</b>	C-34	CP Pedal Handle – <b>OBSOLETE</b>
2.	<b>5303298</b>	C-35	CP Screw
3-4.	<b>0303303</b>	C-40	CP Flange w/Set Screw
5.	—	B-6/B-6-A	In-Wall Sleeve. If required, consult factory.
6.	<b>0302260</b>	B-24	RB Locknut
7.	<b>0301082PO</b>	A-6	RB Coupling
8.	<b>0303002</b>	C-2	Index Push Button
9.	—	B-15	N/A. Multiple lengths available. Consult factory.
10.	*	B-8-A	Plunger
11.	<b>0303019</b>	C-7	Spring
12.	*	B-41	Bushing
13.	<b>5302297</b>	B-39	Seal
14.	<b>5301139</b>	A-31	Gasket

\*Available in kit only.

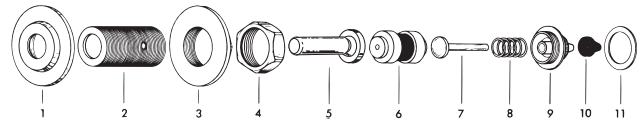

**Handle For Concealed Royal® & Crown®**

Item No.	Code No.	Part No.	Description
<b>Repair Kit</b>			
<b>3303398</b>	C-70-A	CP ADA-Compliant Triple Seal Handle Assembly	

<b>Repair Parts</b>			
1.	<b>0302248</b>	B-23	CP Wall Flange 2-3/4" O.D.
	<b>0302252</b>	B-23	CP Wall Flange 2-3/4" O.D. w/Set Screw for Wall Box Installation †
2.	—	B-6/B-6-A	In-Wall Sleeve. If required, consult factory.
3.	<b>0302260</b>	B-24	RB Locknut
4.	<b>0301082PO</b>	A-6	RB Coupling
5.	<b>0302389</b>	B-74-A	CP ADA-Compliant Handle
6.	—	B-15-A	N/A. Multiple lengths available. Consult factory.
7.	*	B-8-A	Plunger
8.	*	C-7	Spring
9.	*	B-41	Bushing
10.	<b>5302297</b>	B-39	Seal
11.	<b>5301139</b>	A-31	Gasket

\*Available in kit only. †Wall Box Assembly for C-43-AWB/C-9-AWB/B-12-AWB

**"L" Dimension PUSH BUTTON ID CHART** (All dimensions in inches)

Wall Thickness	1	2	3	4	5	6	7	8	9	10	11	12	13	14	15
"L" Dimension	3 3/4	4 3/4	5 3/4	6 3/4	7 3/4	8 3/4	9 3/4	10 3/4	11 3/4	12 3/4	13 3/4	14 3/4	15 3/4	16 3/4	17 3/4
"A" (B-15-A) Filler Rod	1 5/8	2 5/8	3 5/8	4 5/8	5 5/8	6 5/8	7 5/8	8 5/8	9 5/8	10 5/8	11 5/8	12 5/8	13 5/8	14 5/8	15 5/8
"B" (B-6-A) Socket Assembly	2 1/2	3 1/2	4 1/2	5 1/2	6 1/2	7 1/2	8 1/2	9 1/2	10 1/2	11 1/2	12 1/2	13 1/2	14 1/2	15 1/2	16 1/2

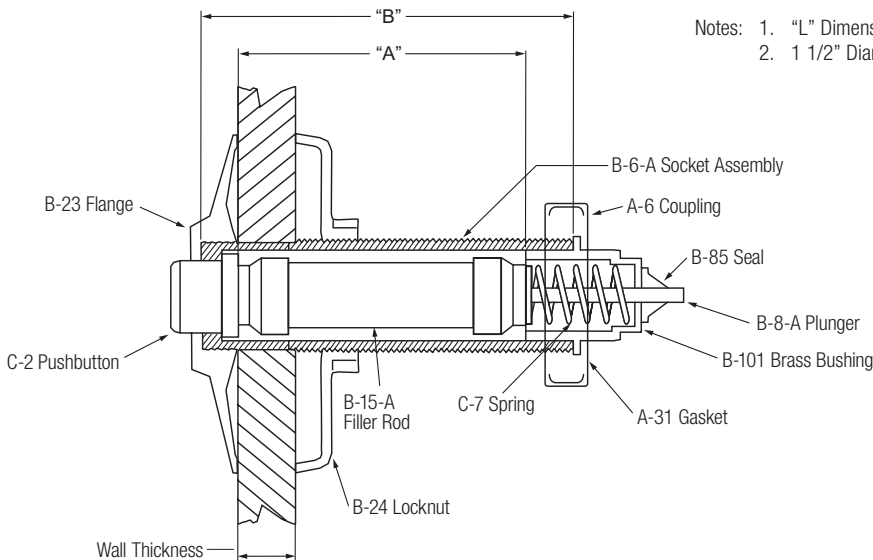

Notes: 1. "L" Dimension = Wall thickness (to nearest whole inch) + 2 3/4"  
 2. 1 1/2" Diameter Hole Opening Required Through Wall

