

SUBMITTAL DATA

3VIR09HP230V1AH & BH¹ for Use with Multi GEN2 and Multi+ Ultra
9000 BTU/H Wall Mounted Unit

Job Name <input type="text"/>	Location <input type="text"/>	Date <input type="text"/>
Purchaser <input type="text"/>	Engineer <input type="text"/>	
Submitted to <input type="text"/>	For <input type="text"/>	
Unit Designation <input type="text"/>	Schedule No. <input type="text"/>	



YAP1F7F



3VIR09HP230V1AH & BH¹



XE71 (Optional)

GENERAL FEATURES

- High Efficiency DC Inverter Technology
- Compact and Quiet Design
- Auto-Clean Function on Indoor Unit
- Wireless Remote with LCD Display
- Wired Controller Options
- Wi-Fi Included (Factory Installed)
- Low Ambient Cooling Based on Outdoor Unit Performance
- Low Ambient Heating Based on Outdoor Unit Performance
- Coil (Indoor and Outdoor) Copper Tube / Aluminum Fin
- Blue Colored Fin - 500 Hrs Salt Spray Tested

SPECIFICATIONS, FEATURES & FUNCTION SUMMARY

SPECIFICATIONS		3VIR09HP230V1AH & BH ¹		FEATURES & FUNCTIONS SUMMARY		3VIR09HP230V1AH & BH ¹		
System Type		HEAT PUMP						
SYSTEM PERFORMANCE				SYSTEM FEATURES				
Cooling	Nominal	Btu/h	9100	Wired Controller Interface (XE71)	Yes			
	Capacity @95°F	Btu/h		WiFi Included	Yes			
Heating	Nominal	Btu/h	11000	NEW! Easy Service Access	Yes			
	Capacity @5°F	Btu/h		Indoor Fan Type	Crossflow			
	Capacity @17°F	Btu/h		Multi Fan Speeds	7 Speeds			
	Capacity @47°F	W		Indoor Unit Display	Yes			
SEER2				Auxiliary Electrical Heater	No			
EER2				Ventilation (Outdoor Air)	No			
HSPF2				REMOTE CONTROLLER FUNCTIONS				
COP @5°F	System Performance Based on the Connected Outdoor Unit Performance			NEW! Auto Clean	Yes			
COP @47°F				Auto Mode	Yes			
Cooling Temperature Range				°F	Auto Fan	Yes		
Heating Temperature Range				°F	Auto Swing (Horizontal Auto Swing)	Yes		
Refrigerant Type					R410A	Auto Swing - 180° (Vertical Auto Swing)	Yes	
INDOOR UNIT		3VIR09HP230V1AH & BH¹		Clock	Yes			
Air flow (Min-Max)	CFM	159 - 353		Dry Mode	Yes			
Sound Pressure Level (Min - Max)	dB(A)	25 - 40		Dry Anti-Mildew (X-Fan) Mode	Yes			
Dehumidification	pt/hr	1.69		Energy Saving Mode	Yes			
External Dimensions (WxHxD)	in	32-1/2 x 11-9/16 x 7-3/4		Dirty Filter Alert	No			
Package Dimension (W x H x D)	in	34-7/16 x 14-3/8 x 10-9/16		Fan Speed Control (7 Speeds)	Yes			
Net Weight	lbs	20.9		I Feel Function	Yes			
Gross Weight	lbs	25.4		Privacy Lock	Yes			
REFRIGERANT PIPING				Quiet Mode	Yes			
Line Set Sized by the Indoor Unit (Liquid - Gas) - Flared Connections	in	1/4 - 3/8		Room Temperature Display	No			
ELECTRICAL				Sleep Mode	Yes			
Power Supply	208-230V / 1Ph / 60Hz (Powered by the Outdoor Unit)			3 Sleep Mode Options	Yes			
				Timer Mode	Yes			
				Turbo Mode	Yes			
				Display On/Off Control	Yes			
				Freeze Guard Mode	Yes			
				Power Failure Mode	Yes			

¹AH = MATT FINISH; BH = SMOOTH FINISH

DIMENSIONS & CLEARANCES

INDOOR UNIT

Unit: inch

3VIR09HP230V1AH & BH ¹	
DIMENSIONS	
W	32-31/64
H	11-17/32
D	7-23/32
W1	4-29/64
W2	21-11/32
W3	6-11/16

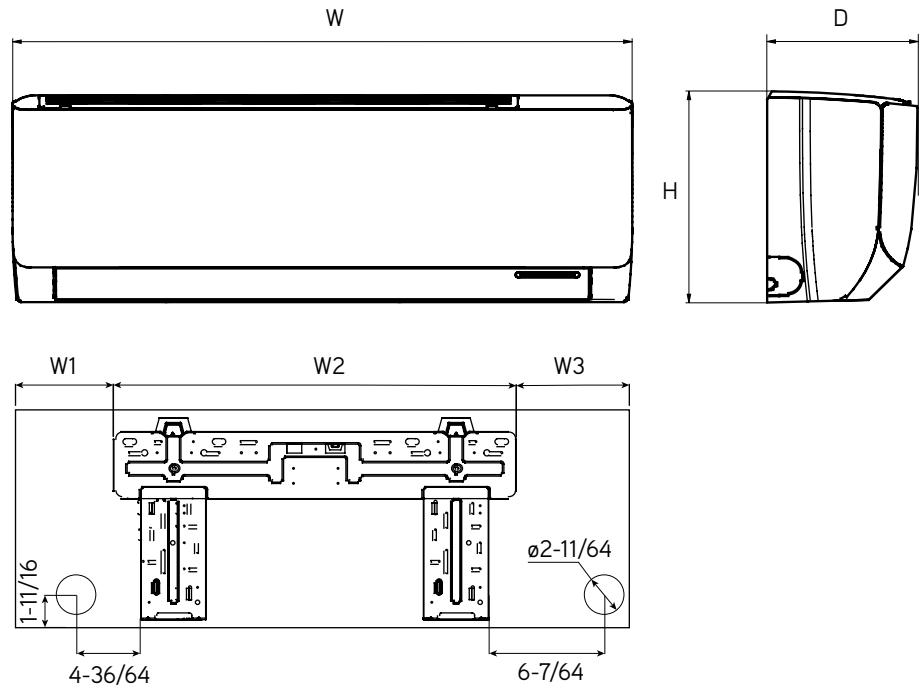

INDOOR UNIT

Minimum clearance

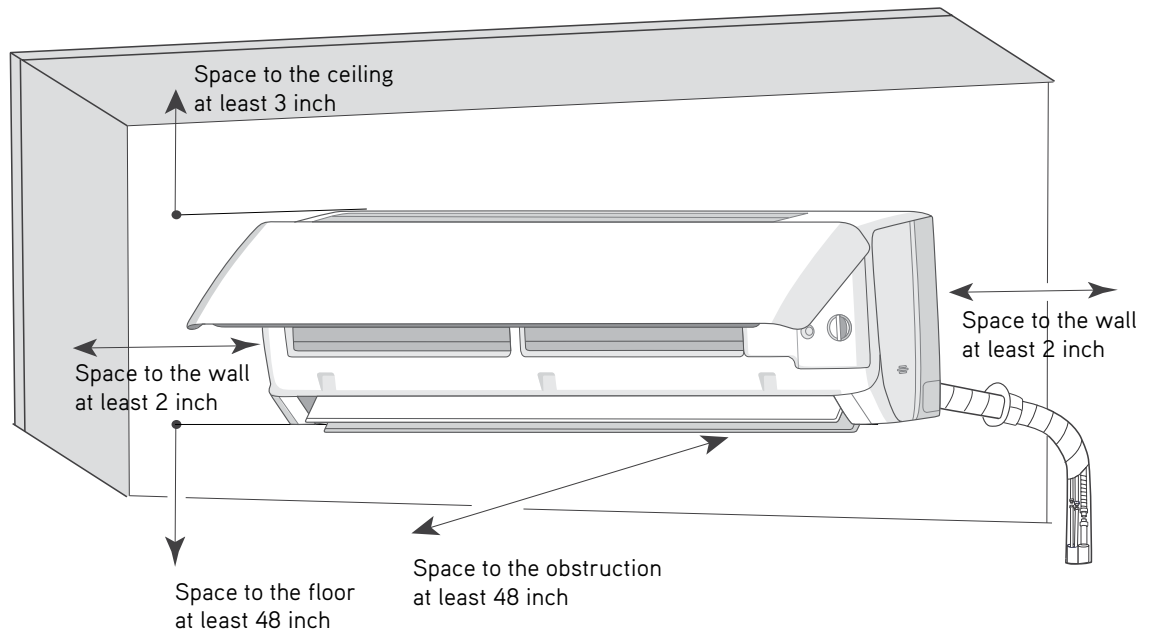

Specifications are subject to change without notice. Manufacturer reserves the right to discontinue or modify specifications or designs without notice or without incurring obligations. All Rights reserved.

GREECOMFORT.COM/SYSTEM-DOCUMENTATION