

ALPHA

Installation and operating instructions



ALPHA

English (US)

Installation and operating instructions	4
---	---

Original installation and operating instructions

Table of contents

1. Limited warranty	4
2. General information	5
2.1 Hazard statements	5
2.2 Notes	5
3. Product introduction	5
3.1 Product description	5
3.2 Intended use	5
3.3 Pumped liquids	6
3.4 Identification	6
3.5 Approvals	7
4. Receiving the product	7
4.1 Inspecting the product	7
4.2 Scope of delivery	7
5. Installation requirements	8
5.1 Radio frequency radiation exposure information (for Canada and US only) (only for ALPHA)	8
5.2 Optimal installation and operation	8
6. Mechanical installation	8
6.1 Mounting the product	8
6.2 Changing the control box position	9
7. Electrical connection	11
7.1 Wiring the pump	11
8. Starting up the product	12
8.1 Venting the pump	12
8.2 Dry-running protection	12
9. Control functions	13
9.1 Operating panel	13
9.2 Light fields indication	13
9.3 Control modes	14
10. Setting of the product	17
10.1 Connecting the product to Grundfos GO	17
10.2 Guided setup	17
10.3 Air detection and system venting	18
10.4 Flow limitation	18
10.5 Trend data	18
10.6 Updating the firmware	18
10.7 Resetting to factory settings	18
10.8 Settings according to system type	18
11. Service	19
11.1 Dismantling the product	19
12. Fault finding	20
12.1 Fault indication on the pump operating panel	20
12.2 Overview of alarm and warning codes	21
12.3 Resetting alarms and warnings manually with Grundfos GO	21
12.4 Alarm and warning code logs	21
12.5 Automatic deblocking	21
12.6 Overheated boiler	21
12.7 Noise in the system	21
12.8 Alarms	21
12.9 Warnings	22
13. Technical data	23
14. Disposing of the product	23
15. Document quality feedback	23

1. Limited warranty

Products manufactured by Grundfos Pumps Corporation (Grundfos) are warranted to the original user only to be free of defects in material and workmanship for a period of 24 months from date of installation, but not more than 30 months from date of manufacture. Grundfos' liability under this warranty shall be limited to repairing or replacing at Grundfos' option, without charge, F.O.B. Grundfos' factory or authorized service station, any product of Grundfos manufacture. Grundfos will not be liable for any costs of removal, installation, transportation, or any other charges that may arise in connection with a warranty claim. Products which are sold, but not manufactured by Grundfos, are subject to the warranty provided by the manufacturer of said products and not by Grundfos' warranty. Grundfos will not be liable for damage or wear to products caused by abnormal operating conditions, accident, abuse, misuse, unauthorized alteration or repair, or if the product was not installed in accordance with Grundfos' printed installation and operating instructions and accepted codes of good practice. The warranty does not cover normal wear and tear. To obtain service under this warranty, the defective product must be returned to the distributor or dealer of Grundfos' products from which it was purchased together with proof of purchase and installation date, failure date and supporting installation data. Unless otherwise provided, the distributor or dealer will contact Grundfos or an authorized service station for instructions. Any defective product to be returned to Grundfos or a service station must be sent freight prepaid; documentation supporting the warranty claim and/or a Return Material Authorization must be included if so instructed. Grundfos will not be liable for any incidental or consequential damages, losses, or expenses arising from installation, use, or any other causes. There are no express or implied warranties, including merchantability or fitness for a particular purpose, which extend beyond those warranties described or referred to above. Some jurisdictions do not allow the exclusion or limitation of incidental or consequential damages and some jurisdictions do not allow limitations on how long implied warranties may last. Therefore, the above limitations or exclusions may not apply to you. This warranty gives you specific legal rights and you may also have other rights which vary from jurisdiction to jurisdiction. Products which are repaired or replaced by Grundfos or authorized service center under the provisions of these limited warranty terms will continue to be covered by Grundfos warranty only through the remainder of the original warranty period set forth by the original purchase date.

2. General information



Read this document before you install the product. Installation and operation must comply with local regulations and accepted codes of good practice.

2.1 Hazard statements

The symbols and hazard statements below may appear in Grundfos installation and operating instructions, safety instructions and service instructions.



DANGER

Indicates a hazardous situation which, if not avoided, will result in death or serious personal injury.



WARNING

Indicates a hazardous situation which, if not avoided, could result in death or serious personal injury.



CAUTION

Indicates a hazardous situation which, if not avoided, could result in minor or moderate personal injury.

The hazard statements are structured in the following way:



SIGNAL WORD

Description of the hazard

Consequence of ignoring the warning

- Action to avoid the hazard.

2.2 Notes

The symbols and notes below may appear in Grundfos installation and operating instructions, safety instructions and service instructions.



Observe these instructions for explosion-proof products.



A blue or gray circle with a white graphical symbol indicates that an action must be taken.



A red or gray circle with a diagonal bar, possibly with a black graphical symbol, indicates that an action must not be taken or must be stopped.



If these instructions are not observed, it may result in malfunction or damage to the equipment.



Tips and advice that make the work easier.

3. Product introduction

3.1 Product description



TM082628

ALPHA 15-58

ALPHA is a high-efficiency circulator fitted with an electronically commutated motor and designed for circulating liquids in heating systems.

The pump features the highest HI energy rating on the market. ALPHA is designed with intelligent controls featuring constant-pressure, proportional-pressure and constant-speed curves, each with three speed settings as well as an AUTOADAPT setting, removing the need to manually select the pump setpoint.

The new toolless, removable power connector results in fast and easy installation. Fewer callbacks can be expected due to its robust startup, self-venting ability and dry-running protection. The system air detection and venting mode can be activated through the Grundfos GO app. Grundfos GO also provides the ability to conveniently troubleshoot the system through the event log, run guided setup, set custom control modes and run firmware updates. Historical trend data for flow, head, estimated media temperature and on-cycle durations are available through the app.

A terminal box with conduit connections is provided for power connection.

3.2 Intended use

The pump is designed for circulating liquids in heating and air conditioning systems.

3.3 Pumped liquids

WARNING

Electric shock

Death or serious personal injury

- For indoor use only.
- This pump has not been investigated for use in swimming pool or marine areas.



WARNING

Fire or explosion hazard

Death or serious personal injury

- The pump must not be used for the transfer of flammable liquids such as diesel oil, gasoline and similar liquids.



The product is suitable for pumping clean, thin, non-aggressive and non-explosive liquids without solid particles or fibers or mineral oils. If required, 50 % of the volume solution of glycol and water can be used. However, a decrease in pump performance may occur due to an increase in the viscosity of the solution. Contact the manufacturer for information regarding suitability of the pump for pumping other liquids.

The pump is designed to circulate water from 36 to 230 °F (2 to 110 °C) up to a maximum pressure of 175 psi (12 bar), depending on the variant.

3.4 Identification

3.4.1 Nameplate

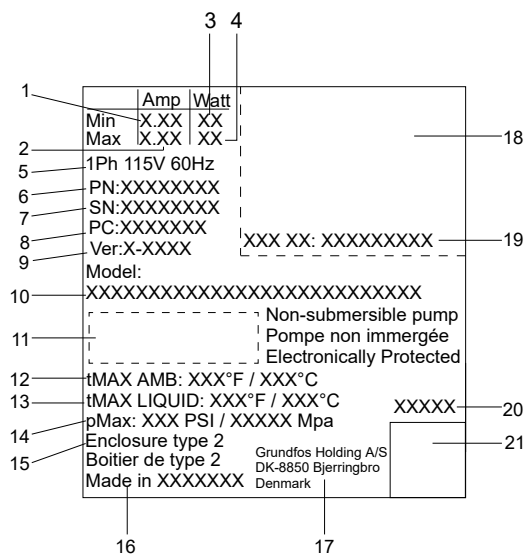

TM062374

Pos.	Description
1	Min. current consumption
2	Max. current consumption
3	Min. power consumption
4	Max. power consumption
5	Number of phases, voltage and frequency
6	Product number
7	Serial number
8	Factory code and production code (year and week)
9	Version letter and update number
10	Pump model
11	Enclosure class
12	Max. ambient temperature
13	Max. liquid temperature
14	Max. system pressure
15	Enclosure type
16	Country of origin
17	Grundfos address
18	Approvals
19	FCC radio approval ID
20	Combined legal product code
21	Data matrix

Related information

- [4.1 Inspecting the product](#)
- [7. Electrical connection](#)

3.4.2 Type key

Example: ALPHA 15-58 FR 115V 9H

Code	Explanation	Designation
ALPHA	Grundfos circulator	Pump type
15	Small circulators	
58	Maximum head [dm]	
F	Flange	Pipe connection
FR	Flange rotated	

3.5 Approvals



TM067110



TM073284



This equipment has been tested and found to comply with the limits for a class B digital device, pursuant to Part 15 of the FCC Rules.



Any changes or modifications to this equipment not expressly approved by the party responsible for compliance could void the user's authority to operate this equipment.

These limits are designed to provide reasonable protection against harmful interference in a residential installation. This equipment generates, uses and can radiate radio frequency energy and, if not installed and used in accordance with the instructions, may cause harmful interference to radio communications. However, there is no guarantee that interference will not occur in a particular installation. If this equipment does cause harmful interference to radio or television reception, which can be determined by turning the equipment off and on, the user is encouraged to try to correct the interference by one or more of the following measures:

- Reorient or relocate the receiving antenna.
- Increase the separation between the equipment and receiver.
- Connect the equipment to an outlet on a circuit different from that to which the receiver is connected.
- Consult the dealer or an experienced radio/TV technician for help.

4. Receiving the product

4.1 Inspecting the product



CAUTION

Crushing of feet

Minor or moderate personal injury

- Wear safety shoes when handling the product.



CAUTION

Sharp element

Minor or moderate personal injury

- Wear protective gloves.

1. Make sure that the delivered product corresponds to the order.
2. Make sure that the voltage and frequency of the product match the voltage and frequency of the installation site.

Related information

[3.4.1 Nameplate](#)

4.2 Scope of delivery

The box contains the following items:

- 1 pump
- 1 power connector
- 2 screws for the conduit box
- 1 check valve
- 1 blanking plug
- 2 gaskets
- 1 quick guide
- 1 safety instructions booklet.

5. Installation requirements

5.1 Radio frequency radiation exposure information (for Canada and US only) (only for ALPHA)

CAUTION

Radiation

Minor or moderate personal injury



- This equipment complies with FCC and ISED radiation exposure limits set forth for an uncontrolled environment. This equipment must be installed and operated with a minimum distance of 20 cm (0.66 ft) between the radiator and your body.

5.2 Optimal installation and operation

See below for information about the installation and setting of the product:

- Slow down the flow to dissipate the heat in the zones faster.
- A small temperature difference between the inlet and outlet of the boiler can cause inefficient boiler performance and in some cases short cycling. Lowering the flow of the circulator can prevent this from happening.
- By having a larger delta T going back to the boiler, the boiler eventually starts to condense. The efficiency of the boiler and system increases, thereby saving money and wear and tear on your system.
- In order to create a flow in a system, the pump needs to neutralize the system head loss before it can create a flow in the system.
- In case there is too little heat at the far end of the installation, choose a higher setting on the pump or check the hydronic balance of the system. An increase in the boiler supply temperature could also be a solution.
- When mounting the pump, ensure that the shaft is in a horizontal position to avoid air being trapped inside or bearings being worn out too quickly.
- Make sure that you have the proper voltage and that the wires are connected properly (black = phase, white = neutral, green or bare copper = ground).

Related information

[6.1 Mounting the product](#)

[7.1 Wiring the pump](#)

6. Mechanical installation

WARNING

Electric shock

Death or serious personal injury

- A damaged product must be repaired or replaced by Grundfos or a service workshop authorized by Grundfos.



CAUTION

Crushing of feet

Minor or moderate personal injury

- Wear safety shoes when opening the box and handling the product.



CAUTION

Sharp element

Minor or moderate personal injury

- Wear protective gloves.



The pump must always be installed with a horizontal motor shaft within $\pm 5^\circ$.



The pump is a non-submersible pump.



Due to interference of the touchscreen, keep a distance of minimum 5 mm from the front of the operating panel to all conductive materials, for example, metal cabinets and cables.

6.1 Mounting the product

The arrows on the pump housing indicate the flow direction through the pump. See the figure below.

Note that for certain housings, a check valve can be fitted in the outlet.

1. Fit the two gaskets supplied, if applicable, with the pump when you mount the pump in the pipe.



TM082452

2. Install the pump with a horizontal motor shaft within $\pm 5^\circ$.

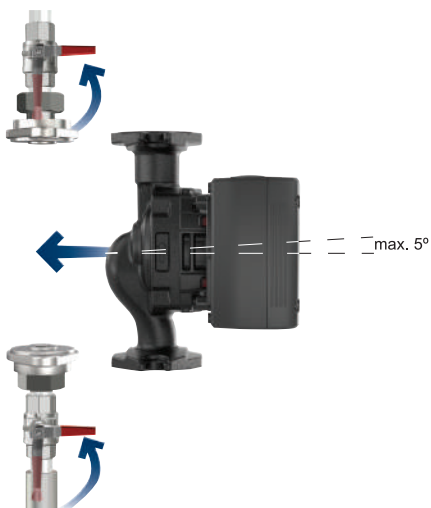

TM082453

3. Tighten the fittings or flange bolts. (what torque for flange and what for union)



TM082454

Related information

[5.2 Optimal installation and operation](#)

6.2 Changing the control box position

CAUTION



Hot surface

Minor or moderate personal injury

- Position the pump so that persons cannot accidentally come into contact with hot surfaces.

WARNING



Pressurized system

Minor or moderate personal injury

- Before dismantling the pump, drain the system or close the isolating valves on both sides of the pump. The pumped liquid may be scalding hot and under high pressure.



Make sure that the isolating valves are closed before rotating the control box. The pump must be pressureless before the control box is rotated. Drain the system or relieve the pressure inside the pump housing.

To change the position of the control box, do as follows:

1. Loosen and remove the four screws.

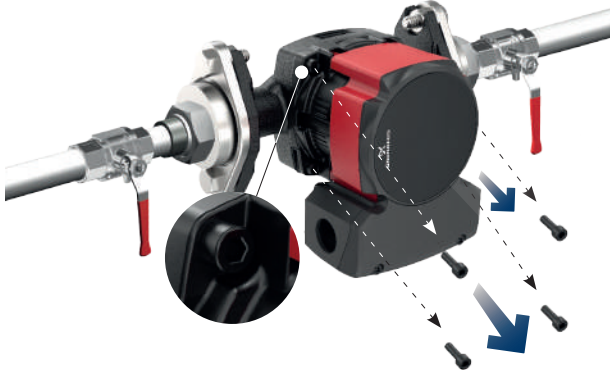

TM082508

3. Insert and cross-tighten the screws.



TM082510

2. Turn the pump head to the desired position.



TM082509

You can turn the control box in steps of 90° if the flanges are in standard position (F) and in steps of 180° if the flanges are in flange rotated position (FR).

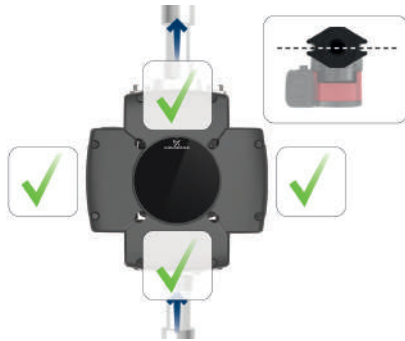

TM082458

Flanges in standard position (F)

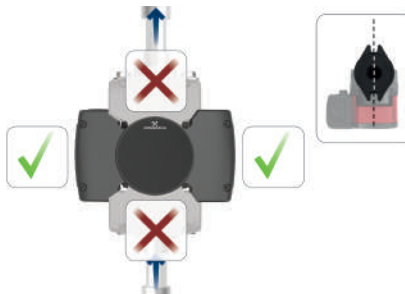

TM082457

Flanges in flange rotated position (FR)

7. Electrical connection

WARNING

Electric shock

Death or serious personal injury



- Switch off the power supply before you start any work on the product. Make sure that the power supply cannot be switched on accidentally.

WARNING

Electric shock

Death or serious personal injury



- Connect the product only to a properly grounded receptacle.

WARNING

Electric shock

Death or serious personal injury



- All electrical connections must be carried out by a qualified electrician in accordance with local regulations.

WARNING

Electric shock

Death or serious personal injury



- Use of the product on a circuit equipment with a GFCI can cause improper operation of the GFCI. Consult an electrician and observe all national, state and local electrical regulations, as applicable.

- The pump is electronically protected and therefore requires no external motor protection.
- Check that the supply voltage and frequency correspond to the values stated on the nameplate.
- Connect the pump to the power supply with the power connector supplied with the pump.

Related information

[3.4.1 Nameplate](#)

7.1 Wiring the pump

Note that the conduit connector and conduit are not supplied by Grundfos.

Follow the steps below to wire the pump:

1. Remove the lid from the conduit box, attach the conduit connector to the knockout opening and tighten the connector nut.



Use only a flexible conduit.

2. Take the power connector and lift the orange levers, and connect the black wire to L (phase), the white wire to N (neutral), and the green wire to  (ground).



The power connector can be fitted with AWG 20 - AWG 12 wires.

3. Press the orange levers down to tighten the wires.
4. Insert the power connector.
5. Mount the cover on the conduit box.

Related information

[5.2 Optimal installation and operation](#)

[11.1.1 Disconnecting the wires](#)

TM082786

8. Starting up the product

CAUTION

Radiation

Minor or moderate personal injury



- This equipment complies with FCC and ISED radiation exposure limits set forth for an uncontrolled environment. This equipment must be installed and operated with a minimum distance of 20 cm (0.66 ft) between the radiator and your body.

1. Fill the system with liquid and vent it.
2. Make sure the required minimum inlet pressure is available at the pump inlet.
3. Switch on the power supply.

The pump is factory set to constant curve (zone pump), AUTOADAPT.

You can change the settings on the operating panel or via Grundfos GO. We recommend to follow the guided setup in Grundfos GO.

Related information

- [8.1 Venting the pump](#)
- [10.2 Guided setup](#)

8.1 Venting the pump



TM083494

Venting the pump

Small air pockets trapped inside the pump may cause noise when starting up the pump. However, because the pump is self-venting through the system, the noise ceases over a period of time. Still, we recommend venting the pump in new installations or when the pipes have been emptied and refilled with water. You can vent the pump via Grundfos GO.

- If you follow the guided setup, you are asked if you want to vent the pump now.
- If you do not follow the guided setup, you can access the venting settings via the **Settings** menu.



The pump must not run dry.
You cannot vent the system through the pump.

Related information

- [8. Starting up the product](#)
- [10.2 Guided setup](#)
- [10.3 Air detection and system venting](#)

8.2 Dry-running protection

The dry-running protection protects the pump against dry running during startup and normal operation.

During startup

If water has not been detected, the pump rotates the impeller back and forward. If water is still not detected, it attempts again after 30 seconds.

The pump stops after maximum 30 attempts, and the spinner icon on the operating panel is spinning (temporary mode).

During normal operation

If dry running is detected during normal operation, the pump stops for 30 minutes and attempts again. After 144 attempts, the pump stops in alarm mode, Grundfos mini Eye flashes red and error code E4 is displayed.

The pump can be restarted by pressing anywhere on the operating panel (except the connect and lock icons). The pump will not detect dry running if dry running has been detected during the past 25 hours. If the pump has previously detected water, the pump can sustain 25 hours of dry-running operation.

Related information

- [9.2 Light fields indication](#)
- [12.8.8 Code 57 \(Dry running\)](#)

9. Control functions

9.1 Operating panel

LED symbols and buttons on the pump display

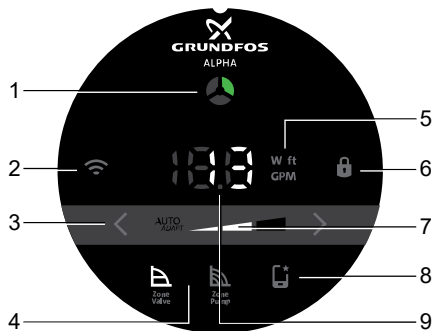

TM082425

Pos.	Description
1	Grundfos mini Eye The indicator light shows the operating status of the product.
2	Connect If lit, the pump is connected to Grundfos GO via Bluetooth.
3	Settings for control modes Use the arrows to toggle between I, II, III and AUTOADAPT.
4	Control mode You can select the control mode constant pressure (zone valve) or constant curve (zone pump).
5	Unit The indicator light shows the unit used for the number to the left. W = Watt, ft = feet and GPM = gallons per minute.
6	Lock This indicates that the operating panel is locked and no buttons can be used. It automatically locks after a few seconds. To unlock the panel, push and hold the icon for 1 second.
7	Settings for the selected control mode I, II, III or AUTOADAPT
8	Grundfos GO The pump has been set via Grundfos GO.
9	The light field indicates: <ul style="list-style-type: none"> Power consumption [W] Head [ft] Flow rate [gpm] Spinner Error code.

The operating panel has a touchscreen which means you can change settings by touching the icons on the operating panel.



Due to interference of the touchscreen, keep a distance of minimum 5 mm from the front of the operating panel to all conductive materials, for example, metal cabinets and cables.

Related information

[9.2 Light fields indication](#)

[9.3.1 Constant curve \(zone pump\)](#)

[9.3.2 Constant curve \(zone pump\), AUTOADAPT](#)

[9.3.3 Constant pressure \(zone valve\)](#)

[9.3.4 Constant pressure \(zone valve\), AUTOADAPT](#)

9.2 Light fields indication

The LEDs indicate the control mode, setting and operating status.

Factory setting

The pump is factory set to constant curve (zone pump), AUTOADAPT.

Active light fields	Description
	The control mode is set via Grundfos GO. When the pump is set via Grundfos GO, the icon is lit and the modes and settings on the operating panel are turned off.
	Constant pressure (zone valve)
	Constant curve (zone pump)
	Setting I
	Setting II
	Setting III
	The pump is running. ¹⁾
	Warning ¹⁾
	Alarm
	Spinner The pump is unavailable for changes to settings. The pump is still running. The spinner icon appears during software update and dry running.

¹⁾ The rotation of Grundfos mini Eye follows the direction of rotation of the impeller. The impeller in ALPHA rotates counterclockwise.

Related information

[8.2 Dry-running protection](#)

[9.1 Operating panel](#)

9.3 Control modes

ALPHA can be set to following control modes:

- Constant curve (zone pump)
- Constant pressure (zone valve)
- Proportional pressure (thermostatic radiator valve)
- Constant flow.

All control modes except constant flow can be set to pump setting I, II, III or AUTOADAPT.

All control modes can be set in Grundfos GO. Only constant-curve (zone pump) and constant-pressure (zone valve) control modes can be set on the operating panel.

9.3.1 Constant curve (zone pump)

In the constant-curve (zone pump) mode, the pump runs at a constant curve, which means that it runs at constant speed or power. The pump performance follows the selected constant curve. This control mode is especially suitable in applications where the characteristics of the heating system are steady, and the emitters require a constant flow. The selection of the constant-curve setting depends on the characteristics of the heating system and the actual required flow and heat demand.

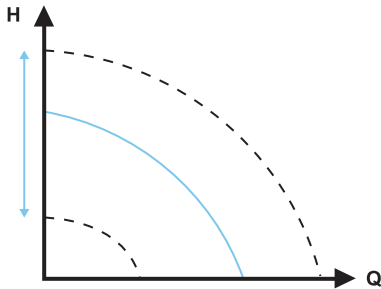

Constant curve

Related information

[9.1 Operating panel](#)

[10.8 Settings according to system type](#)

9.3.2 Constant curve (zone pump), AUTOADAPT

The constant curve (zone pump) AUTOADAPT setting ensures a balance between the minimum energy consumption of the pump and the maximum level of resident comfort.

This setting is designed for zone pump systems where the flow rate remains stable throughout the year compared to zone valve systems or systems with TRVs.

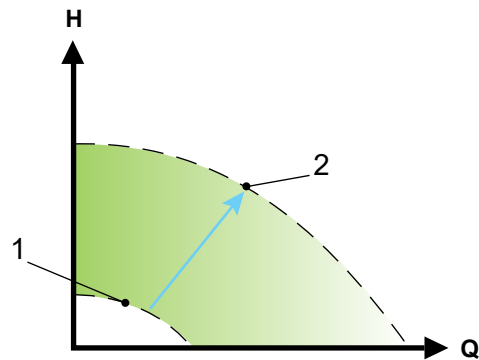

TM083658

Pos.	Description
1	Minimum curve
2	Maximum curve

When the pump is set to constant curve (zone pump), AUTOADAPT, the pump starts at a constant curve setting I every time the pump is turned on. If the zone or room thermostat has not turned the pump off after an extended operating period, the pump assumes there is not enough flow and ramps up the speed until it reaches the maximum performance curve. It maintains this setting until the pump is switched off by the room or zone thermostat. This is repeated every time the pump is turned on.

Related information

[9.1 Operating panel](#)

TM071005

9.3.3 Constant pressure (zone valve)

In the constant-pressure (zone valve) mode the pump runs at constant pressure which means the head (pressure difference) is kept constant, irrespective of the actual number of opened zones. The pump performance follows the selected constant-pressure curve. This control mode is especially suitable for underfloor heating and applications where the pump is used to supply a common header for multiple zone valves. The head across each zone will remain constant independent of how many zones request heat, thus a constant flow in each zone will be maintained, independent of other zones. The selection of the constant-pressure setting depends on the characteristics of the zones in the heating system and the actual heat demand.

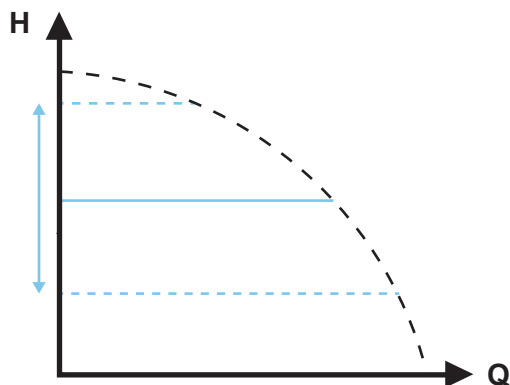

Constant pressure

Related information

[9.1 Operating panel](#)

[10.8 Settings according to system type](#)

TM063818

9.3.4 Constant pressure (zone valve), AUTOADAPT

With the constant pressure (zone valve) AUTOADAPT setting, the pump analyses the heating system and over time selects the best constant-pressure setpoint for the given operating conditions. It continuously optimizes the position of the constant-pressure curve via three steps:

1. The pump analyses the heat demand patterns of the heating system.
2. AUTOADAPT verifies whether the pump pressure is too high, too low or suitable.
3. The pump adjusts the setpoint and chooses the best suitable constant-pressure curve from the AUTOADAPT range. The pump will continue this cycle as long as it is running. See the figure below.

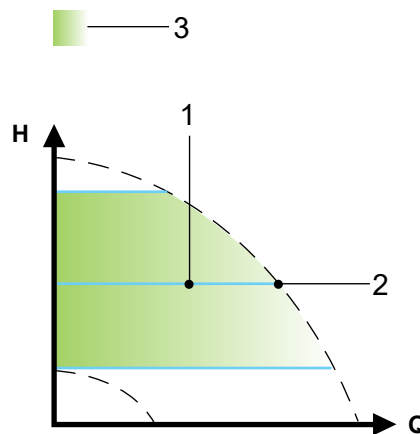

TM071002

Pos.	Description
1	Constant-pressure curve
2	Setpoint
3	AUTOADAPT performance range

If the power supply fails or is disconnected, the pump stores the AUTOADAPT setting in an internal memory and resumes the automatic adjustment when power supply has been restored.

Related information

[9.1 Operating panel](#)

9.3.5 Proportional pressure (thermostatic radiator valve (TRV))

In the proportional-pressure (thermostatic radiator valve (TRV)) mode, the pump runs at proportional pressure, which means the head (pressure) is reduced at falling heat demand and increased at rising heat demand. The pump performance follows the selected proportional-pressure curve. This control mode is especially suitable for applications where the heat emitters are equipped with a TRV which controls the flow depending on the room temperature. At increased flow, the losses in the distribution system (pipes and fittings) increase, hence the pumps increase the pressure to compensate and vice versa, hereby maintaining an almost constant differential pressure across the thermostatic radiator valve.

The proportional-pressure mode setpoint depends on the heating system's characteristics and the actual heat demand.

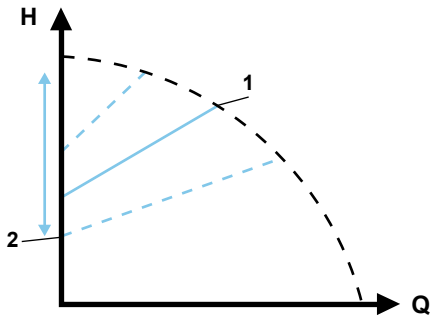

TM071003

Pos.	Description
1	H_{set}
2	$H_{set} \times 0.40$

Related information

[10.8 Settings according to system type](#)

9.3.6 Proportional pressure (thermostatic radiator valve (TRV)), AUTOADAPT

The thermostatic radiator valve (proportional pressure) AUTOADAPT setting analyses the heating system and over time selects the best proportional pressure setpoint under the given operating conditions. It continuously optimizes the position of the constant-pressure curve via three steps:

1. The pump analyses the heat demand patterns of the heating seating.
2. AUTOADAPT verifies whether the pump pressure is too high, too low or suitable.
3. The pump adjusts the setpoint and chooses the best suitable proportional-pressure curve from the AUTOADAPT range. The pump will continue this cycle as long as it is running. See the figure below.

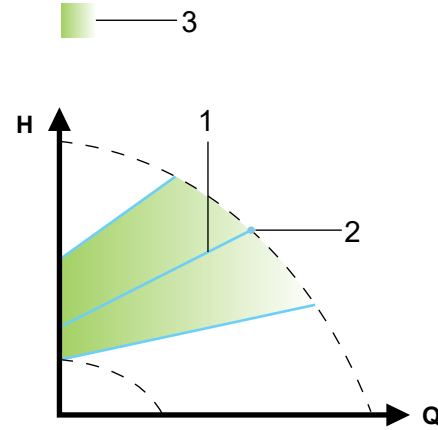

TM083657

Pos.	Description
1	Proportional-pressure curve
2	Setpoint
3	AUTOADAPT performance range

If the power supply fails or is disconnected, the pump stores the AUTOADAPT setting in an internal memory and resumes the automatic adjustment when power supply has been restored.

9.3.7 Constant flow

In this control mode, the pump maintains a constant flow in the system independently of the head.

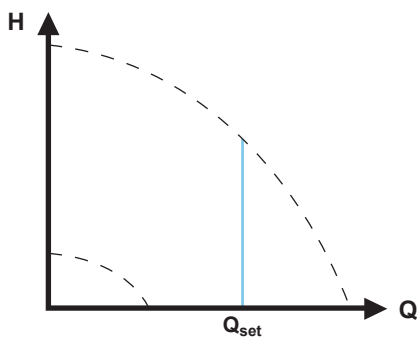

Constant-flow curve

We recommend that you select this control mode if you know the desired flow rate to the system.

This control mode is recommended for the following applications:

- Zone pump
- Boiler pump
- Tank pump.

Related information

- [TOPIC NOT IN MAP (empty topicContent)]
[href=concept-AAoqcwE.dita](concept-AAoqcwE.dita)
- [TOPIC NOT IN MAP (empty topicContent)]
[href=concept-AAoqcwE.dita](concept-AAoqcwE.dita)

10.8 Settings according to system type

10. Setting of the product

CAUTION

Radiation

Minor or moderate personal injury



- This equipment complies with FCC and ISED radiation exposure limits set forth for an uncontrolled environment. This equipment must be installed and operated with a minimum distance of 20 cm (0.66 ft) between the radiator and your body.

The operating panel can be used for the following:

- Connect to Grundfos GO.
- Lock and unlock the operating panel.
- Select constant pressure (zone valve) or constant curve (zone pump) control mode.
- Select pump setting (I, II, III or AUTOADAPT) for the two control modes available on the operating panel.
- Select to operate with Grundfos GO settings.

In Grundfos GO you can access all settings.

10.1 Connecting the product to Grundfos GO

Before connecting the product to Grundfos GO, the Grundfos GO app must be downloaded to your smartphone or tablet. The app is free of charge and available for iOS and Android devices.

The connection can be started either from the operating panel or Grundfos GO. If you have several products installed, we recommend starting the connection from the operating panel.

1. Open Grundfos GO on your device. Make sure that Bluetooth is enabled.
Your device must be within reach of the product to establish Bluetooth connection.
2. Go to the **Remote** menu in Grundfos GO.
3. Press the connect icon on the operating panel.
The connect icon flashes until your device is connected.
4. Press **CONNECT** in the top bar in Grundfos GO next to the message **ALPHA wants to connect**.
Once the connection is established, the LED is permanently on.
Grundfos GO is now loading the data for the product.

10.2 Guided setup

After the pump is connected to Grundfos GO, we recommend that you follow the guided setup in Grundfos GO.

The guided setup helps you to select the optimal settings for the current system. By choosing the optimal settings, you can lower the energy consumption and prevent potential noise problems.

If you select **Use default settings**, the pump uses the factory setting, constant curve (zone pump), AUTOADAPT.

Related information

- 8. [Starting up the product](#)
- 8.1 [Venting the pump](#)

TM071240

10.3 Air detection and system venting

ALPHA offers a **Continuous air detection and venting** feature which means the pump can detect air and push it quickly to the system vent.

If the pump detects air, it runs a venting sequence which enables more air to escape compared to letting the pump run at maximum speed during the entire process.

During system venting, the air is pushed to the system vent.

The function can be enabled in Grundfos GO in the **Settings** menu.

During the guided setup, you are asked if you want to vent the pump and system now. This is only a single event, and it will not enable this function.

Related information

8.1 Venting the pump

10.4 Flow limitation

You can set a minimum and maximum flow rate in Grundfos GO.

A minimum flow limit can be set to prevent the boiler from overheating. A maximum flow limit can be set to prevent noise in the system.

10.5 Trend data

In the **Trend data** menu in Grundfos GO, you can see system data for the last 10 or 100 on-cycles. An on-cycle is the period from when the pump turns on until it turns off. If the pump runs continuously for more than 24 hours, one on-cycle is registered and a new on-cycle will start even though the pump has not yet turned off. The 100 cycles view consists of 10 observations where each observation is the average of 10 on-cycles.

You can see the following data:

- **Duration of each on-cycle**
- **Flow**
- **Head**
- **Estimated media temperature.**

You can use the trend data for system optimization and fault finding.

10.6 Updating the firmware

1. Make sure your smart device has sufficient power.
2. Make sure your smart device is connected to the internet.
If there is no internet where the pump is installed, go to step 3 and then follow the instructions in Grundfos GO.
3. Connect your product to Grundfos GO if it is not already connected.
Once connected to Grundfos GO, the app automatically checks if the product has the latest firmware installed. If a newer version is available, a red dot in **Settings** menu will appear in Grundfos GO with the text **Firmware update available**.
4. Follow the guide in Grundfos GO to install the firmware update.

10.7 Resetting to factory settings

The product can be reset to factory settings in two ways:

- **Via Grundfos GO**
 1. Open Grundfos GO.
 2. Press the gear icon in the top right side of the screen.
 3. Go to the **Factory reset** menu and press **Reset**.
- **Via the operating panel**
 1. Press and hold the unit icon for 5 seconds.

10.8 Settings according to system type

System	Recommended control mode
--------	--------------------------

Zone pump system

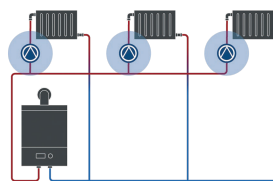

TM083013

Constant curve (zone pump)
Constant flow if you know the design flow of the system.

Zone valve system

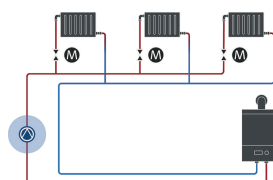

TM083012

Constant pressure (zone valve)

TRV system

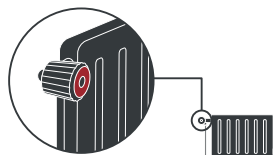

TM083015

Proportional pressure (TRV)

Underfloor heating with actuators

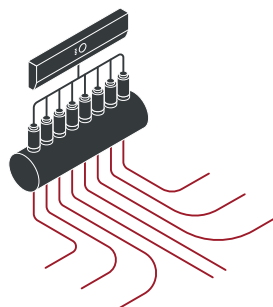

TM083014

Constant pressure (zone valve)

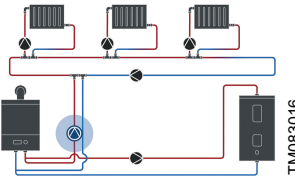
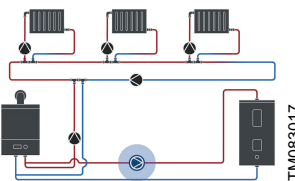
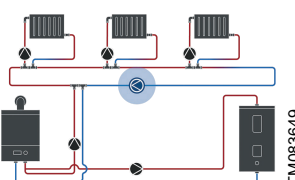
System	Recommended control mode
Boiler pump	
	<p>Constant curve (zone pump) Constant flow if you know the design flow of the system.</p>
Pump for indirect tank	
	<p>Constant curve (zone pump) Constant flow if you know the design flow of the system.</p>
Primary pump	
	<p>Constant curve (zone pump) Constant flow if you know the design flow of the system.</p>

Related information

[9.3.1 Constant curve \(zone pump\)](#)

[9.3.3 Constant pressure \(zone valve\)](#)

[9.3.5 Proportional pressure \(thermostatic radiator valve \(TRV\)\)](#)

[9.3.7 Constant flow](#)

11. Service

WARNING

Electric shock

Death or serious personal injury

- All electrical connections must be carried out by a qualified electrician in accordance with local regulations.



WARNING

Electric shock

Death or serious personal injury

- Switch off the power supply before you start any work on the product. Make sure that the power supply cannot be switched on accidentally.



WARNING

Electric shock

Death or serious personal injury

- A damaged product must be repaired or replaced by Grundfos or a service workshop authorized by Grundfos.



WARNING

Electric shock

Death or serious personal injury

- Connect the product only to a properly grounded receptacle.



WARNING

Pressurized system

Minor or moderate personal injury

- Before dismantling the pump, drain the system or close the isolating valves on both sides of the pump. Slowly loosen the screws and unpressurize the system. The pumped liquid may be scalding hot and under high pressure.



WARNING

Hot surface

Minor or moderate personal injury

- The pump housing may be hot due to the pumped liquid being scalding hot. Close the isolating valves on both sides of the pump and wait for the pump housing to cool down.



CAUTION

Sharp element

Minor or moderate personal injury

- Wear protective gloves.



CAUTION

Crushing of feet

Minor or moderate personal injury

- Wear safety shoes when moving the product.



CAUTION

Explosive environment

Minor or moderate personal injury

- Risk of explosion if the battery is replaced by an incorrect type.
- Dispose of used batteries according to the instructions.



CAUTION

Radiation

Minor or moderate personal injury

- This equipment complies with FCC and ISED radiation exposure limits set forth for an uncontrolled environment. This equipment must be installed and operated with a minimum distance of 20 cm (0.66 ft) between the radiator and your body.



11.1 Dismantling the product

Follow the steps below to dismantle the product:

1. Switch off the power supply.
2. Close the inlet and outlet valves.
3. Remove the lid from the conduit box, if applicable.
4. Pull out the power connector and disconnect the wires from the power connector.
5. Loosen and remove the conduit.
6. Loosen and remove the bolts from the pump flanges.
7. Remove the pump from the system.

Related information

[11.1.1 Disconnecting the wires](#)

11.1.1 Disconnecting the wires

Follow the steps below:

1. Switch off the power supply.
2. Remove the lid from the conduit box, if applicable.
3. Loosen the conduit.

4. Lift the orange levers to loosen the wires.
5. Pull the conduit out of the conduit box.

Related information

[7.1 Wiring the pump](#)

[11.1 Dismantling the product](#)

12. Fault finding

WARNING

Electric shock

Death or serious personal injury



- Switch off the power supply before you start any work on the product. Make sure that the power supply cannot be switched on accidentally.

WARNING

Electric shock

Death or serious personal injury



- A damaged product must be repaired or replaced by Grundfos or a service workshop authorized by Grundfos.

WARNING

Hot surface

Minor or moderate personal injury



- The pump housing may be hot due to the pumped liquid being scalding hot. Close the isolating valves on both sides of the pump and wait for the pump housing to cool down.

CAUTION

Pressurized system

Minor or moderate personal injury



- Before dismantling the pump, drain the system or close the isolating valves on both sides of the pump. The pumped liquid may be scalding hot and under high pressure.

CAUTION

Radiation

Minor or moderate personal injury





- This equipment complies with FCC and ISED radiation exposure limits set forth for an uncontrolled environment. This equipment must be installed and operated with a minimum distance of 20 cm (0.66 ft) between the radiator and your body.

12.1 Fault indication on the pump operating panel

Faults preventing the pump from operating properly are indicated on the operating panel with Grundfos mini Eye turning either yellow or red and the display showing an error code.





A warning is indicated when one indicator light in Grundfos mini Eye is turning yellow and rotating. The pump does not perform as expected, and action is required in case of underheating or discomfort.

An alarm is indicated when two indicator lights in Grundfos mini Eye are flashing red and the pump stops. Action is required.

Grundfos mini Eye	Description
	Warning indication
	Alarm indication

12.2 Overview of alarm and warning codes

Fault chart

Grundfos mini Eye	Code on operating panel	Code in Grundfos GO	Fault
	E1	51	Blocked motor
	E2	40	Undervoltage
	E3	29	Forced pumping
		4	Overvoltage
		72	Internal fault
		76	Internal fault
		85	Internal fault
	E4	57	Dry running
	E3	43	Impellers forced forward
	- 2)	35	Air in media

2) This error is not shown on the operating panel. It is logged and can be seen in Grundfos GO.

12.3 Resetting alarms and warnings manually with Grundfos GO

- Go to **Alarms and warnings**.
- Press **Reset alarm**.
All current alarms and warnings have been reset. However, if the fault causing the alarm or warning has not been removed, the alarm or warning will appear again.
- If you want to delete all alarms and warnings from the history log, press **Show log > Reset alarm and warning logs**.

12.4 Alarm and warning code logs

Grundfos GO will save up to 40 alarms and warnings in total in the **Alarms and warnings** menu.

12.5 Automatic deblocking

In case of a blocked rotor, the pump will start vibrating automatically with a frequency of around 3 Hz during startup. Any dirt deposits that might prevent the impeller from rotating will be broken up swiftly, and the pump will resume normal operation.

Related information

- [TOPIC NOT IN MAP (empty topicContent)]
[href=troubleshooting-apcQbZA.dita](troubleshooting-apcQbZA.dita)
- [TOPIC NOT IN MAP (empty topicContent)]
[href=troubleshooting-apcQbZA.dita](troubleshooting-apcQbZA.dita)
[12.8.1 Code 51 \(Blocked motor\)](#)

12.6 Overheated boiler

Cause	Remedy
The flow is too low.	<ul style="list-style-type: none"> Increase the flow.

12.7 Noise in the system

Cause	Remedy
The flow is too high.	<ul style="list-style-type: none"> Lower the flow.

12.8 Alarms

12.8.1 Code 51 (Blocked motor)

Grundfos mini Eye is flashing red, the displays show error code **E1** and the pump stops.

Cause	Remedy
The pump is blocked.	<p>Only a qualified specialist must perform such work.</p> <ol style="list-style-type: none"> Isolate the pump. Remove the pump head. Remove the deposits.

Related information

- [12.5 Automatic deblocking](#)

12.8.2 Code 40 (Undervoltage)

Grundfos mini Eye is flashing red, the displays show error code **E2** and the pump stops.

Cause	Remedy
The supply voltage to the pump is too low.	<ul style="list-style-type: none"> Make sure that the power supply is within the specified range.

12.8.3 Code 29 (Forced pumping)

Grundfos mini Eye is flashing red, the displays show error code **E3** and the pump stops.

Cause	Remedy
Other pumps or sources generate flow through the pump even if the pump is switched off.	<ul style="list-style-type: none"> Switch off the pump at the main switch. If the light in the pump display is on, the pump is running in forced pumping mode. Check the system for the correct position of the non-return valves. Check the system for defective non-return valves and replace the valves if necessary.

12.8.4 Code 74 (Overvoltage)

Grundfos mini Eye is flashing red, the displays show error code **E3** and the pump stops.

Cause	Remedy
The supply voltage to the pump is too high.	<ul style="list-style-type: none"> Make sure that the power supply is within the specified range.

12.8.5 Code 72 (Internal fault)

Grundfos mini Eye is flashing red, the displays show error code **E3** and the pump stops.

Cause	Remedy
Internal fault.	<ul style="list-style-type: none"> Replace the pump and dispose in an environmentally sound way according to local regulations, or contact Grundfos Service.

12.8.6 Code 76 (Internal fault)

Grundfos mini Eye is flashing red, the displays show error code **E3** and the pump stops.

Cause	Remedy
Internal fault.	<ul style="list-style-type: none"> Replace the pump and dispose in an environmentally sound way according to local regulations, or contact Grundfos Service.

12.8.7 Code 85 (Internal fault)

Grundfos mini Eye is flashing red, the displays show error code **E3** and the pump stops.

Cause	Remedy
Internal fault.	<ul style="list-style-type: none"> Replace the pump and dispose in an environmentally sound way according to local regulations, or contact Grundfos Service.

12.8.8 Code 57 (Dry running)

Grundfos mini Eye is flashing red, the displays show error code **E4** and the pump stops.

Cause	Remedy
Water is missing in the system or the system pressure is too low.	<ul style="list-style-type: none"> Fill the system with the correct amount of liquid. Prime and vent the pump before a new startup.

Related information

[8.2 Dry-running protection](#)

12.9 Warnings**12.9.1 Code 43 (Impellers forced forward)**

One indicator light in Grundfos mini Eye is yellow and rotating, the display shows error code **E3** and the pump is running.

Cause	Remedy
Other pumps or sources generate flow through the pump even if the pump is switched off.	<ul style="list-style-type: none"> Switch off the pump at the main switch. If the light in the pump display is on, the pump is running in forced pumping mode. Check the system for the correct position of the non-return valves. Check the system for defective non-return valves and replace the valves if necessary.

12.9.2 Code 35 (Air in media)

This is not shown on the operating panel. It is logged and can be seen in Grundfos GO.

Cause	Remedy
There is air in the pump and/or system.	<ul style="list-style-type: none"> Vent the pump and system. If the problem persists, investigate the system for leakages.

13. Technical data

Flow rate (Q)	Max. 13.6 gpm (3.1 m ³ /h)
Head (H)	Max. 19 ft (5.8 m)
Supply voltage	1 × 115 V, ± 10 %, 60 Hz
Motor protection	The pump requires no external motor protection.
Power usage (approximate)	Min.: 3 W Max.: 38 W
Enclosure class	Indoor use only. Enclosure type 2.
Insulation class	F
Ambient temperature	32-131 °F (0-55 °C)
Liquid temperature	36-230 °F (2-110 °C)
Relative humidity	Max. 95 %
Max. outlet pressure	175 psi (12 bars) (1.2 MPa)
Check valve	Use of a check valve reduces pump hydraulic performance.
Sound pressure level	< 25 dB(A)
Approvals	cULus and FCC. Complies to limits for class B digital device, pursuant to Part 15 of the FCC Rules.
Flange-to-flange length	6.5" (165 mm)
Pump housing	Electrocoated cast iron
Connection type	Flanged connection



The dew point of the air at ambient temperature must always be lower than the liquid temperature, otherwise condensation may form in the stator housing.

Inlet pressure

Liquid temperature [°F (°C)]	Minimum inlet pressure [psi (bar)]
167 (75)	0.75 (0.05)
203 (95)	7.25 (0.5)
230 (110)	15.7 (1.08)

14. Disposing of the product

This product or parts of it must be disposed of in an environmentally sound way.

1. Use the public or private waste collection service.
2. If this is not possible, contact the nearest Grundfos company or service workshop.

See also end-of-life information at www.grundfos.com/product-recycling.

15. Document quality feedback

To provide feedback about this document, scan the QR-code using your phone's camera or a QR code app.



[Click here to submit your feedback](#)

FEEDBACK_92795608

U.S.A.

Global Headquarters for WU
856 Kooamey Road
Brookshire, Texas 77423 USA
Phone: +1-630-236-5500

GRUNDFOS CBS Inc.
902 Kooamey Road
Brookshire, TX 77423 USA
Phone: 281-994-2700
Toll Free: 1-800-955-5847
Fax: 1-800-945-4777

GRUNDFOS Pumps Corporation
9300 Loiret Boulevard
Lenexa, Kansas 66219 USA
Tel.: +1 913 227 3400
Fax: +1 913 227 3500

Canada

GRUNDFOS Canada inc.
2941 Brighton Road
Oakville, Ontario
L6H 6C9
Tel.: +1-905 829 9533
Fax: +1-905 829 9512

Mexico

Bombas GRUNDFOS de México
S.A. de C.V.
Boulevard TLC No. 15
Parque industrial Stiva Aeropuerto
Apodaca, N.L. 66600
Tel.: +52-81-8144 4000
Fax: +52-81-8144 4010

Revision Info

Last revised on 04-2021

92795808 09.2023
ECM: 1375412