



# **Landscape Dripline Design**

**TORO**<sup>®</sup>

# Table of Contents

<b>Introduction</b> . . . . .	1
<b>Terminology</b> . . . . .	2-3
<b>General Design Parameters</b> . . . . .	4-8
Product Selection . . . . .	4
Water Availability and Quality . . . . .	4
Soil Types and Preparation . . . . .	5
Plant Material Classification and Planting Layouts . . . . .	5
Emitter and Dripline Selection . . . . .	6
Spacing Guidelines . . . . .	7
Dripline Placement From Edges . . . . .	7
Designing for Wind . . . . .	7
Designing for Slopes . . . . .	8
Designing for Elevation Differences . . . . .	8
<b>Typical Design Procedures</b> . . . . .	9-17
Designing a Subsurface System . . . . .	9
Design Worksheet . . . . .	10
Typical Design Steps . . . . .	10-17
<b>Irrigation Scheduling</b> . . . . .	18-19
Application Rate Formula . . . . .	18
Water Application Rate Table (In Inches Per Hour) . . . . .	18
Zone Run Time Scheduling Worksheet . . . . .	19
Installation Procedures . . . . .	20-34
Installation Guidelines . . . . .	20
Planting Guidelines . . . . .	21
Installation Steps . . . . .	22
Installation Details . . . . .	23-34
<b>Routine Preventative Maintenance</b> . . . . .	35-36
System Inspection . . . . .	35
Routine Inspection Checklist . . . . .	36
Component Maintenance Checklists . . . . .	36-38
Remote Control Valves . . . . .	36
Filters . . . . .	37
Pressure Regulators . . . . .	37
Dripline . . . . .	37
Flush Caps . . . . .	38
Troubleshooting Checklists . . . . .	39
Excessively Wet Soil Areas . . . . .	39
Excessively Dry Soils . . . . .	39
<b>System Components and Specifications</b> . . . . .	40-43
Drip Tubing . . . . .	40
Blank Tubing . . . . .	40
Filters . . . . .	40
Check Valve . . . . .	40
Flushing Cap . . . . .	41
Pressure Regulators . . . . .	41
Air Vent/Vacuum Relief Valve . . . . .	41
Compression Fittings and Adapters . . . . .	41
Coupling . . . . .	42
Micro Tubing . . . . .	42
Micro Fittings . . . . .	42
Micro Fitting Swivel Adapters . . . . .	42
Dual Goof Plug . . . . .	42
Micro Valve . . . . .	42
Optional Components . . . . .	43
Irrigation Controller . . . . .	43
Fertilizer Injector . . . . .	43
Water Meter . . . . .	43
Soil Moisture Sensor . . . . .	43

Toro provides more than just irrigation products — we provide turf solutions. For more than forty-five years, we've supplied a full line of quality irrigation equipment to fit any turf need. Customers have grown to trust Toro because we translate new technology into productive irrigation products for every turf requirement.

In addition to Drip In® PC Brown Dripline for at-grade installations, Toro also offers a complete below-grade dripline system, DL2000®, designed specifically for the residential and commercial turf markets. Toro DL2000® is the most technologically advanced subsurface irrigation system available. Through revolutionary ROOTGUARD® technology, DL2000 prevents emitter clogging while delivering optimal water application directly to the root zone. DL2000 is perfect for odd-shaped designs, median strips, public recreation areas and residential property — any place where sprinklers don't fit the application.

Whether installing dripline at-grade or below-grade, Toro has the perfect solution to fit your needs.

### Typical Dripline Layout

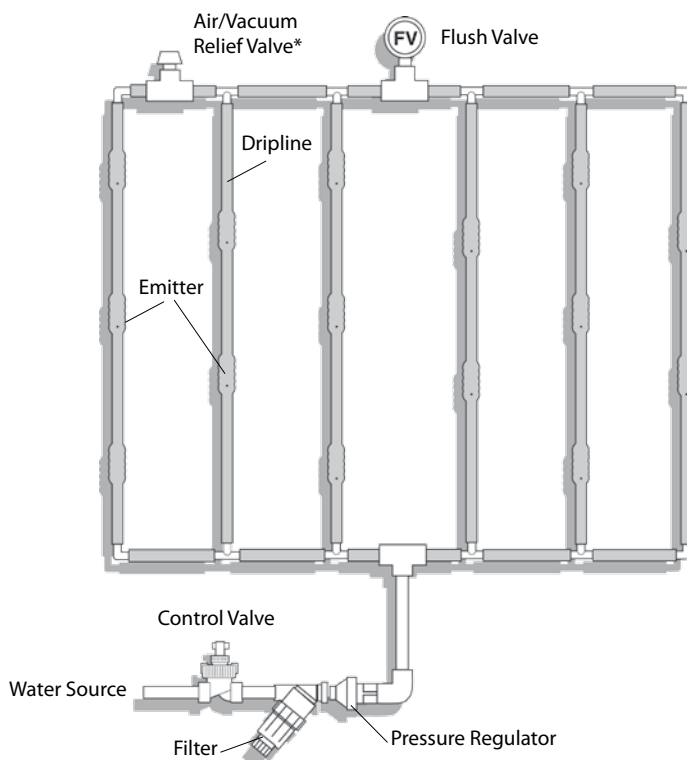

\*Only Required on Subsurface Installations



This manual has been written with the assumption that users already possess a fundamental understanding of basic irrigation design.

**Application Rate** — the rate at which a subsurface grid applies water to a specific zone, over a given period of time, measured in inches per hour.

**Backflow Prevention Device** — the device, required by law, on an irrigation system that prevents water from re-entering the potable water lines once it flows into the irrigation pipes.

**Blackwater** — wastewater from toilet, latrine, and aqua privy flushing and sinks used for food preparation or disposal of chemical or chemical-biological ingredients.

**BOD**— the abbreviation for “Biochemical Oxygen Demand;” a measure of the amount of oxygen required to neutralize organic wastes.

**Controller** — the device that sends timing commands to remote control valves for actuation.

**Design Operating Pressure** — the pressure a designer uses to determine spacing distances and flow for driplines. The design operating pressure is determined by subtracting estimated friction losses from the static water pressure.

**Dynamic Pressure** — the pressure reading in a pipeline system with water flowing.

**Effluent Water** — any substance, particularly a liquid, that enters the environment from a point source. Generally refers to wastewater from a sewage treatment or industrial plant.

**Emitter** — a device used to control the rate at which water is applied to a specific area. Emitters are usually injection molded out of chemical-resistant plastics and come in both inline and online configurations. Toro dripline is manufactured with factory-installed, inline emitters.

**Evapotranspiration** — the combined rate at which water evaporates into the atmosphere and/or is consumed by plants.

**Flow** — the movement of water through the irrigation piping system.

**Flush Cap** — a device used to automatically flush sediment and debris from driplines within a grid. Flushing occurs at the beginning of each irrigation cycle and ends as soon as the system operation pressure reaches 10 PSI.

**Flush Manifold** — the end line or pipe in a subsurface grid that connects to all the driplines. A flush valve and/or cap is installed in the manifold to flush debris and sediment from the grid during each irrigation cycle.

**FPS** — the abbreviation for “feet per second;” refers to the velocity of water in pipes.

**Friction Loss** — the loss of pressure (force) as water flows through the piping system.

**GPH** — the abbreviation for “gallons per hour;” unit of measure for water flow.

**GPM** — the abbreviation for “gallons per minute;” unit of measure for water flow.

**Greywater** —wastewater from washing machines, showers, bathtubs, lavatories and sinks that are not used for disposal of chemical or chemical-biological ingredients.

**I.D.** — the abbreviation for “inside diameter.”

**Lateral** — the pipe in an irrigation system located downstream from the remote control valve. Lateral pipes carry water directly to a zone.

**Main Line** — the pipe in an irrigation system that delivers water from the backflow prevention device to the remote control valves. This is usually the largest pipe on the irrigation system, generally under constant pressure and located upstream from the remote control valves.

NOTES:

**Manifold** — a group of control valves located together in the same area.

**O.D.** — the abbreviation for “outside diameter.”

**PSI** — the abbreviation for “pounds per square inch;” unit of measure for water pressure.

**PVC Pipe** — Poly Vinyl Chloride pipe; the most common pipe used in irrigation systems.

**P.O.C.** — abbreviation for “point of connection.” This is the location on the irrigation system where a tap is made for connection of a backflow prevention device or water meter.

**Potable Water** — water used for drinking purposes.

**Reclaimed Water** — domestic wastewater that has been treated to a quality suitable for a beneficial use and is under the direct control of a treatment plant.

**Remote Control Valve** — the component in the irrigation system that regulates the on/off of water from the main line to the driplines; activated by the controller.

**Service Line** — the pipe supplying water from the city water main to the water meter.

**Spacing** — the distance between the emitters or the driplines.

**Static Water Pressure** — the pressure that exists in a piping system when there is no flow; measured in pounds per square inch (PSI).

**Subsurface Grid** — a group of parallel, inline driplines that are connected to supply manifolds and flush manifolds.

**Supply Manifold** — the pipe connected to the remote control valves that supplies water to the driplines within a subsurface grid.

**Surge** — the build-up of water pressure in a piping system due to certain characteristics of the pipe, valves and flow.

**TDS** — the abbreviation for “total dissolved solids.” The sum of all inorganic and organic particulate material within a given amount of water. TDS is an indicator test used for wastewater analysis and is also a measure of the mineral content of bottled water and groundwater.

**TSS** — the abbreviation for “total suspended solids.” The sum of all non-dissolved inorganic and organic material within a given amount of water. The other component of Total Solids (TS) in water are Total Dissolved Solids, so generally  $TSS + TDS = TS$ .

**Velocity** — the speed at which water flows through the piping system; measured in feet per second (FPS).

**Wastewater** — water containing waste including grey water, black water or water contaminated by waste contact, including process-generated and contaminated rainfall runoff.

**Water Main** — the city water pipe located in the street or right-of-way.

**Water Pressure** — the force of water that exists in a piping system; measured in pounds per square inch (PSI).

**Working Pressure** — the remaining pressure in the irrigation system when all friction losses are subtracted from the static pressure.

**Zone** — a subsurface grid or area of dripline that is controlled by the same remote control valve.

### **Design Parameters**

Toro dripline is designed for use in applications using the grid concept, with supply and flush manifolds at each end to create a closed-loop system. The result of the grid design is a completely subsurface-wetted area that is ideal for plant growth and root development. Toro dripline can also be installed on both sides of tree and shrub rows when the grid installation is not justified.

### **Product Selection**

Pressure-compensating dripline is available in two nominal emitter flow rates, 0.5 GPH and 1.0 GPH with emitters spaced at 12" and 18" intervals. Please consult performance charts for actual flows. Product choice is dependent on site conditions and soil types. The choice of dripper spacing, dripline lateral spacing and depth is dependent on the types of soil and plants used.

### **Water Availability and Quality**

The allowable water flow (75% of available flow) and pressure are the determining factors for the maximum allowable zone flow. This is determined by the capacity at the point of connection and supply restrictions beyond the point of connection. Available flow and pressure can be obtained from the following sources:

- Physical pressure and volume tests (most reliable)
- Your local water district office
- Engineered calculations based on the size of the point of connection, meter and static pressure

Always make these determinations during the time of day at which the water pressure is at its lowest point.

Water quality determines the type of filter used, any necessary treatment and, in the case of reclaimed or effluent water, which drip emitter product to use. Water quality varies significantly according to the source which can be classified generally as:

- Potable water
- Irrigation district water
- Greywater or industrial recycled water
- Effluent water
- Recycled water
- Well water

NOTES:

Potable water, the most common type of water used in landscape applications, has relatively little debris and chemical contamination. Therefore, it only needs to be filtered with a screen or disk filter. With other water sources, it is advisable to obtain a water analysis prior to designing and installing the system. Some of the important parameters are:

- Total dissolved solids (tds)
- Iron content
- Calcium, magnesium, sulfates, bicarbonates and hardness
- Chemical compounds present, bod and tss (grey water, industrial treated water and recycled water)
- The types and amount of sediment present (irrigation district water and well water)

### **Soil Types and Preparation**

For design purposes, soil classifications of clay (heavy), loam (medium) and sand (light) are used in conjunction with plant types to determine the emitter and lateral spacings necessary to provide a uniform subsurface soil moisture regime for the plant material.

As with all types of landscape irrigation systems, properly prepared soil is necessary to provide a homogenous bed for proper plant establishment, plant growth and uniform water distribution. Heavily compacted and layered soils should be ripped and tilled at a uniform eight- to twelve-inch depth to improve the consistency and tilth of the soil.

Soil and water analyses are recommended when the soil texture, soil Ph and water quality are in doubt. This is necessary in order to recommend soil amendments and water treatment when required. If possible, pre-irrigate the installation site when the soil is too dry to till and trench.

### **Plant Material Classification and Planting Layouts**

Emitter and lateral spacings are determined by soil and plant material classifications. For design purposes, two general plant classifications are used: 1) trees, shrubs and ground cover, and 2) turf. Turf plantings have a much more intense and compact root structure, thus requiring a closer emitter and lateral spacing to efficiently irrigate these areas.

Planting layouts determine the size and type of irrigation design necessary to provide uniform moisture distribution. Individual or isolated planting areas separated by large expanses of unplanted areas or hardscapes require individual grids that provide moisture within the foliage canopy of the landscaped area.

NOTES:

Narrow, linear tree and shrub plantings require narrow, linear sub-surface grids consisting of two to four laterals. More intense plantings that provide a complete foliage canopy at maturity require a grid design that applies uniform moisture levels within the foliage canopy (turf, groundcover, and dense shrub and tree plantings). Use the Spacing Guidelines Table (Table 1.2) to determine the proper emitter and lateral spacing.

**Emitter and Dripline Selection**

Toro offers the following types of dripline products:

Dripline	Tubing Dia.	Flow Rate	Pressure Comp.	Emitter Spacing	ROOTGUARD® Protected	Installation Type	
						Below-Grade	At-Grade/Mulched Over
DL2000®	5/8"	0.5 & 1.0 GPH	Yes	12", 18"	Yes	X	X
Drip In®	5/8"	0.5 & 1.0 GPH	Yes	12", 18"	No		X
Microline	1/4"	0.5 GPH	No	6", 12"	Yes	X	X
Soakerline™	1/4"	0.5 GPH	No	6", 12"	No		X

TABLE 1.1



NOTES:

**Using 1/4" dripline**

Toro's two 1/4" dripline offerings, Microline and Soakerline, are ideal for small, tight areas because of their flexibility. They can also be used to loop around trees and bushes. They're often used to retrofit sprinkler risers and bubblers to subsurface drip because they easily attach to a multi-outlet manifold.

**Spacing Guidelines**

Soil Type	Emitter Spacing	Row Spacing	Emitter Flow	Burial Depth*
<b>Medium Sand</b> • Trees/Shrubs/Groundcover • Turf*	12" 12"	18" 12"	1.0 GPH 1.0 GPH	4" 4"
<b>Loam</b> • Trees/Shrubs/Groundcover • Turf*	18" 12"	18" 18"	1.0 GPH 1.0 GPH	6" 4"
<b>Clay</b> • Trees/Shrubs/Groundcover • Turf*	18" 18"	24" 18"	0.5 GPH 0.5 GPH	6" 4"

\* For Subsurface Only

TABLE 1.2

**Dripline Placement From Edges**

Consideration of dripline location is necessary when laying out zone edges. Hardscape materials act as heat collectors and cause landscape edges to dry out before the center of the landscape, making it essential to compensate by placing the first driplines no more than two to four inches from the landscape edge. In uncontained landscape areas, start the first dripline two to four inches outside of the planted area. In subsurface applications specifically watering turf, add dripline over the supply and flush manifolds to ensure that these edges have adequate moisture coverage.

**Wind**

As with all total-coverage irrigation systems, attention must be given to windward turf edges in high-wind areas to prevent browning. Place the first dripline no more than two to four inches from the edge of hardscaped areas or two to four inches outside the turf edge in uncontained landscape areas. Add an extra dripline six inches from the first line between the first and second lateral lines on the windward lateral edge.

NOTES:

**Slopes**

Driplines should be located parallel to the contour of slopes whenever possible. Since dripline runoff occurs on areas with a slope of greater than 3%, consideration must be given to dripline density from the top to the bottom of the slope. The dripline on the top two-thirds of the slope should be placed at the recommended spacings for the soil type and plant material in use. On the lower one-third, the driplines should be spaced 25% wider. The last dripline can be eliminated on slopes exceeding 5%. For areas exceeding ten feet in elevation change, zone the lower one-third of the slope separately from the upper two-thirds to help control drainage.

**Elevation Differences**

When utilizing non-pressure-compensating dripline, elevation differences of five feet or more require separate zones or individual pressure regulators for each six-foot difference on uniform slopes (see detail number 17, p. 31).

When working with rolling landscapes with elevation differences of five feet or more within a zone, it is best to use pressure-compensating dripline to equalize pressure differentials created by the elevation differences.

Though vacuum relief valves aren't necessary when installing Toro dripline at-grade - even when mulching over - all subsurface irrigation zones must have a vacuum relief valve at the highest point in order to eliminate the vacuum created by low-line drainage, which causes soil ingestion. This is especially crucial when the dripline laterals are placed perpendicular to the contour of the slope as in street medians. All subsurface dripline laterals within the elevated area must be connected with an air relief lateral (see detail number 12, p. 28).

In-line spring-check or swing-check valves should be used on slopes where low-line drainage could cause wet areas in the lowest areas of an irrigation zone (see detail number 23, p. 34).

### Designing a System

Try designing your own dripline system using the diagram shown below and the tables and information provided in the remainder of this section. When you have finished the design worksheet, check your answers on page 17 at the end of this section.

Design a typical dripline installation for zone #1 where the width is 5' and the length is 50'.

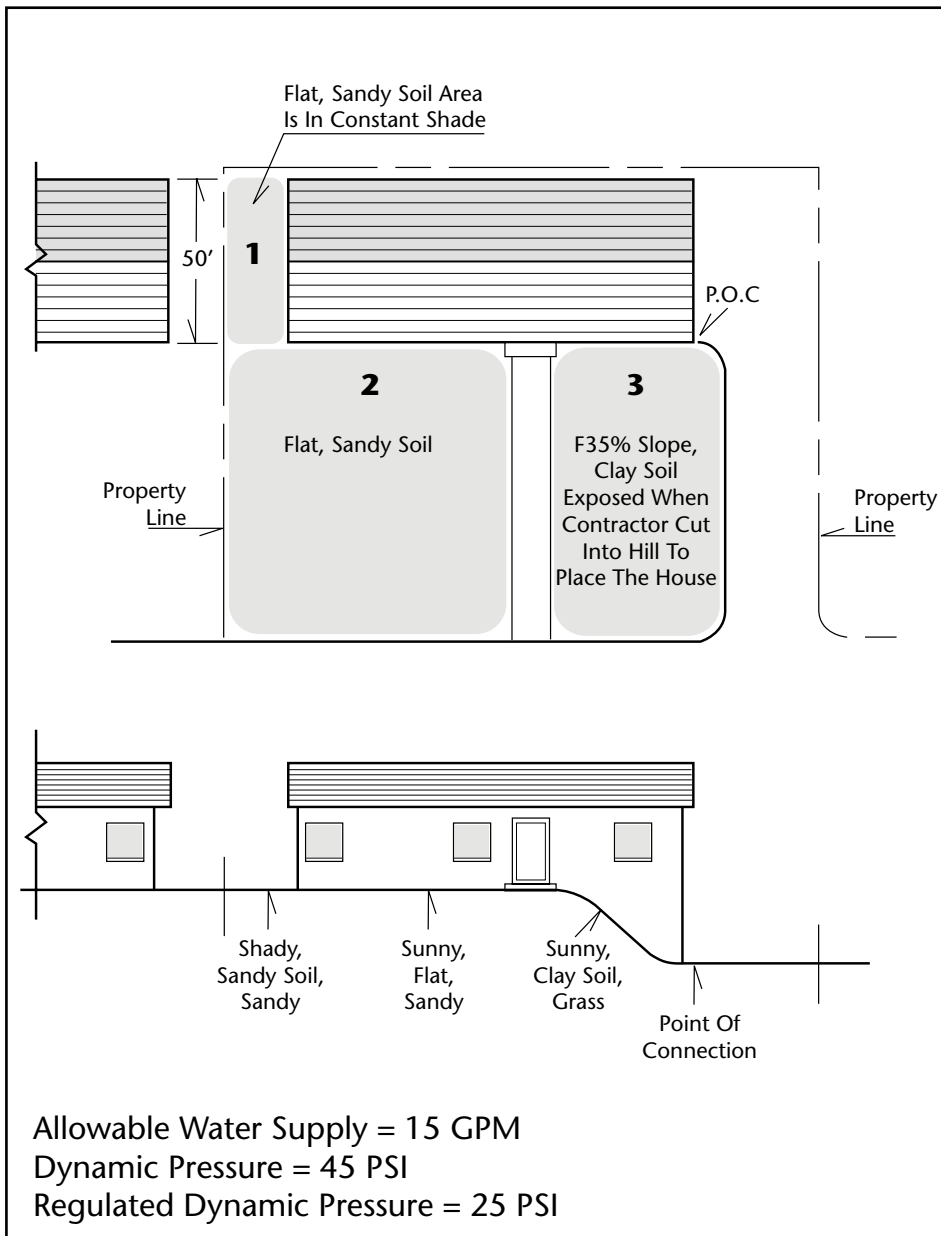

Fig. 1

NOTES:

**Design Worksheet**

Use this worksheet to determine the type and quantity of product required for the system.

DW1 Allowable Water Supply \_\_\_\_\_ GPM

DW2 Dynamic Pressure \_\_\_\_\_ PSI

	Zones*					
	1	2	3	4	5	6
DW3 Soil Texture						
DW4 Plant Type						
DW5 Slope %						
DW6 Dripline Product						
DW7 Emitter Spacing						
DW8 Max. Dripline Lateral Spacing						
DW9 Nominal Flow Rate						
DW10 Actual Flow Rate						
DW11 Max. Run Length						
DW12 Exact Lateral Spacing						
DW13 Zone Flow (GPM)						

\* The number of zones may vary depending on the specific needs of each installation.

TABLE 2.1

**Typical Design Steps**

**Step 1:** Obtain or draw a scaled plan of the area to be irrigated.

**Step 2:** Locate the point of connection on the scaled plan.

- Determine the water meter size and/or allowable volume of the water source: \_\_\_\_\_ GPM (DW1)
- Verify the regulated dynamic water pressure: \_\_\_\_\_ PSI (DW2)

At this point in a typical installation, it would be necessary to select a pressure regulating device to establish/control the pressure in the system. Since there's a number of factors that can apply to a design (slope, length of run, dripline type — pressure-compensating vs. non-pressure-compensating), a regulated dynamic pressure of 25 PSI has been chosen for this example.

Step 3: Note the site and environmental parameters.

- Soil texture (clay, loam or sand): \_\_\_\_\_ (DW3)
- Plant material(s) (trees, shrubs, ground cover or turf):  
 \_\_\_\_\_ (DW4)
- Direction and degree of slope: \_\_\_\_\_% (DW5)

NOTES:

**Step 4:** Lay out the laterals.

- Use Table 2.2 below to determine the type of dripline product necessary to fit the irrigation needs of the site (i.e., pressure-compensating or non-pressure-compensating; microline or dripline).

Dripline product: \_\_\_\_\_ (DW6)

Dripline	Tubing Dia.	Flow Rate	Pressure Comp.	Emitter Spacing	ROOTGUARD® Protected	Installation Type	
						Below-Grade	At-Grade/Mulched Over
DL2000®	5/8"	0.5 & 1.0 GPH	Yes	12", 18"	Yes	X	X
Drip In®	5/8"	0.5 & 1.0 GPH	Yes	12", 18"	No		X
Microline	1/4"	0.5 GPH	No	6", 12"	Yes	X	X
Soakerline™	1/4"	0.5 GPH	No	6", 12"	No		X

TABLE 2.2



Use non-pressure-compensating dripline in applications with less than 20 PSI pressure in flat areas.

- Using the Spacing Guidelines Table below, determine the maximum recommended spacing between drippers and spacing between driplines based on plant material and soil types.

Soil Type	Emitter Spacing	Row Spacing	Emitter Flow	Burial Depth*
<b>Medium Sand</b>				
• Trees/Shrubs/Groundcover	12"	18"	1.0 GPH	4"
• Turf*	12"	12"	1.0 GPH	4"
<b>Loam</b>				
• Trees/Shrubs/Groundcover	18"	18"	1.0 GPH	6"
• Turf*	12"	18"	1.0 GPH	4"
<b>Clay</b>				
• Trees/Shrubs/Groundcover	18"	24"	0.5 GPH	6"
• Turf*	18"	18"	0.5 GPH	4"

\* For Subsurface Only

TABLE 2.3

Emitter spacing: \_\_\_\_\_ inches (DW7)

Maximum dripline lateral spacing: \_\_\_\_\_ inches (DW8)

NOTES:

**Step 4:** Lay out the laterals: (cont.)

- Using the Spacing Guidelines Table, determine the nominal emitter flow rate.

Nominal emitter flow rate: \_\_\_\_\_ GPH (DW9)\*



\* Actual flow is a function of pressure. Use the Flow vs. Pressure Table (Table 2.4) to determine actual flow per emitter: \_\_\_\_\_ GPH (DW10)

EMITTER FLOW (IN GPH) VS. PRESSURE								
	Tube Dia.	Nominal Flow	Actual Flow					
			15 PSI	20 PSI	25 PSI	30 PSI	35 PSI	40 PSI
DL2000® and Drip In®	5/8"	0.5 GPH	0.53	0.53	0.53	0.53	0.53	0.53
	5/8"	1.0 GPH	1.02	1.02	1.02	1.02	1.02	1.02
Microline and Soakerline™	1/4"	0.5 GPH	0.50	0.60	0.70	n/a	n/a	n/a

TABLE 2.4

- Determine the maximum recommended run length from Table 2.5 below for the selected product and pressure.

Maximum length of run: \_\_\_\_\_ feet (DW11)

MAXIMUM RECOMMENDED LENGTH OF RUN @ 0% SLOPE						
	Tube Dia.	Nominal Flow	Initial Pressure	Spacing Between Emitters		
				6"	12"	18"
DL2000® and Drip In®	5/8"	0.5 GPH	15 PSI	n/a	250'	350'
	5/8"	1.0 GPH	15 PSI	n/a	160'	240'
	5/8"	0.5 GPH	25 PSI	n/a	360'	515'
	5/8"	1.0 GPH	25 PSI	n/a	240'	340'
	5/8"	0.5 GPH	35 PSI	n/a	400'	565'
	5/8"	1.0 GPH	35 PSI	n/a	260'	375'
	5/8"	0.5 GPH	40 PSI	n/a	460'	650'
	5/8"	1.0 GPH	40 PSI	n/a	300'	430'
Microline and Soakerline™	1/4"	0.5 GPH	20 PSI	19'	33'	n/a

TABLE 2.5

NOTES:

**Step 4:** Lay out the laterals: (cont.)

- Calculate the exact lateral spacing based on the dimensions of the area to be irrigated with subsurface drip.

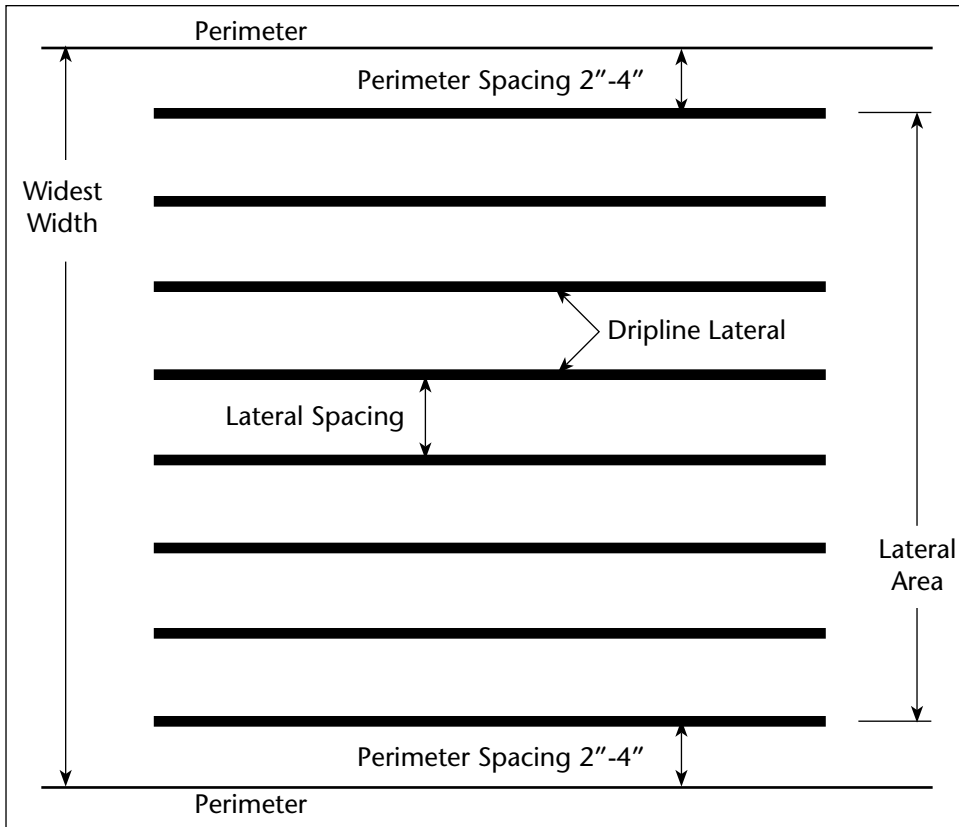

TABLE 2.6

- A. Measure, in inches, the subsurface drip area at its widest width.  
 Width: \_\_\_\_\_ inches
  
- B. The first and last lateral perimeter spacings can be no further than two to four inches from the confining hardscape or two to four inches outside of unconfined landscapes. For this example we will use 4" spacing.
  
- C. Subtract the sum of the perimeter spacings from the width to determine the lateral area to be covered by subsurface driplines.

Width (in inches) – perimeter spacings (in inches)  
 = Lateral area: \_\_\_\_\_ inches

NOTES:

■ **Step 4:** Lay out the laterals: (cont.)

D. Divide the lateral area (as determined in Step C above) by the recommended lateral spacing (DW8) to obtain the total number of spaces between laterals. Round off to the nearest whole number to determine the exact number of spaces necessary to cover the drip area.

$$\frac{\text{Lateral area}}{\text{Dripline lateral spacing}} = \text{_____ spaces between driplines}$$

E. Add 1 to the number of spaces between driplines (from Step D above) to determine the total number of driplines across the widest part of the zone.

$$1 + \text{Number of spaces between driplines} = \text{Total lengths of dripline: _____}$$

■ **Step 5:** For applications exceeding a 3% slope, place the laterals parallel to the slope contour. Increase the calculated lateral spacing by 25% on the lower one-third of the slope to avoid excessive drainage.

For areas exceeding 10 feet in elevation change, zone the lower one-third of the slope separately from the upper two-thirds to help control drainage.

■ **Step 6:** Determine the total estimated dripline footage required for each zone. There will always be some waste with each installation. Therefore, you should plan for additional footage by applying an appropriate factor for each dripline footage calculation (10%-25% should suffice).

A. Total dripline footage required: \_\_\_\_\_ = length of runs x number of laterals

B. Total dripline footage required x 1.10 (10%) = \_\_\_\_\_ total estimated dripline footage required

(round off to nearest whole number)



NOTES:

- **Step 7:** Calculate the total estimated gallons per minute (GPM) per zone by using one of the two following methods. Be sure to use the total estimated dripline per zone (see Step 6-A above).

Zone flow: \_\_\_\_\_ GPM (DW13)

- Determine the total number of drip emitters in each zone, then calculate the flow per zone based on the total flow rate of all drippers.

Step A:

$$\text{Number of drippers} = \frac{\text{Dripline footage required (6A above)} \times 12''}{\text{Dripline emitter spacing (inches)}} \text{ (within the zone)}$$

Step B:

$$\text{Total number of drippers} = \frac{\text{Flow per zone in GPM} \times \text{dripper flow rate (GPH)}}{60 \text{ (minutes)}}$$

OR

- Calculate zone flow by multiplying the total footage of dripline in hundreds (footage/100) by the flow per 100 feet obtained from the following table.

FLOW RATE PER 100 LINEAR FEET (@ 20 PSI)				
Product	Nominal Flow	Emitter Spacing	Actual Flow/100 ft.	
			GPH	GPM
DL2000® and Drip In®	0.5 GPH	12"	53.00	0.88
	0.5 GPH	18"	35.33	0.59
	1.0 GPH	12"	102.00	1.70
	1.0 GPH	18"	67.99	1.13
Microline and Soakerline™	0.5 GPH	6"	124.00	2.06
	0.5 GPH	12"	62.00	1.03

TABLE 2.7

NOTES:

- **Step 8:** Locate and size both the supply and flush manifolds in each zone. Both manifolds should be sized to accommodate the entire flow of the zone in GPM. (For details, refer to the Toro Technical Data Book, Form No. 490-1737).
- **Step 9:** Determine the number and location of the flush caps for each zone at a minimum of 10 PSI. One flush cap is required for each 15 gallons per minute of zone flow. Place the flush caps at the hydraulic center of the flush manifold(s) (see details 15 and 16, p. 30).
- **Step 10:** (Subsurface installations only) Calculate the total number of air/vacuum relief valves from the following table.

1/2" AIR VACUUM RELIEF VALVE (Item No. T-YD-500-34)			
Dripline	Nominal Flow	12" Emitter Spacing	18" Emitter Spacing
DL2000	0.5 GPH	750'	1,125'
DL2000	1.0 GPH	390'	585'

TABLE 2.8



One air vacuum relief valve is required per footage length indicated in the chart above. For example, two air vacuum relief valves are needed for 1,500' of dripline with 0.5 GPH flow and 12" emitter spacing.

Place air vacuum relief valve(s) at the highest point(s) of each zone. Using an air vacuum relief lateral, connect the air vacuum relief valve to all dripline laterals within the elevated area (see details 15 and 16, p. 30). If the supply and flush manifolds are at the same depth as the dripline, and are at the highest point in the zone, they can be used as the air relief lateral.

NOTES:

■ **Step 11:** Size pressure regulators based on the total zone flow using the table below.

PRESSURE REGULATORS				
Product	Flow Range (GPM)	Pre-Set Operating Pressure (PSI)	Inlet Size (NPT)	Outlet Size (NPT)
T-PMR-15 LF	1/10 - 8 GPM	15 PSI	3/4" FNPT	3/4" FNPT
T-PMR-25 LF	1/10 - 8 GPM	25 PSI	3/4" FNPT	3/4" FNPT
T-PMR-25 MF	2 - 20 GPM	25 PSI	3/4" FNPT	3/4" FNPT
T-PMR-25 HF	10 - 32 GPM	25 PSI	1" FNPT	1" FNPT
T-PMR-40 MF	2 - 20 GPM	40 PSI	3/4" FNPT	3/4" FNPT

TABLE 2.9

■ **Step 12:** Size the zone filter according to the total zone flow (see DW13) using the Filter Sizing Table below. To eliminate the chance of debris contamination in the event of a main or sub-main break, use one filter per zone close to the dripline

FILTERS					
Item Number	Size (MIPT)	Flow (GPM)	Maximum Pressure	Element Type	Mesh Size
T-ALFS7150-L	3/4"	25 GPM	142 PSI	Stainless Screen	150
T-ALFS10150-L	1"	35 GPM	142 PSI	Stainless Screen	150

TABLE 2.10

**ANSWERS FOR ZONE 1, TABLE 2.1, PAGE 10**

DW1: 15 GPM	DW8: 12"
DW2: 25 PSI	DW9: 1.0
DW3: SAND	DW10: 1.02
DW4: GRASS	DW11: 234'
DW5: 0%	DW12: 13"
DW6: PC	DW13: 4.25 GPM
DW7: 12"	

# Irrigation Scheduling

Irrigation scheduling with dripline uses the same methods of calculation as with sprinklers. The dripline grid system is designed to wet the irrigated area completely by methods similar to those used with sprinklers, supplying water in inches per hour. For efficient water application, it is necessary to apply water rates equal to or less than the rate at which the plants use water (evapotranspiration rate; ET). The ET rate is expressed in inches per unit of time, thus our application rates are expressed in inches per hour. *(For regional ET data, refer to the Toro Rainfall and Evapotranspiration Data Book, Form No. 490-1358.)*

The following formula is used to determine application rates for subsurface drip irrigation.

$$\frac{\text{Application rate (inches per hour)} = 231.1 \times \text{Emitter flow (GPH)}}{\text{Dripper spacing} \times \text{Dripline spacing (in inches)}}$$

For example: Dripline row spacing = 12"  
 Dripline emitter spacing = 12"  
 Emitter flow rate = .53 GPH  
 $231.1 \times .53 \text{ GPH} = .85 \text{ inches per hour}$   
 $12 \text{ (inches)} \times 12 \text{ (inches)}$

Or, use the Water Application Rate Table below to determine application rates.

	Emitter Spacing	Flow Rate	Dripline Spacing		
			12"	18"	24"
DL2000® and Drip In®	12"	0.5 GPH	0.85	0.57	0.43
	18"	0.5 GPH	0.57	0.38	0.28
	12"	1.0 GPH	1.64	1.09	0.82
	18"	1.0 GPH	1.09	0.73	0.55
	Emitter Spacing	Flow Rate	Dripline Spacing		
			6"	12"	18"
Microline and Soakerline™	6"	0.5 GPH	3.98	1.99	1.33
	12"	0.5 GPH	1.99	1.00	0.66

TABLE 3.1

NOTES:

**Zone Run Time Scheduling Worksheet**

To determine zone run times, obtain the following information:

- monthly evapotranspiration value for the location
- irrigation application rate

*(For regional ET data, refer to the Toro Rainfall and Evapotranspiration Data Book, Form No. 490-1358.)*

The following formulae can be used to determine run times.

$$\text{Run time per week} = \frac{\text{Weekly evapotranspiration rate}}{\text{Application rate}}$$

$$\text{Run time per day} = \frac{\text{Run time per week}}{\text{Days per week}}$$

MONTH:						
ZONES						
DAY	1	2	3	4	5	6
Sun.						
Mon.						
Tues.						
Wed.						
Thurs.						
Fri.						
Sat.						

\* The number of zones may vary depending on the specific needs of each installation.

TABLE 3.2

# Installation Procedures

## Special Considerations for Subsurface Installations

1. The typical recommended pipe depth for dripline is 4" below finished grade.
2. For turf areas where aerification is part of normal maintenance operations, tubing must be buried below the reach of aerification equipment.
3. Use 710 Series compression fittings for all dripline connections to ensure the integrity of the connection. Use ¼-inch barbed fittings for microline connections.
4. It is imperative that DL2000 dripline is installed at a uniform depth and width according to specifications.

Dripline can be installed using one of the following methods:

INSERTION METHOD	ADVANTAGES	DISADVANTAGES
Hand trenching or backfilling	<ul style="list-style-type: none"> <li>- Handles severe slopes and confined areas</li> <li>- Uniform depth</li> </ul>	<ul style="list-style-type: none"> <li>- Slow</li> <li>- Labor intensive</li> <li>- Disrupts existing turf and ground</li> </ul>
Oscillating or vibrating plow (cable or pipe pulling type)	<ul style="list-style-type: none"> <li>- Fast in small-to-medium installations</li> <li>- Minimal ground disturbance</li> <li>- No need to backfill the trench</li> </ul>	<ul style="list-style-type: none"> <li>- Depth must be monitored closely</li> <li>- Cannot use on steeper slopes (20%)</li> <li>- Requires practice to set and operate adequately</li> <li>- Tends to "stretch" pipe</li> </ul>
Trenching machine	<ul style="list-style-type: none"> <li>- Faster than hand trenching</li> <li>- May use 1" blade for most installations</li> <li>- Uniform depth</li> </ul>	<ul style="list-style-type: none"> <li>- Slower, requires labor</li> <li>- Disrupts surface of existing turf</li> <li>- Backfill required</li> </ul>
Tractor-mounted 3-point hitch insertion implement	<ul style="list-style-type: none"> <li>- Fastest method, up to four plow attachments with reels</li> <li>- Packer roller compacts soil over pipe</li> </ul>	<ul style="list-style-type: none"> <li>- Only suitable for areas large enough to maneuver a small tractor</li> </ul>

5. When possible, pressure test the system before covering trenches or, when plowing, pre-test for leaks prior to planting.

## **Planting Guidelines**

1. Pre-irrigate to ensure that the soil is hydrated to field capacity before planting begins. This is especially important when planting sod or hydroseeding.
  
2. When planting container plants with pot sizes wider than the dripline lateral spacing, there are two options:
  - Plant the oversized plants prior to installing the dripline laterals and plant the smaller plants after installing the dripline laterals.
  
  - OR
  
  - Plant all plants after installing the dripline, taking care to pre-cut and tape the open ends of the dripline when planting the oversized plants. Re-connect the severed dripline after planting.
  
3. As with all types of irrigation, it is critical that the root balls are not allowed to dry out during the plant-establishment period. Initial postplanting irrigation is critical, so it is necessary to over-irrigate to ensure water transfer between the landscape soil medium and container plant root balls.
  
4. When planting sod or hydroseeded grasses, establishment can be accomplished without supplemental overhead watering by:
  - making sure the soil is hydrated to field capacity prior to planting.
  
  - thoroughly rolling the sod to ensure optimum contact between the sod and the soil medium. Use multiple-start run times (up to 10 times per day) until the sod has knit into the soil. Take care not to let the sod dry out during this period.
  
  - using multiple start times as described above to establish seeded or hydroseeded grasses.

NOTES:

**Installation Steps**

- Assemble and install filter, remote control valve and pressure-regulating valve assembly(ies) according to detail numbers 1 and 2, p. 23.
- Assemble and install supply header(s) according to detail numbers 3, 5, 4 and 6, p. 24-25. Tape or plug all open connections to prevent debris contamination.
- Assemble and install exhaust header(s) in accordance with detail numbers 7 and 8, p. 26. Tape or plug all open connections to prevent debris contamination.
- Install dripline laterals. Tape or plug all open ends while installing the dripline to prevent debris contamination.
- Install air vacuum relief valve(s) at the highest point(s) of the zone(s) according to detail numbers 9, 10, 11 and 12, p. 27-28. (only required on subsurface installations)
- Thoroughly flush supply header(s) and connect dripline laterals while flushing.
- Thoroughly flush dripline laterals and connect to exhaust header(s) or interconnecting laterals while flushing.
- Thoroughly flush exhaust header(s) and install line flushing valves according to detail number 13, p. 29.



Thorough flushing of each installation segment is necessary to ensure that no debris contamination occurs.



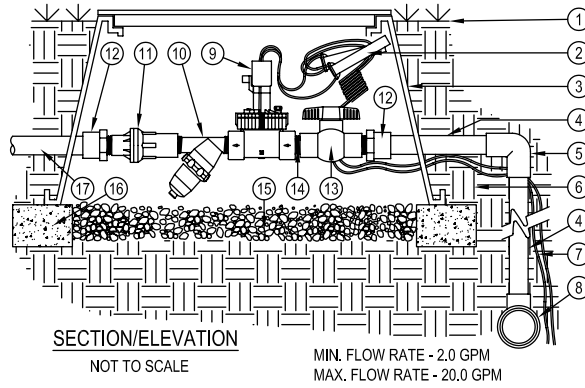

Detail No.1  
 DZK-EZF-075-LF

- |   |   |
|---|---|
| 1. FINISH GRADE.  | 9. TORO EZF-26-04 INLINE VALVE.(*)              |
| 2. CONTROL WIRES WITH 36" SERVICE COIL AND WATERPROOF WIRE CONNECTIONS, DBY OR EQUAL.     | 10. TORO 150 MESH Y-FILTER.(*)                  |
| 3. RECTANGULAR PLASTIC VALVE BOX. HEAT BRAND STATION NUMBER ON LID IN 2" HIGH CHARACTERS. | 11. TORO 25 PSI LOW-FLOW PRESSURE REGULATOR.(*) |
| 4. PVC MAINLINE PER SPECIFICATIONS (LENGTH AS REQUIRED).                                  | 12. SCH 40 PVC MALE ADAPTER.                    |
| 5. SCH 40 PVC ELBOW (SxS).  | 13. SCH 40 PVC BALL VALVE.(*)                   |
| 6. NATIVE SOIL PER SPECIFICATIONS.  | 14. SCH 80 PVC CLOSE NIPPLE.(*)                 |
| 7. CONTROL WIRES TO CONTROLLER.   | 15. PEA GRAVEL SUMP, MINIMUM 6" DEEP.           |
| 8. PVC MAINLINE FITTING.  | 16. BRICK SUPPORTS (4 COMMON BRICKS REQUIRED).  |
|   | 17. LATERAL LINE TO DRIP SYSTEM.                |
- \*PARTS IN DRIP ZONE KIT

Installation

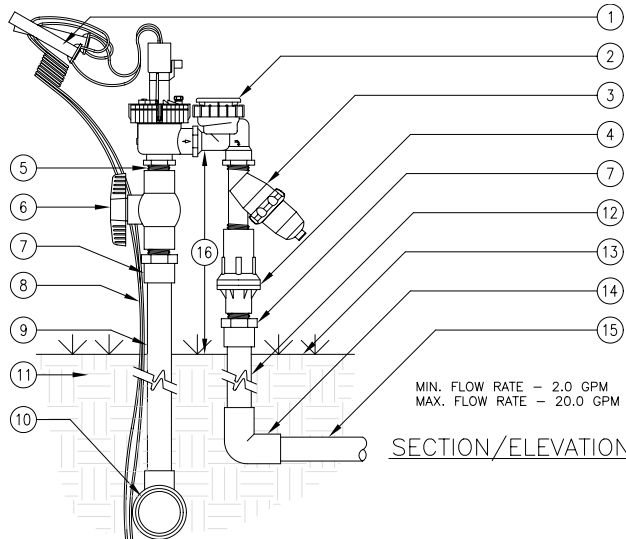

Detail No.2  
 DZK-EZF-075-MF

- |  |  |
|--|--|
| 1. CONTROL WIRES WITH 12" SERVICE COIL AND WATER PROOF WIRE CONNECTIONS, DBY OR EQUAL. | 9. PVC MAINLINE PER SPECIFICATIONS.                  |
| 2. TORO EZF-29-03 ANTI-SIPHON VALVE (*).   | 10. PVC MAINLINE FITTING.                            |
| 3. TORO 150 MESH Y-FILTER (*).   | 11. NATIVE SOIL PER SPECIFICATIONS.                  |
| 4. TORO 25 PSI MEDIUM FLOW PRESSURE REGULATOR (*).                                     | 12. PVC LATERAL LINE PER SPECIFICATIONS.             |
| 5. SCH 80 PVC CLOSE NIPPLE (*).  | 13. FINISH GRADE.                                    |
| 6. SCH 40 PVC BALL VALVE (*).  | 14. PVC SCH 40 ELBOW (SxS).                          |
| 7. SCH 40 PVC MALE ADAPTER.  | 15. LATERAL LINE TO DRIP SYSTEM.                     |
| 8. CONTROL WIRES TO CONTROLLER.  | 16. HEIGHT ABOVE GRADE PER LOCAL CODES (8" MINIMUM). |
- (\* ) PARTS IN DRIP ZONE KIT.

■ Recommended Installation Instructions

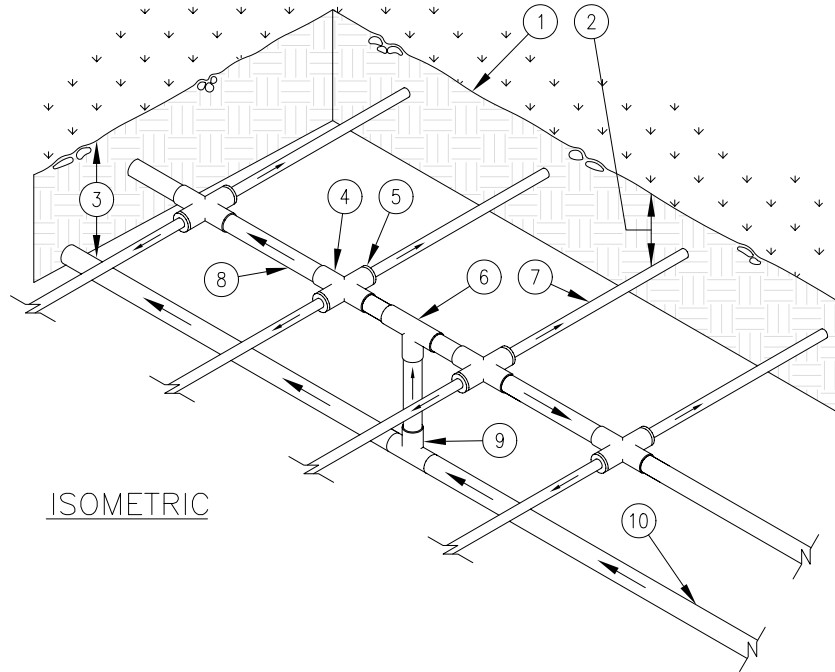

Detail No.3  
Center-Feed  
Sub-Manifold

- |   |   |
|---|---|
| 1. FINISH GRADE.                                    | 6. PVC TEE (SxSxS).                         |
| 2. DEPTH OF TUBING PER SPECIFICATIONS.              | 7. DRIPLINE LATERAL.                        |
| 3. DEPTH OF PVC SUPPLY MANIFOLD PER SPECIFICATIONS. | 8. PVC SUB-MANIFOLD.                        |
| 4. PVC CROSS (SxSxSxS).                             | 9. PVC TEE (SxSxS).                         |
| 5. TORO COMPRESSION ADAPTER (T-CA-710).             | 10. PVC SUPPLY MANIFOLD FROM DRIP ZONE KIT. |

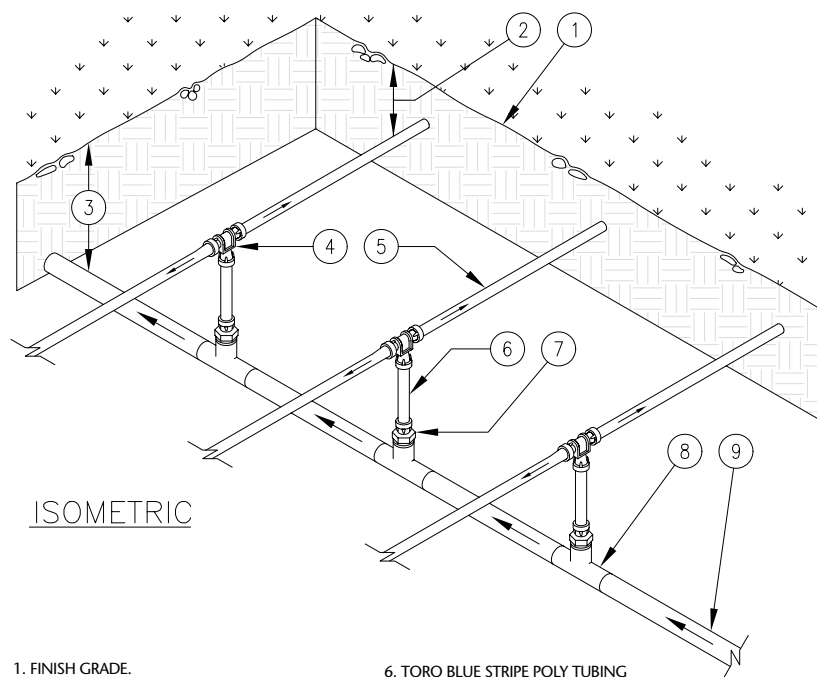

Detail No.4  
Center-Feed  
Supply-Manifold

- |   |  |
|---|--|
| 1. FINISH GRADE.                                    | 6. TORO BLUE STRIPE POLY TUBING (T-EHD1645-XXX) LENGTH AS NECESSARY. |
| 2. DEPTH OF TUBING PER SPECIFICATIONS.              | 7. TORO LOC-EZE X 1/2\"/>  |
| 3. DEPTH OF PVC SUPPLY MANIFOLD PER SPECIFICATIONS. | 8. PVC TEE (SxSxS).  |
| 4. TORO LOC-EZE TEE (T-FTT16).                      | 9. PVC SUPPLY MANIFOLD FROM DRIP ZONE KIT.                           |
| 5. DRIPLINE LATERAL.                                |  |

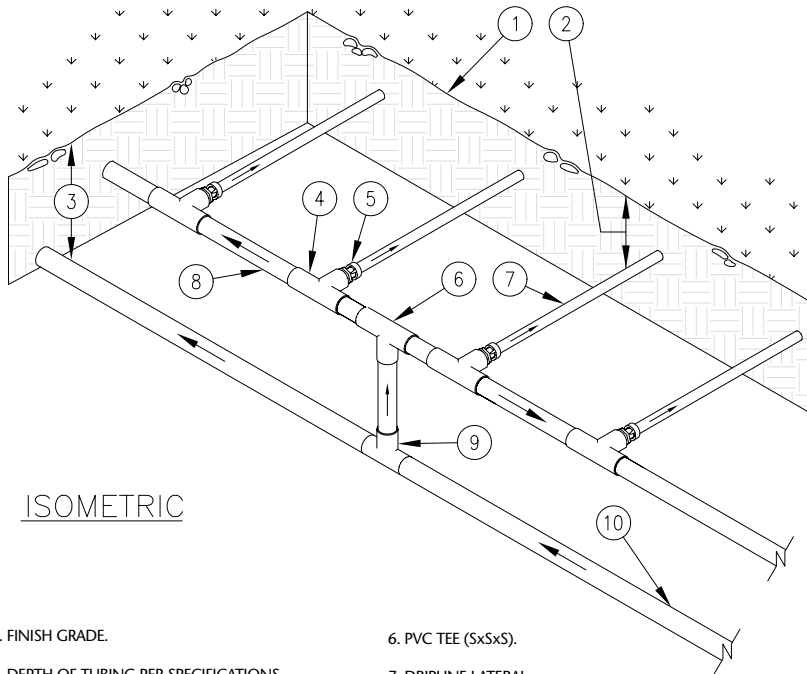

ISOMETRIC

- |   |   |
|---|---|
| 1. FINISH GRADE.                                    | 6. PVC TEE (SxSxS).                         |
| 2. DEPTH OF TUBING PER SPECIFICATIONS.              | 7. DRIPLINE LATERAL.                        |
| 3. DEPTH OF PVC SUPPLY MANIFOLD PER SPECIFICATIONS. | 8. PVC SUB-MANIFOLD.                        |
| 4. PVC TEE (SxSxT).                                 | 9. PVC TEE (SxSxS).                         |
| 5. TORO LOC-EZE X 1/2" MPT ADAPTER (T-FAM16).       | 10. PVC SUPPLY MANIFOLD FROM DRIP ZONE KIT. |

**Detail No.5**  
**End-Feed Supply**  
**Sub-Manifold**

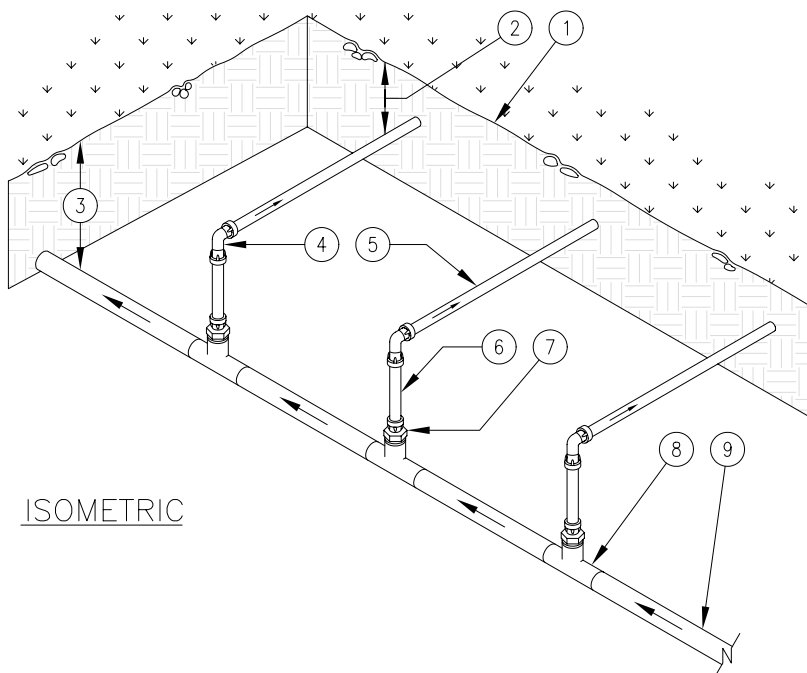

ISOMETRIC

- |   |  |
|---|--|
| 1. FINISH GRADE.                                    | 6. TORO BLUE STRIPE POLY TUBING (T-EHD1645-XXX) LENGTH AS NECESSARY. |
| 2. DEPTH OF TUBING PER SPECIFICATIONS.              | 7. TORO LOC-EZE X 1/2" MTP ADAPTER (T-FAM16).                        |
| 3. DEPTH OF PVC SUPPLY MANIFOLD PER SPECIFICATIONS. | 8. PVC TEE (SxSxT) WITH 1/2" FPT OUTLET.                             |
| 4. TORO LOC-EZE ELBOW (T-FEE16).                    | 9. PVC SUPPLY MANIFOLD FROM DRIP ZONE KIT.                           |
| 5. DRIPLINE LATERAL.                                |  |

**Detail No.6**  
**End-Feed**  
**Supply-Manifold**

■ Recommended Installation Instructions

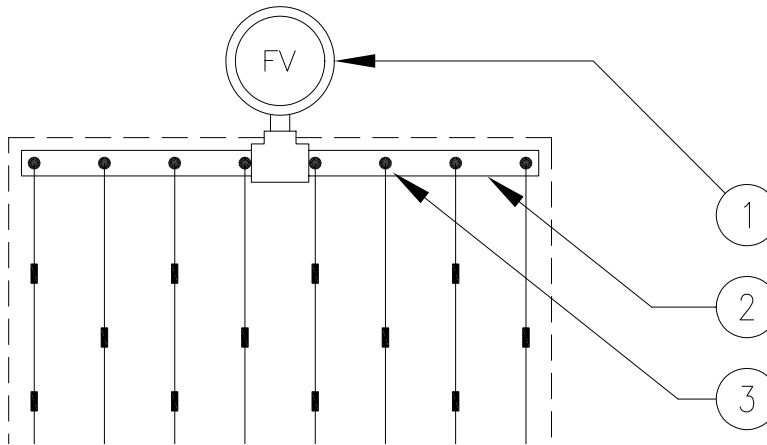

Detail No.7  
Center-Feed  
Layout

1. TORO AUTOMATIC FLUSH VALVE (T-FCH-H-FIPT) PLUMBED TO FLUSH MANIFOLD AT LOW POINT.
2. PVC FLUSH MANIFOLD.
3. TORO MANIFOLD-TO-ELBOW CONNECTION (TYP).

HIGH POINT ON SLOPE

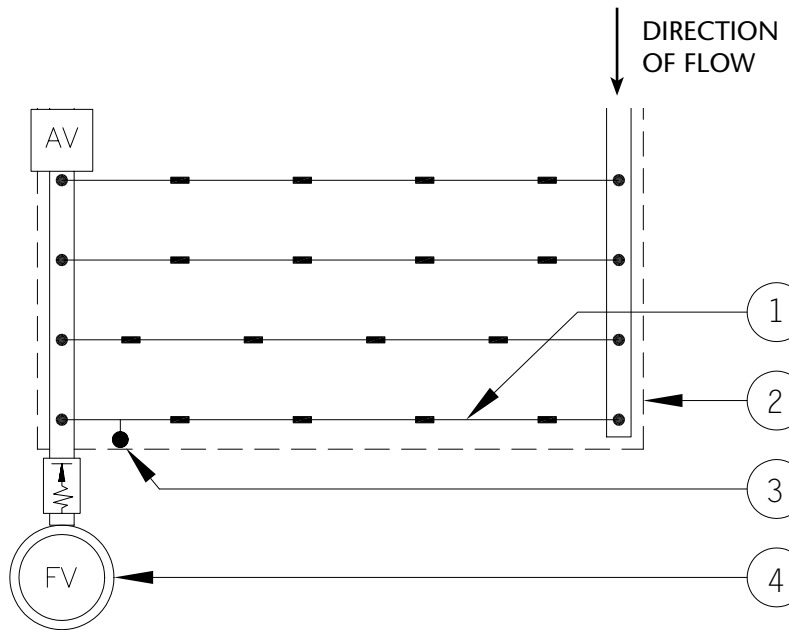

Detail No.8  
End-Feed  
Layout

1. DRIPLINE LATERAL.
2. AREA PERIMETER.
3. DL2000 OPERATION INDICATOR (T-DL-MP9), OPTIONAL.\*
4. TORO AUTOMATIC FLUSH VALVE (T-FCH-H-FIPT) PLUMBED TO FLUSH MANIFOLD AT LOW POINT.

\*SUBSURFACE INSTALLATIONS ONLY

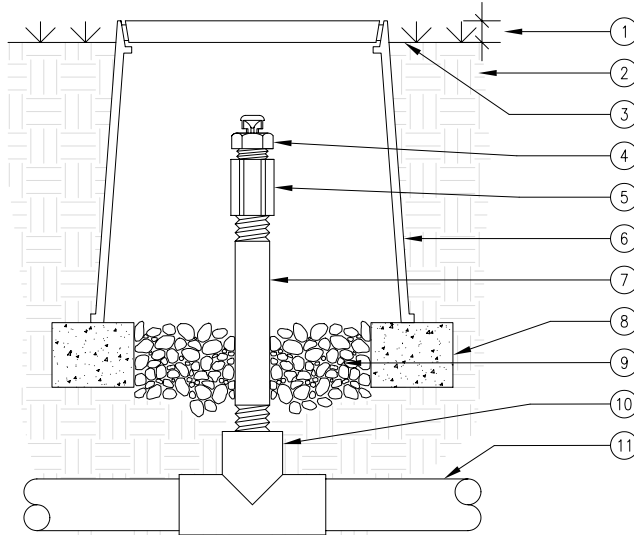

SECTION/ELEVATION

- |   |  |
|---|--|
| <ul style="list-style-type: none"> <li>1. 1" ABOVE FINISH GRADE.</li> <li>2. NATIVE SOIL PER SPECIFICATIONS.</li> <li>3. FINISH GRADE.</li> <li>4. TORO AIR/VACUUM RELIEF VALVE (T-YD-500-34).</li> <li>5. 1/2" PVC COUPLING (TxT).</li> <li>6. 6" ROUND PLASTIC VALVE BOX. HEAT BRAND "AR" ON LID IN 1" HIGH CHARACTERS.</li> <li>7. 1/2" SCH 80 PVC NIPPLE (LENGTH AS REQUIRED).</li> </ul> | <ul style="list-style-type: none"> <li>8. BRICK SUPPORTS (2 COMMON BRICKS REQUIRED).</li> <li>9. PEA GRAVEL SUMP (6" DEEP).</li> <li>10. PVC TEE (SxSxT) WITH 1/2" THREADED OUTLET.</li> <li>11. PVC PIPING.</li> </ul> <p>USE ONE AIR/RELIEF VALVE FOR EVERY 7 GPM PER ZONE. LOCATE AT HIGH POINTS.</p> |
|---|--|

**Detail No.9**  
**1/2" Air/Vacuum Relief Valve**  
**(Plumbed to PVC Tee)**

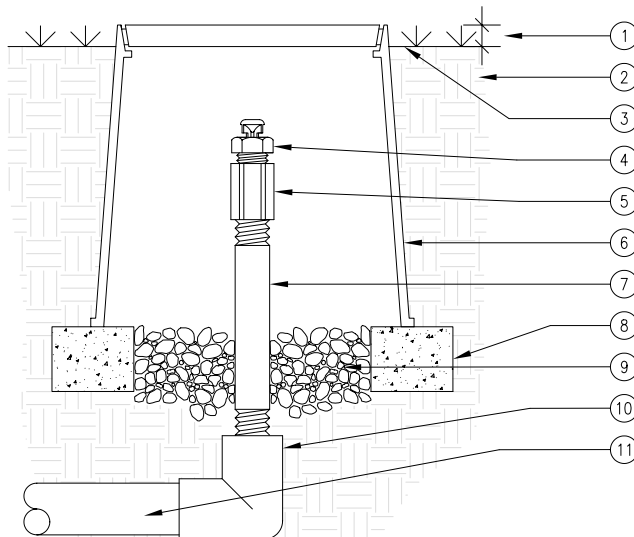

SECTION/ELEVATION

- |   |  |
|---|--|
| <ul style="list-style-type: none"> <li>1. 1" ABOVE FINISH GRADE.</li> <li>2. NATIVE SOIL PER SPECIFICATIONS.</li> <li>3. FINISH GRADE.</li> <li>4. TORO AIR/VACUUM RELIEF VALVE (T-YD-500-34).</li> <li>5. 1/2" PVC COUPLING (TxT).</li> <li>6. 6" ROUND PLASTIC VALVE BOX. HEAT BRAND "AR" ON LID IN 1" HIGH CHARACTERS.</li> <li>7. 1/2" SCH 80 PVC NIPPLE (LENGTH AS REQUIRED).</li> </ul> | <ul style="list-style-type: none"> <li>8. BRICK SUPPORTS (2 COMMON BRICKS REQUIRED).</li> <li>9. PEA GRAVEL SUMP (6" DEEP).</li> <li>10. PVC ELBOW (SxT) WITH 1/2" THREADED OUTLET.</li> <li>11. PVC PIPING.</li> </ul> <p>USE ONE AIR/RELIEF VALVE FOR EVERY 7 GPM PER ZONE. LOCATE AT HIGH POINTS.</p> |
|---|--|

**Detail No.10**  
**1/2" Air/Vacuum Relief Valve**  
**(Plumbed to PVC elbow)**

■ Recommended Installation Instructions

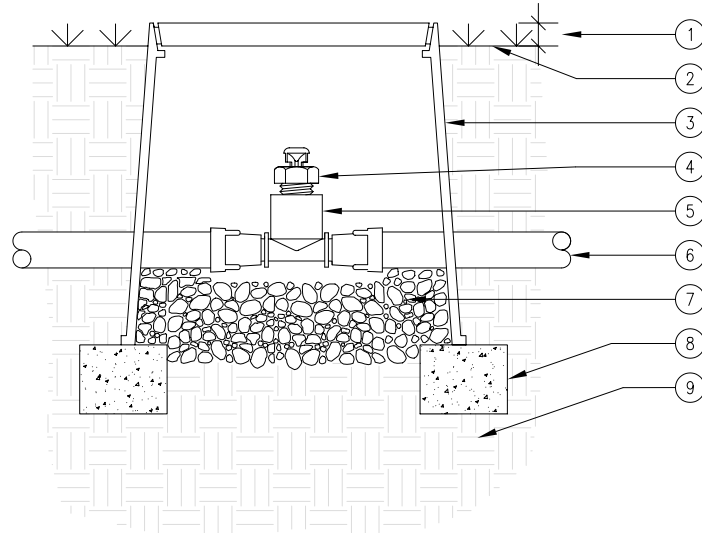

SECTION/ELEVATION

Detail No.11

1/2" Air/Vacuum Relief Valve  
(Plumbed to tubing)

- |  |   |
|--|---|
| 1. 1" ABOVE FINISH GRADE.  | 6. TORO DRIPLINE OR BLUE STRIPE POLY TUBING (T-EHD1645-XXX) AIR RELIEF LATERAL. |
| 2. FINISH GRADE.   | 7. PEA GRAVEL SUMP (6" DEEP).   |
| 3. 6" ROUND PLASTIC VALVE BOX. HEAT BRAND "AR" ON LID IN 1" HIGH CHARACTERS. | 8. BRICK SUPPORTS (2 COMMON BRICKS REQUIRED).                                   |
| 4. TORO AIR/VACUUM RELIEF VALVE (T-YD-500-34).                               | 9. NATIVE SOIL PER SPECIFICATIONS.  |
| 5. TORO LOC-EZE X 1/2" FPT TEE (T-FTF16).                                    | USE ONE AIR/RELIEF VALVE FOR EVERY 7 GPM PER ZONE. LOCATE AT HIGH POINTS.       |

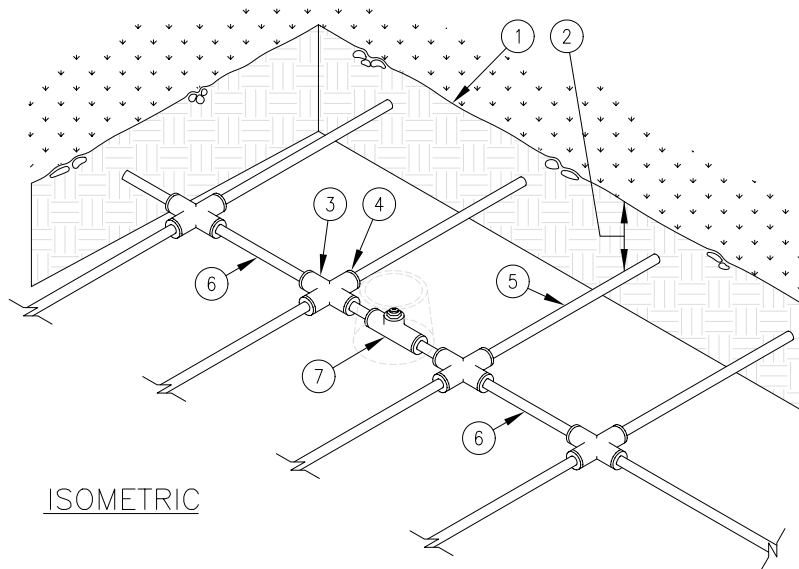

ISOMETRIC

Detail No.12

Air/Vacuum Relief lateral

- |   |  |
|---|--|
| 1. FINISH GRADE.                        | 6. AIR/VACUUM RELIEF LATERAL, TORO BLUE STRIPE POLY TUBING (T-EHD1645-XXX) CENTERED ON MOUND OR BERM.  |
| 2. DEPTH OF TUBING PER SPECIFICATIONS.  | 7. TORO AIR/VACUUM RELIEF VALVE (T-YD-500-34) AT HIGH POINT. REFER TO AIR/VACUUM RELIEF VALVE DETAILS. |
| 3. PVC CROSS (SxSxSxS).                 |  |
| 4. TORO COMPRESSION ADAPTER (T-CA-710). |  |
| 5. DRIPLINE LATERAL.                    |  |

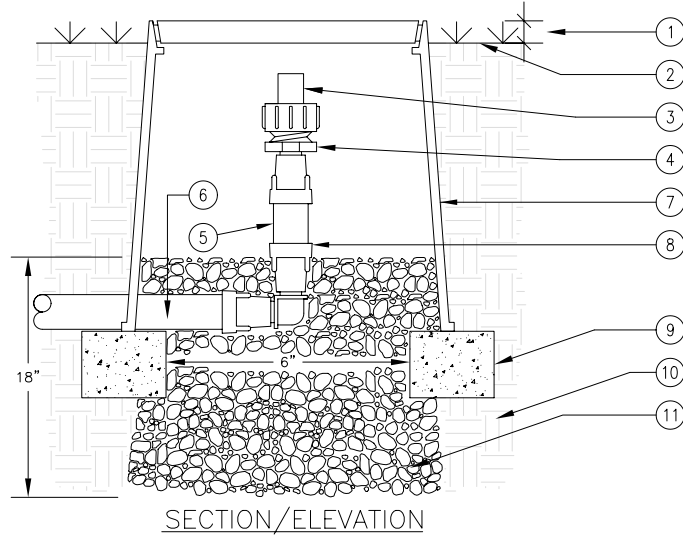

**Detail No.13**  
**Automatic Flush Valve**

- |   |  |
|---|--|
| <p>1. 1" ABOVE FINISH GRADE.</p> <p>2. FINISH GRADE.</p> <p>3. TORO FLUSH VALVE (T-FCH-H-FHT).</p> <p>4. TORO LOC-EZE X 3/4" MHT ADAPTER (T-FJA16).</p> <p>5. TORO BLUE STRIPE POLY TUBING (T-EHD1645-XXX).</p> <p>6. TORO DRIPLINE OR BLUE STRIPE POLY TUBING (T-EHD1645-XXX).</p> | <p>7. 6" ROUND PLASTIC VALVE BOX. HEAT BRAND "AR" ON LID IN 1" HIGH CHARACTERS.</p> <p>8. TORO LOC-EZE ELBOW (T-FEE16).</p> <p>9. BRICK SUPPORTS (2 COMMON BRICKS REQUIRED).</p> <p>10. NATIVE SOIL PER SPECIFICATIONS.</p> <p>11. PEA GRAVEL SUMP (6" DEEP).</p> <p>USE ONE FLUSH VALVE FOR EVERY 7 GPM PER ZONE. LOCATE AT LOW POINTS. FLUSH RATE IS 0.8 GPM. FLUSH PRESSURE IS 2 PSI.</p> |
|---|--|

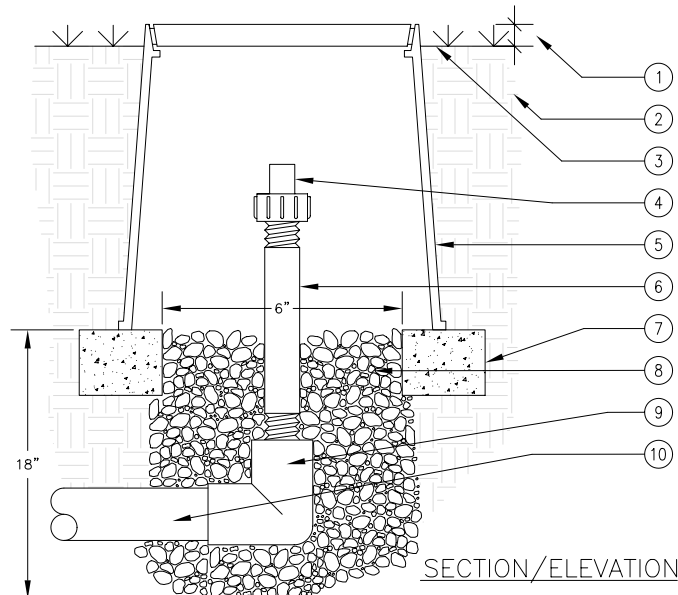

**Detail No.14**  
**Automatic Flush Valve**

- |  |  |
|--|--|
| <p>1. 1" ABOVE FINISH GRADE.</p> <p>2. NATIVE SOIL PER SPECIFICATIONS.</p> <p>3. FINISH GRADE.</p> <p>4. TORO FLUSH VALVE (T-FCH-H-FIPT).</p> <p>5. 6" ROUND PLASTIC VALVE BOX. HEAT BRAND "AR" ON LID IN 1" HIGH CHARACTERS.</p> <p>6. 3/4" SCH 80 PVC NIPPLE (LENGTH AS REQUIRED).</p> | <p>7. BRICK SUPPORTS (2 COMMON BRICKS REQUIRED).</p> <p>8. PEA GRAVEL SUMP (6" DEEP).</p> <p>9. PVC ELBOW (SxT) WITH 3/4" THREADED OUTLET.</p> <p>10. PVC PIPING.</p> <p>USE ONE FLUSH VALVE FOR EVERY 7 GPM PER ZONE. LOCATE AT LOW POINTS. FLUSH RATE IS 0.8 GPM. FLUSH PRESSURE IS 2 PSI.</p> |
|--|--|

■ Recommended Installation Instructions

Detail No.15  
End-Feed Layout

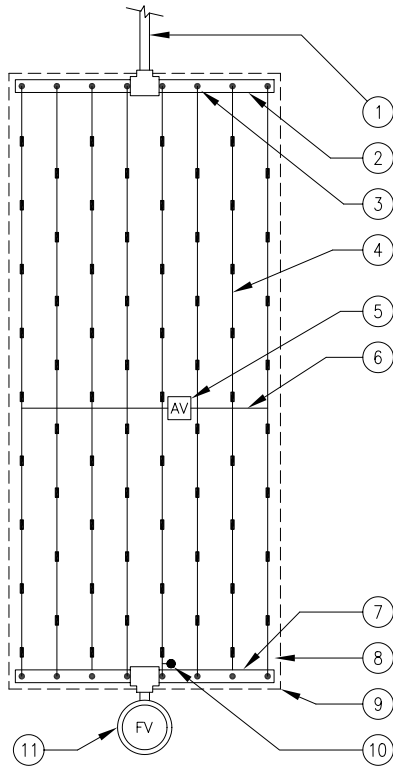

PLAN

1. PVC LATERAL LINE FROM DRIP ZONE KIT.
  2. PVC SUPPLY MANIFOLD.
  3. MANIFOLD-TO-ELBOW CONNECTION (TYP).
  4. DRIPLINE LATERAL.
  5. AIR/VACUUM RELIEF VALVE (T-YD-500-34) PLUMBED TO TORO BLUE STRIPE POLY TUBING (T-EHD1645-XXX) AT EACH HIGH POINT.\*
  6. AIR/VACUUM RELIEF LATERAL, TORO BLUE STRIPE POLY TUBING (T-EHD1645-XXX) CENTERED ON MOUND OR BERM.\*
  7. PVC FLUSH MANIFOLD.
  8. PERIMETER LATERALS 2" TO 4" FROM EDGE.
  9. AREA PERIMETER.
  10. DL2000 OPERATION INDICATOR (T-DL-MP9), OPTIONAL.\*
  11. AUTOMATIC FLUSH VALVE (T-FCH-H-FIPT) PLUMBED TO FLUSH MANIFOLD AT LOW POINT.
- \* ONLY REQUIRED ON SUBSURFACE INSTALLATIONS

Detail No.16  
Center-Feed Layout

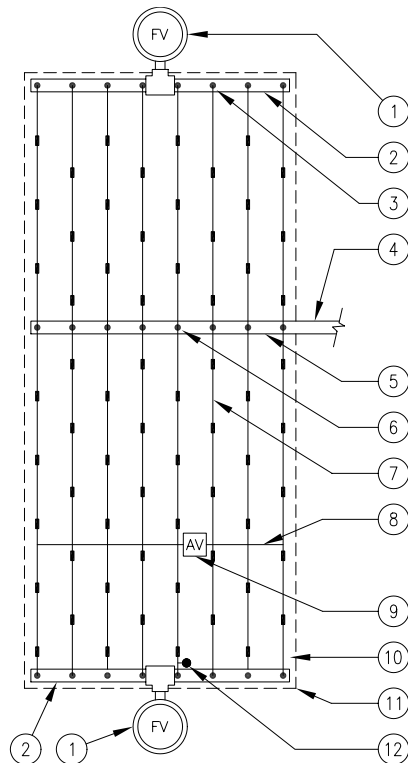

PLAN

1. AUTOMATIC FLUSH VALVE (T-FCH-H-FIPT) PLUMBED TO FLUSH MANIFOLD AT LOW POINT.
  2. PVC FLUSH MANIFOLD.
  3. MANIFOLD-TO-ELBOW CONNECTION (TYP).
  4. PVC LATERAL LINE FROM DRIP ZONE KIT.
  5. PVC SUPPLY MANIFOLD.
  6. MANIFOLD-TO-TEE CONNECTION.
  7. DRIPLINE LATERAL.
  8. AIR/VACUUM RELIEF LATERAL, TORO BLUE STRIPE POLY TUBING (T-EHD1645-XXX) CENTERED ON MOUND OR BERM.\*
  9. AIR/VACUUM RELIEF VALVE (T-YD-500-34) PLUMBED TO TORO BLUE STRIPE POLY TUBING (T-EHD1645-XXX) AT EACH HIGH POINT.\*
  10. PERIMETER LATERALS 2" TO 4" FROM EDGE.
  11. AREA PERIMETER.
  12. DL2000 OPERATION INDICATOR (T-DL-MP9), OPTIONAL.\*
- \* ONLY REQUIRED ON SUBSURFACE INSTALLATIONS



1. PVC LATERAL LINE FROM DRIP ZONE KIT.
  2. AIR/VACUUM RELIEF VALVE (T-YD-500-34) PLUMBED TO TORO BLUE STRIPE POLY TUBING (T-EHD1645-XXX) AT EACH HIGH POINT.\*
  3. PVC FLUSH MANIFOLD.
  4. INLINE SPRING CHECK VALVE (JVO500-S2) TO HELP CONTROL LOW-HEAD DRAINAGE (TYP).
  5. AIR/VACUUM RELIEF VALVE (T-YD-500-34) PLUMBED TO PVC FLUSH MANIFOLD JUST BELOW EACH CHECK VALVE.\*
  6. DRIPLINE LATERAL.
  7. PVC SUPPLY MANIFOLD
  8. MANIFOLD-TO-ELBOW CONNECTION (TYP).
  9. PERIMETER LATERALS 2" TO 4" FROM EDGE.
  10. AREA PERIMETER.
  11. DL2000 OPERATION INDICATOR (T-DL-MP9), OPTIONAL.\*
  12. AUTOMATIC FLUSH VALVE (T-FCH-H-FIPT) PLUMBED TO FLUSH MANIFOLD AT LOW POINT.
- \* ONLY REQUIRED ON SUBSURFACE INSTALLATIONS

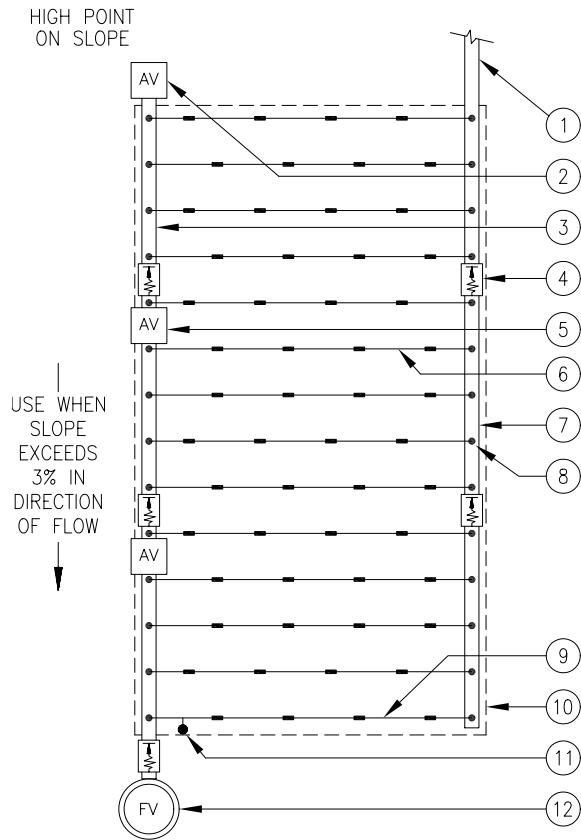

PLAN

**Detail No.17**  
Slope Layout

■ Recommended Installation Instructions

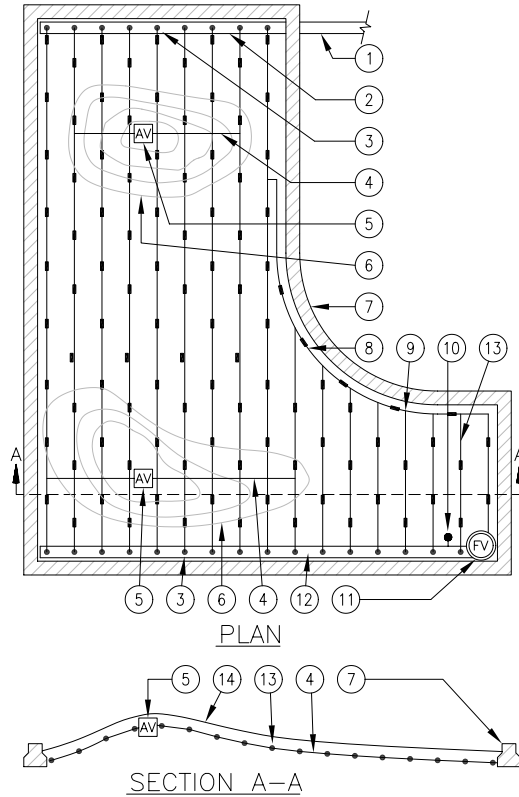

1. PVC LATERAL LINE FROM DRIP ZONE KIT.
2. PVC SUPPLY MANIFOLD.
3. TORO MANIFOLD-TO-ELBOW CONNECTION (TYP).
4. AIR/VACUUM RELIEF LATERAL, TORO BLUE STRIPE POLY TUBING (T-EHD1645-XXX) CENTERD ON MOUND OR BERM.
5. TORO AIR/VACUUM RELIEF VALVE (T-YD-500-34) PLUMBED TO TORO BLUE STRIPE POLY TUBING (T-EHD1645-XXX) AT EACH HIGH POINT.
6. BERM (TYP).
7. EDGE OF PLANTER.
8. PERIMETER LATERALS 2" TO 4" FROM EDGE.
9. TORO LOC-EZE TEE (T-FTT16).
10. TORO DL2000 OPERATION INDICATOR (T-DL-MP9). OPTIONAL.
11. TORO AUTOMATIC FLUSH VALVE (T-FCH-H-FIPT) PLUMBED TO FLUSH MANIFOLD AT LOW POINT.
12. PVC FLUSH MANIFOLD.
13. DRIPLINE LATERAL.
14. FINISHED GRADE.

Detail No.18  
Mound Layout Using  
Subsurface Dripline

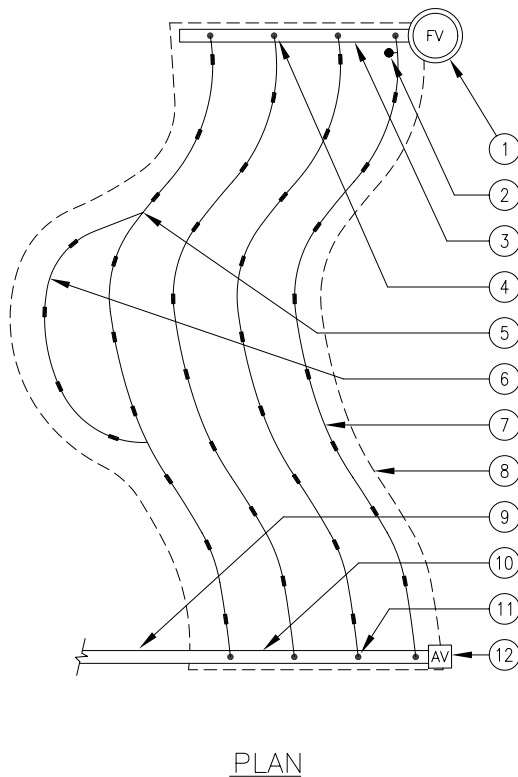

1. AUTOMATIC FLUSH VALVE (T-FCH-H-FIPT) PLUMBED TO FLUSH MANIFOLD AT LOW POINT.
2. DL2000 OPERATION INDICATOR (T-DL-MP9), OPTIONAL.\*
3. PVC FLUSH MANIFOLD
4. MANIFOLD-TO-ELBOW CONNECTION (TYP).
5. TORO LOC-EZE TEE (T-FTT16)
6. PERIMETER LATERALS 2" TO 4" FROM EDGE.
7. DRIPLINE LATERAL
8. AREA PERIMETER.
9. PVC LATERAL LINE FROM DRIP ZONE KIT.
10. PVC SUPPLY MANIFOLD.
11. MANIFOLD-TO-ELBOW CONNECTION.
12. AIR/VACUUM RELIEF VALVE (T-YD-500-34) PLUMBED TO TORO BLUE STRIPE POLY TUBING (T-EHD1645-XXX) AT EACH HIGH POINT.\*

\* ONLY REQUIRED ON SUBSURFACE INSTALLATIONS

Detail No.19  
Irregular Layout

1. AUTOMATIC FLUSH VALVE (T-FCH-H-FIPT) PLUMBED TO FLUSH MANIFOLD AT LOW POINT.
2. PVC FLUSH MANIFOLD.
3. TORO DL2000 OPERATION INDICATOR (T-DL-MP9), OPTIONAL.\*
4. MANIFOLD-TO-ELBOW CONNECTION (TYP).
5. TORO DRIPLINE LATERAL.
6. AREA PERIMETER.
7. PERIMETER LATERALS 2" TO 4" FROM EDGE.
8. PVC LATERAL LINE FROM DRIP ZONE KIT.
9. TORO LOC-EZE TEE (T-FTT16).
10. PVC SUPPLY MANIFOLD.
11. AIR/VACUUM RELIEF VALVE (T-YD-500-34) PLUMBED TO SUPPLY MANIFOLD AT HIGH POINT.\*

\*ONLY REQUIRED ON SUBSURFACE INSTALLATIONS

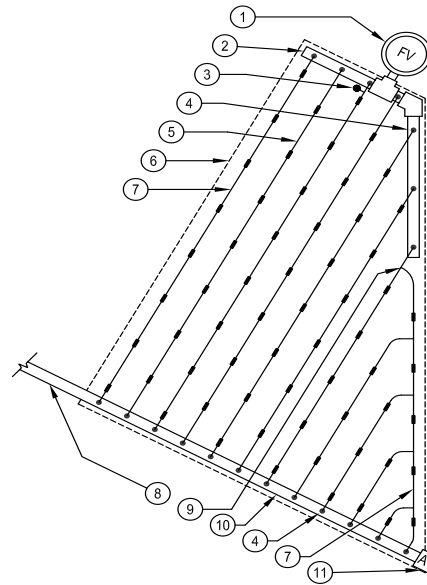

**Detail No.20**  
**Island Layout**  
**End Feed**

**PLAN**  
 NOT TO SCALE

1. PVC LATERAL LINE FROM DRIP ZONE KIT.
2. PVC SUPPLY MANIFOLD.
3. PVC TEE (SxSxS).
4. PVC ELBOW (SxS).
5. TORO LOC-EZE ELBOW (T-FEE16).
6. TORO LOC-EZE TEE (T-FTT16).
7. TORO BLUE STRIPE POLY TUBING (T-EHD1645-XXX) AT SUPPLY AND FLUSH END OF EACH ISLAND
8. TORO LOC-EZE TEE X 1/2" SLIP ADAPTER (T-FTV16).
9. AIR/VACUUM RELIEF VALVE (T-YD-500-34) PLUMBED TO TORO BLUE STRIPE POLY TUBING (T-EHD1645-XXX) AT EACH HIGH POINT.\*
10. DRIPLINE LATERAL
11. AUTOMATIC FLUSH VALVE (T-FCH-H-FIPT) PLUMBED TO FLUSH MANIFOLD AT LOW POINT.
12. DL2000 OPERATION INDICATOR (T-DL-MP9), OPTIONAL.\*
13. ISLAND PERIMETER.
14. PERIMETER LATERALS 2" TO 4" FROM EDGE.

\* ONLY REQUIRED ON SUBSURFACE INSTALLATIONS

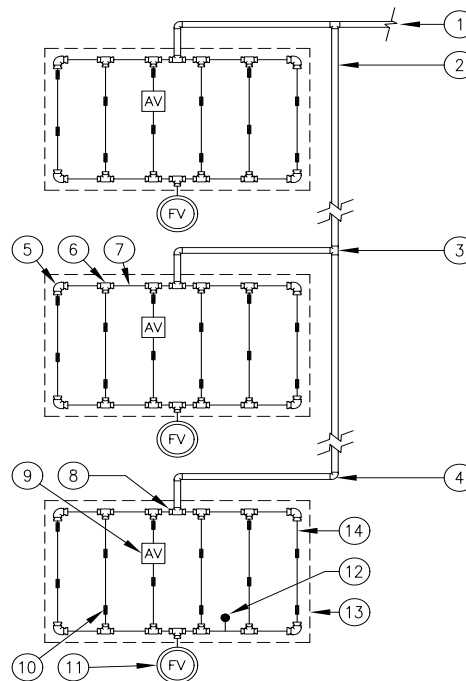

**Detail No.21**  
**Island Layout**

**PLAN**

■ Recommended Installation Instructions

Detail No.22  
Tree Layout

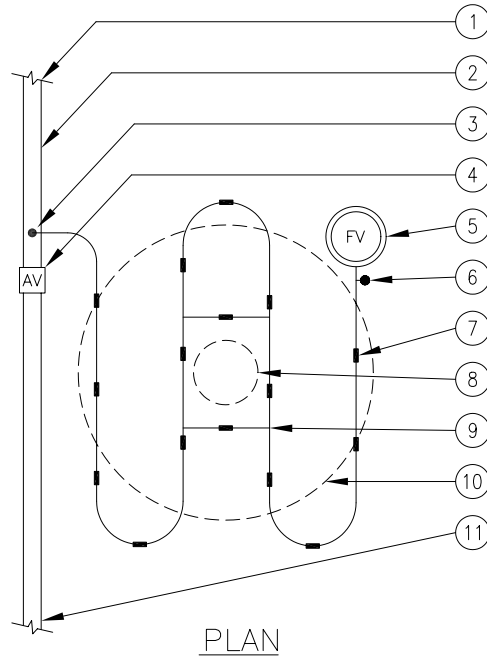

1. PVC LATERAL LINE FROM DRIP ZONE KIT.
2. PVC SUPPLY LINE.
3. MANIFOLD-TO-ELBOW CONNECTION.
4. AIR/VACUUM RELIEF VALVE (T-YD-500-34)  
PLUMBED TO TORO BLUE STRIPE POLY TUBING (T-EHD1645-XXX) AT EACH HIGH POINT.\*
5. AUTOMATIC FLUSH VALVE (T-FCH-H-FIPT)  
PLUMBED TO TUBING AT END OF EACH LINE.
6. DL2000 OPERATION INDICATOR (T-DL-MP9),  
OPTIONAL.\*
7. DRIPLINE LATERAL.
8. TREE ROOTBALL.
9. TORO LOC-EZE TEE (T-FTT16).
10. ESTIMATED DRIP LINE OF MATURE TREE.
11. PVC SUPPLY LINE TO OTHER TREES.

\* ONLY REQUIRED ON SUBSURFACE INSTALLATIONS

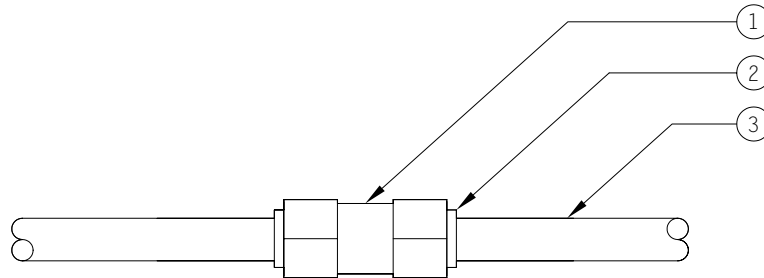

Detail No.23  
Check Valve

1. INLINE CHECK VALVE (JVO500-S2).
2. COMPRESSION ADAPTER (T-CA-710).
3. DRIPLINE

## System Inspection

Physical inspections are necessary in the following circumstances:

- At the beginning of each irrigation season
- After any landscape planting operation or renovation
- For subsurface dripline installations, after any maintenance function requiring digging at or below the dripline depth

Physically inspect system components (remote control valves, filters, automatic flush caps and flush-end pressure checks) on a routine basis as determined by historical experience.

Base zone-flow readings, supply manifold pressures and flush-end pressure readings should be recorded with all system components operating at their optimum capacity. Baseline readings after installation should be determined during the final system inspection upon initial startup. However, they can be determined at any time as long as all system components are operating properly. Record this data on the System Data Record below as a permanent reference record.

### System Data Record

- Station Number: \_\_\_\_\_
- Dripline Model Number: \_\_\_\_\_
- Emitter Spacing: \_\_\_\_\_ inches
- Emitter Flow: \_\_\_\_\_ GPH
- Dripline Spacing: \_\_\_\_\_ inches
- Initial Supply Manifold Pressure: \_\_\_\_\_ PSI
- Initial Flush Valve Pressure: \_\_\_\_\_ PSI
- Application Rate: \_\_\_\_\_ inches per hour
- Evapotranspiration Rate (inches per week):  
Jan. \_\_\_\_\_ May \_\_\_\_\_ Sept. \_\_\_\_\_  
Feb. \_\_\_\_\_ June \_\_\_\_\_ Oct. \_\_\_\_\_  
Mar. \_\_\_\_\_ July \_\_\_\_\_ Nov. \_\_\_\_\_  
Apr. \_\_\_\_\_ Aug. \_\_\_\_\_ Dec. \_\_\_\_\_

Preventative  
Maintenance

■ **Routine Preventative Maintenance**

NOTES:

**Routine Inspections Checklist**

- Turn on each zone for five to 10 minutes and walk the area, looking for excessively wet areas that might indicate leaks.
- Inspect air/vacuum relief valves (subsurface installations only) and automatic flush caps for proper operation.
- Check pressures at the supply manifold and flush ends of each zone, and compare them with the base information on the System Data Record. For proper flushing, the flush-end pressure should be at least 10 PSI.
- Check the operational flow of each zone and compare it with the design flows or the flows on the System Data Record. High flows could indicate leaks or malfunctioning automatic flush caps. Flows lower than expected could indicate clogged drippers, drippers with excessive salt build-up, kinked dripline or a clogged filter. Low flows might also indicate that the capacity of the installed remote control valves, filters or pressure regulators are too low, thus restricting the flow to the zone.

**Component Maintenance Checklists**

*Remote Control Valves*

- Upon initial inspection, check to see if the valve is properly sized for the zone flow. Refer to the manufacturer's specification. Oversized valves may not close properly and undersized valves will restrict flow and cause excessive pressure loss.
- Follow the manufacturer's recommended procedures for repair and general maintenance.
- Inspect for proper operation when opening or closing. A weeping valve can cause excessively wet areas at low points in the zone.

### *Filters*

- Filters must be inspected and cleaned periodically. The frequency of inspection is dependent on the water source. Municipal potable water may require less frequent cleaning than irrigation district water, pond water or well water. The frequency is determined by historical experience as new systems are operated.
- Commercial installations should include pressure gauges, or facilities to connect pressure gauges, immediately upstream and downstream of each filter. Filters should be cleaned when the pressure drop across the filter is 8 PSI or greater, or when the downstream pressure falls below the designed working pressure of the system.
- Filters without pressure gauges should be inspected monthly until the necessary frequency is determined.
- Filters should always be inspected when any system break occurs ahead of the filter.
- If filters are plugging too frequently, a larger filter (two times the highest zone flow) may need to be installed upstream of the zone filters to pre-filter the water supply.

### *Pressure Regulators*

- Annually check the pressure output just downstream of the regulators to ensure that the valve is operating at designed pressures.

### *Dripline*

- Inspect driplines at the air vent (subsurface installations only) and/or flush cap locations for salt build-up after the first year of operation. If necessary, inject commercially available cleansing solutions through the system at the recommended rates and continue with annual treatment. Consult with local fertilizer distributors for recommended materials and rates.
- Prior to digging in planted areas with subsurface dripline present, turn on the system long enough to create wet areas on the surface to locate the driplines.
- After cultivation or maintenance activities, turn on the system for five to 10 minutes to inspect for leaks that might have been caused by these operation

■ *Routine Preventative Maintenance*

NOTES:

**Flush Caps**

- Automatic flush caps operate by automatically flushing a small amount of water each time the system is activated. Observe the flush operation annually to ensure that flushing is occurring properly.
- The system must be flushed thoroughly after repairs or alterations are made to the irrigation components. Automatic flush caps do not allow enough water to pass through excessive debris and, therefore, must be removed in order to effect a manual flush.
- Manual flush caps should be flushed three times each irrigation season for a period of 30 to 60 seconds or until the flush water is visibly clean. More frequent flushing may be required under extremely dirty water conditions. Flushing is also necessary any time the system is repaired.



## Troubleshooting Checklists

NOTES:

### *Excessively Wet Soil Areas*

- Determine if the wet area is caused by damaged dripline. Carefully dig up the area and expose the dripline. Make a clean cut when cutting through the damaged area. If the system is a subsurface grid system, water will flow from both sides of the cut, automatically flushing any debris that may have worked its way into the dripline. While the water is running, flush both sides of the cut and repair it with the appropriate coupling.
- If the wet area is at the low side of a slope or mound and a leak is not found, the wet area is probably caused by subsurface runoff. To remedy the problem, expose the lowest line in the area. Cut the line and plug it off at both the inlet and flush manifolds.
- Localized wet areas are sometimes caused by differences in soil depth or uneven dripline depths. If uneven dripline depth is the problem, the line must be excavated and re-installed at a uniform depth. If it is caused by shallow soil conditions, it will be necessary to correct the shallow condition or wrap some of the dripper outlets in the area with electrical tape to cut off flow.
- Localized wet areas also can be caused by leaky fittings. If this is the case, the fittings are either the incorrect size or not properly secured.
- Area-wide wet areas are probably due to improper scheduling. Set the controller to apply water at rates that correspond to local evapotranspiration data. Use the Application Rate Table and the Scheduling Form provided in this manual.

### *Excessively Dry Soils*

- Check system flows and pressures to determine if the system is operating at designed pressures. If excessively low pressures are detected, follow the standard procedures for determining the cause of a pressure drop (i.e., a clogged filter).
- Localized dry soil conditions are sometimes caused by kinked or pinched dripline, or upstream leaks. Dig up the dry area and correct the situation.
- Massive dry areas can be caused by improper scheduling. Set the controller to provide the application rate that corresponds to the local evapotranspiration data. Use the Application Rate Table and Scheduling Form provided in this manual.

# System Components

## DL2000® Drip Tubing

### Specifications

- Minimum operating pressure: 15 PSI
- Maximum operating pressure: 60 PSI
- Coefficient of variance (Cv):
  - pressure compensating: < .05
  - non-pressure compensating: .03
- Emitter outlet: Dual/opposing
- Emitter flow @ 20 PSI:
  - RGP-2XX-XX 0.53 GPH
  - RGP-4XX-XX 1.02 GPH
- Emitter spacing:
  - RGX-X12-XX 12"
  - RGX-X18-XX 18"
- Maximum length of run:
  - RGP-212-XX 360' @ 25 PSI  
460' @ 40 PSI
  - RGP-412-XX 240' @ 25 PSI  
300' @ 40 PSI
  - RGP-218-XX 515' @ 25 PSI  
650' @ 40 PSI
  - RGP-418-XX 340' @ 25 PSI  
430' @ 40 PSI
- Dimensions (L x I.D x O.D.):
  - RGP-XXX-01 100' x .620" x .710"
  - RGP-XXX-05 500' x .620" x .710"
  - RGP-XXX-10 1000' x .620" x .710"
- Weight:
  - RGP-XXX-01 4 lbs.
  - RGP-XXX-05 20 lbs.
  - RGP-XXX-10 45 lbs.

## Drip In® Drip Tubing

### Specifications

- Minimum operating pressure: 15 PSI
- Maximum operating pressure: 60 PSI
- Coefficient of variance (Cv):
  - pressure compensating: < .05
  - non-pressure compensating: .03
- Emitter outlet: Dual/opposing
- Emitter flow @ 20 PSI:
  - T-PCB1853-XX-XXX 0.53 GPH
  - T-PCB1810-XX-XXX 1.02 GPH
- Emitter spacing:
  - T-PCB18XX-12-XXX 12"
  - T-PCB18XX-18-XXX 18"
- Maximum length of run:
  - T-PCB1853-12-XXX 360' @ 25 PSI  
460' @ 40 PSI
  - T-PCB1810-12-XXX 240' @ 25 PSI  
300' @ 40 PSI
  - T-PCB1853-18-XXX 515' @ 25 PSI  
650' @ 40 PSI
  - T-PCB1810-18-XXX 340' @ 25 PSI  
430' @ 40 PSI
- Dimensions (L x I.D x O.D.):
  - T-PCB18XX-XX-100 100' x .620" x .710"
  - T-PCB18XX-XX-250 250' x .620" x .710"
  - T-PCB18XX-XX-500 500' x .620" x .710"
- Weight:
  - T-PCB18XX-XX-100 4 lbs.
  - T-PCB18XX-XX-250 9 lbs.
  - T-PCB18XX-XX-500 20 lbs.

## Plastic Y-Filters

### Specifications

- Screen mesh size: 150 mesh
- Screen material: Stainless steel
- Maximum pressure: All models 142 PSI
- Maximum flow rate:
  - T-ALFS75150-L 25 GPM
  - T-ALFS10150-L 35 GPM
- Body dimensions (L x W x D):
  - T-ALFS75150-L: 9" x 7.32" x 4.29"
  - T-ALFS10150-L: 9" x 7.32" x 4.29"
- Inlet/outlet size:
  - T-ALFS75150-L 3/4" MIPT
  - T-ALFS10150-L 1" MIPT

NOTES:

**DL2000® Flushing Cap**

*Specifications*

- Part Number: T-CEFCH-H
- Sealing pressure: 2 PSI
- Flush rate: 0.8 GPM
- Maximum operating pressure: 50 PSI
- Outlet size: .710" O.D. compression
- Body dimensions (L x W x D):  
3.425" x 1.340" x 1.340
- Weight: 0.8 oz.

**DL2000 Pressure Regulators**

*Specifications*

- Flow rate:
  - T-PMR15-LF 1/10 - 8 GPM  
(6 - 480 GPH)
  - T-PMR25-LF 1/10 - 8 GPM  
(6 - 480 GPH)
  - T-PMR25-MF 2 - 20 GPM  
(120 - 1200 GPH)
  - T-PR25-HF 10 - 32 GPM  
(600 - 1920 GPH)
  - T-PMR40-MF 2 - 20 GPM  
(120 - 1200 GPH)
- Pressure regulation:
  - T-PMR15-XX 15 PSI +/- 6%
  - T-PMR25-XX 25 PSI +/- 6%
  - T-PMR40-XX 40 PSI +/- 6%
- Maximum pressure:
  - T-PMRXX-XX 150 PSI
  - T-PR25-HF 95 PSI
- Body dimensions (L x W x D):
  - T-PMR15-LF 4.60" x 2.16" x 2.16"
  - T-PMR25-LF 4.60" x 2.16" x 2.16"
  - T-PMR25-MF 5.15" x 2.50" x 2.50"
  - T-PR25-HF 5.54" x 2.92" x 2.92"
  - T-PMR40-MF 5.15" x 2.50" x 2.50"
- Inlet/outlet size:
  - T-PMR15-LF 3/4" FIPT
  - T-PMR25-LF 3/4" FIPT
  - T-PMR25-MF 3/4" FIPT
  - T-PR25-HF 1" FIPT
  - T-PMR40-MF 3/4" FIPT
- Weight:
  - T-PMR15-LF 4.85 oz.
  - T-PMR25-LF 4.85 oz.
  - T-PMR25-MF 6.70 oz.
  - T-PR25-HF 9.35 oz.
  - T-PMR40-MF 6.70 oz.

**DL2000 Air Vent/Vacuum Relief Valve**

*Specifications*

- Part Number: T-YD-500-34
- Vent closing pressure: 4 PSI
- Vacuum relief pressure: 4 PSI
- Maximum operating pressure: 100 PSI
- Inlet thread size: 1/2" MIPT
- Body dimensions (L x W x D):  
1.460" x .980" x .980"
- Weight: .25 oz.

**Compression Adapter**

- Part Number: T-CA-710
- Minimum operating pressure: 5 PSI
- Maximum operating pressure: 50 PSI
- Inlet size: .850" O.D. (solvent-welds to  
1/2" female slip fitting)
- Outlet connection size: Accepts .710"  
O.D. tubing
- Body dimensions (L x W x D):  
.560" x .970" x .970"
- Weight: .05 oz.

NOTES:

**Loc-Eze Coupling**

**Specifications**

- Part Number: T-FCC16
- Minimum operating pressure: 5 PSI
- Maximum operating pressure: 50 PSI
- Connection size:  
Accepts .620" I.D. tubing
- Body dimensions (L x W x D):  
2.100" x .720" x .720"
- Weight: .25 oz.

**1/4" Dripline**

**Specifications**

- Configurations/Part Numbers:  
**DL2000 Microline**
  - 6": T-MCRG-206
  - 12": T-MCRG-212
- Soakerline**
  - 6": T-SDB252-6-100
  - 12": T-SDB252-12-100
- Emitter flow: .53 GPH
- Emitter spacing: 6" and 12"
- Emitter outlet: Dual/opposing
- Coefficient of variance (Cv): .07
- Minimum operating pressure: 15 PSI
- Maximum operating pressure: 60 PSI
- Maximum length of run: 19' and 33'
- Dimensions (L x I.D x O.D.):  
100' x .170" x .250"
- Weight: .75 lbs.

**1/4" Barbed Fittings**

**Specifications**

- Configurations/Part Numbers:
  - Tee: T-FTT0400
  - Elbow: T-FEE0400
  - Coupling: T-FCC0400
- Maximum operating pressure: 60 PSI
- Connection size:  
Accepts .170" I.D. tubing
- Body dimensions (L x W x D):
  - T-FTT0400 1.410" x .835" x .250"
  - T-FEE0400 .825" x .825" x .250"
  - T-FCC0400 .730" x .435" x .435"
- Weight:
  - T-FTT0400 .9 gram
  - T-FEE0400 .6 gram
  - T-FCC0400 .4 gram

**Dual Goof Plug**

- Part Number: T-FPG02
- Maximum operating pressure: 60 PSI
- Connection size: Plugs .170" and/or .250" diameter holes
- Body dimensions (L x W x D):  
.735" x .360" x .360"
- Weight: .5 gram

**Micro Valve**

- Part Number: T-FCV-BB
- Maximum operating pressure: 60 PSI
- Flow rate @ 15 PSI: 0 - .47 GPM  
(0 - 28.2 GPH)
- Inlet/outlet connection size:  
.170" I.D. tubing
- Body dimensions (L x W x D):  
1.450" x 1.070" x .290"
- Weight: 2 grams

## **Optional Components**

### ***Irrigation Controller***

To maximize the efficiency of your subsurface drip system, choose a controller which allows multiple start times. For small, one-valve installations, battery-operated timers may be mounted directly onto the supply line. For larger, multi-valve installations, an irrigation controller may be rewired. Typical controllers have 6 to 12 stations. Some controllers have a battery backup in the event of a power failure. Choose a controller that can expand with your landscape needs.

### ***Fertilizer Injector***

One of the main advantages of subsurface drip irrigation is that fertilizers and other chemicals can be applied safely through the system. Injectors must be installed downstream of the backflow prevention device and upstream of the filter. An injector can be used to keep driplines clean by injecting cleaning solutions.

### ***Water Meter***

Water meters can be used to diagnose problems as well as to schedule irrigation times.

### ***Soil Moisture Sensor***

Soil moisture sensors override the timer if there is too little or too much water in the soil. There is no need to adjust watering schedules to climate changes. Moisture sensors can be used to control individual valves or to override the whole irrigation controller. Sensors should be installed at the driest areas in the field.

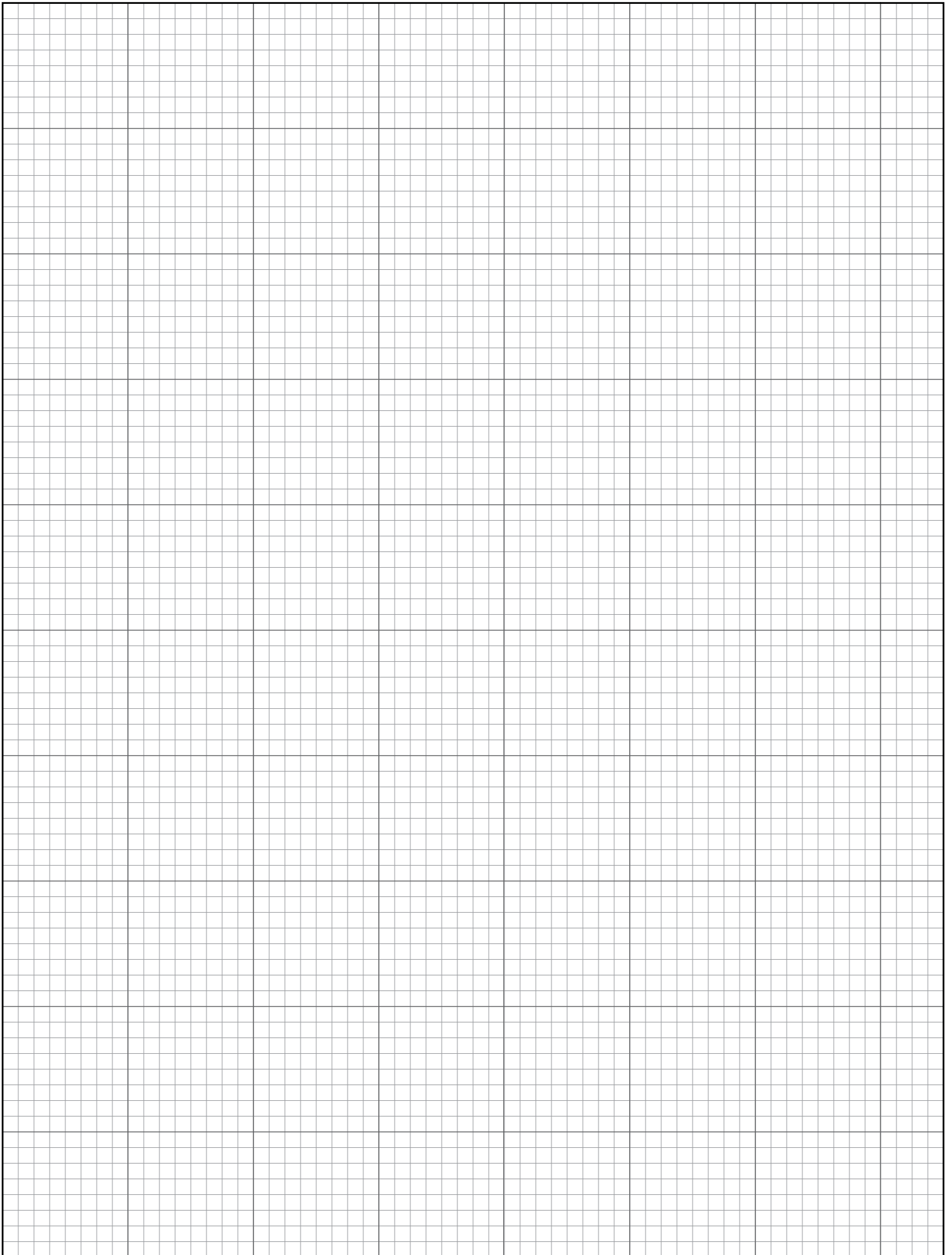



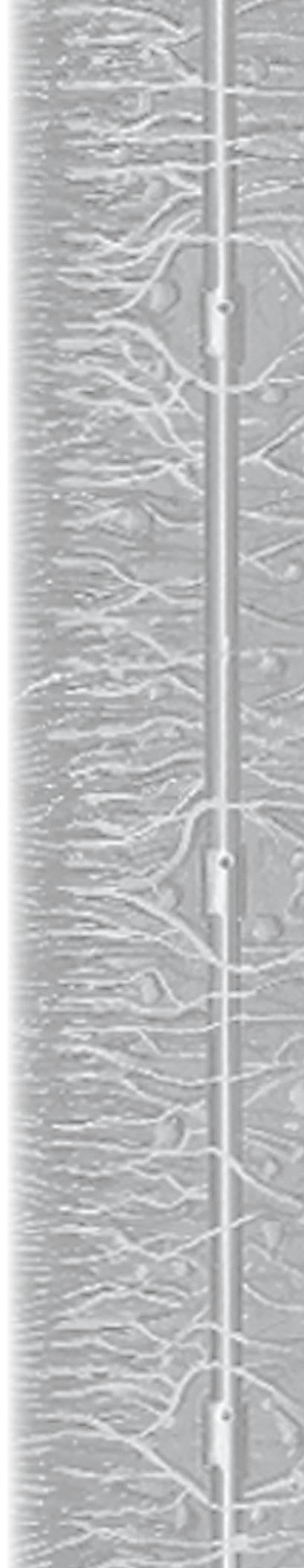

**The Toro Company • Irrigation Division**

5825 Jasmine St. • Riverside, CA • 92504 • Phone (877) 345-8676 • [www.toro.com](http://www.toro.com)  
Form No. 10-1092-IRC ©2011 The Toro Company • All Rights Reserved

We reserve the right to improve our products and make changes in the specifications and designs without notice and without incurring obligation.